



# 2024 Product Catalog





# Bring something spectacular to the table.

American Metalcraft products elevate food service in every form—restaurants, grocery stores, hotels and catered events alike. To see the difference that incredible presentation can make, look to the little things. Whether we're making barware or buffetware, we find opportunities to incorporate unique details, exceptional functionality and on-trend designs. Our goal is always to make your culinary creations the best possible versions of themselves.

Over seventy-five years ago, we broke into the industry by turning hubcaps into deep-dish pizza pans and custom plate covers. We've since grown our product line into an expansive, eclectic collection of food presentation solutions. In these pages, you'll discover creative tabletop accessories, innovative kitchen supplies and every other tool you need to craft an incredible dining experience. **It all boils down to this: Great food deserves great presentation.**





Dinnerware <sup>9-48</sup>

Tabletop Accessories <sup>49-166</sup>

Buffet & Display <sup>167-330</sup>

Bar Supplies <sup>331-376</sup>

Kitchen Supplies <sup>377-398</sup>

Pizza Pans & Supplies <sup>399-453</sup>

### Symbols



Products that are new to our catalog in 2024.



Products that are among our best sellers.



Products that are available in retail packaging or with a retail hang tag.



Products that should be hand washed only.



Products that are economically shipped knocked down. May require assembly.



Products that have received NSF certification and meet strict standards for public health protection.



Products manufactured in the United States of America.



Products that do not contain Bisphenol-A.



**WARNING:** Products that may contain chemicals known to the state of California to cause cancer, birth defects or other reproductive harm. For more information, go to [www.P65Warnings.ca.gov](http://www.P65Warnings.ca.gov).



**Great food deserves great presentation.**

Check out some of our new product highlights.



**36**  
**Ani Collection**

An incredibly sleek and affordable dinnerware line.



# 225

## Lift Collection Tiered Stands



Take presentation to new heights with these adjustable stands. Customize for a one-tier, two-tier or three-tier stand. Features plates with a reversible design.

# 192

## Amano Buffetware



Each piece is hand forged of durable stainless steel for a unique and sophisticated look.

# 145

## Marble Bud Vases



These simple yet elegant bud vases are designed to make flowers pop.



## BUILDING BLOCKS



**284**

Black Twilight Collection Modular Risers



**186**

Acacia Wood Juice Dispenser Base





Building a customized buffet display has never been easier with our **Black Twilight Collection Modular Risers**. Designed to adapt to changing menu needs, each riser can expand a display taller, wider or longer to serve anything from a small luncheon to a large dinner party. Further personalize the look with complementary platters available in different lengths and finishes.



**257**

Acacia Wood Serving Platters



**234**

White Marble Melamine Serving Platters





**186**

Upton Collection Juice Dispenser Base



Give a beverage station an instant upgrade with this beautiful wood base.

**250**

Upton Collection Plates



Espresso-finished wood plates feature a rimmed design to frame any menu option.

**251**

Upton Collection Platters



These stately espresso-finished wood platters pair perfectly with the Black Twilight Modular Risers.

# Dinnerware







## THE UNITY COLLECTION

Finally, a contemporary take on melamine dinnerware that provides the ultimate canvas for today's modern cuisine: the Unity Collection. Named for the intersection of form and function, the Unity Collection combines a clean, straight-sided and stackable design with the durability of melamine. The result is delectably inspiring.

Available in a wide variety of shapes, sizes, and capacities, this dual-toned collection features colorways to approach both the coolest and warmest of decors. Intermix the graphite and mocha colors together, add a splash of stainless and a touch of Tritan™ and your recipe is complete. The look is truly extraordinary.







# THE UNITY COLLECTION



Graphite  
(GE)



Mocha  
(MO)

Please add **GE** for Graphite or **MO** for Mocha to the end of the item number to designate color choice when ordering.



**Square Plate**  
**UPS11GE** Graphite  
**UPS11MO** Mocha  
 11" Sq. x ½" H (27.9 x 1.3 cm)



**Square Plate**  
**UPS9GE** Graphite  
**UPS9MO** Mocha  
 9" Sq. x ½" H (22.9 x 1.3 cm)



**Square Plate**  
**UPS6GE** Graphite  
**UPS6MO** Mocha  
 6" Sq. x ½" H (15.2 x 1.3 cm)



**Rectangular Serving Platter**  
**UPLS10GE** Graphite  
**UPLS10MO** Mocha  
 10" L x 4 ¾" W x ⅞" H (25.4 x 12.1 x 2.2 cm)



**Square Serving Bowl/Tray**  
**UBS60GE** Graphite  
**UBS60MO** Mocha  
 60 oz. (1.8 L)  
 10" Sq. x 1 ½" H (25.4 x 3.8 cm)



**Square Bowl**  
**UBS16GE** Graphite  
**UBS16MO** Mocha  
 16 oz. (473.2 mL)  
 4 ½" Sq. x 2" H (11.4 x 5.1 cm)



**Square Bowl**  
**UBS10GE** Graphite  
**UBS10MO** Mocha  
 10 oz. (295.7 mL)  
 3 ⅝" Sq. x 2" H (9.2 x 5.1 cm)



**Square Sauce Cup**  
**USCS2GE** Graphite  
**USCS2MO** Mocha  
 2 oz. (59.1 mL)  
 2" Sq. x 1 ⅝" H (5.1 x 4.1 cm)



**Stackable Mug**  
**UM12GE** Graphite  
**UM12MO** Mocha  
 12 oz. (354.9 mL)  
 3 ⅞" Dia. x 4 ⅛" H (7.9 x 10.5 cm)



**Round Plate**  
**UPR11GE** Graphite  
**UPR11MO** Mocha  
 11" Dia. x ½" H (27.9 x 1.3 cm)



**Round Plate**  
**UBR9GE** Graphite  
**UBR9MO** Mocha  
 9" Dia. x ½" H (22.9 x 1.3 cm)



**Round Plate**  
**UPR6GE** Graphite  
**UPR6MO** Mocha  
 6" Dia. x ½" H (15.2 x 1.3 cm)



**Oval Serving Platter**  
**UPLR10GE** Graphite  
**UPLR10MO** Mocha  
 10 ½" L x 5 ¼" W x ¾" H (26.7 x 13.3 x 2.2 cm)



**Round Serving Bowl/Tray**  
**UBR48GE** Graphite  
**UBR48MO** Mocha  
 48 oz. (1.4 L)  
 10" Dia. x 1 ½" H (25.4 x 3.8 cm)



**Round Bowl**  
**UBR32GE** Graphite  
**UBR32MO** Mocha  
 32 oz. (946.4 mL)  
 6 ¼" Dia. x 2 ½" H (15.9 x 6.4 cm)



**Round Bowl**  
**UBR24GE** Graphite  
**UBR24MO** Mocha  
 24 oz. (709.8 mL)  
 5 ¾" Dia. x 2 ¼" H (14.6 x 5.7 cm)



**Tapered Bowl**  
**UBRT24GE** Graphite  
**UBRT24MO** Mocha  
 24 oz. (709.8 mL)  
 5 ⅝" Dia. x 2 ⅝" H (14.3 x 6.7 cm)



**Round Bowl**  
**UBR16GE** Graphite  
**UBR16MO** Mocha  
 16 oz. (473.2 mL)  
 5 ½" Dia. x 2" H (13 x 5.1 cm)



**Tapered Bowl**  
**UBRT16GE** Graphite  
**UBRT16MO** Mocha  
 16 oz. (473.2 mL)  
 5" Dia. x 2 ⅜" H (12.7 x 6 cm)



**Round Bowl**  
**UBR10GE** Graphite  
**UBR10MO** Mocha  
 10 oz. (295.7 mL)  
 4 ¼" Dia. x 2" H (10.8 x 5.1 cm)



**Tapered Bowl**  
**UBRT10GE** Graphite  
**UBRT10MO** Mocha  
 10 oz. (295.7 mL)  
 4 ⅜" Dia. x 2" H (11.1 x 5.1 cm)



**Round Bowl**  
**UBR5GE** Graphite  
**UBR5MO** Mocha  
 5 oz. (147.9 mL)  
 3 ⅝" Dia. x 1 ⅝" H (9.2 x 4.1 cm)



**Round Sauce Cup**  
**USCR2GE** Graphite  
**USCR2MO** Mocha  
 2 oz. (59.1 mL)  
 2 ½" Dia. x 1 ⅝" H (6.4 x 4.1 cm)





# THE UNITY COLLECTION

Who says that flatware should be the only touch of silver at a place setting? The Unity Collection's satin-finished stainless steel plates and bowls not only bring together form and function at the table, but they unite different materials in a beautiful marriage of modern sophistication. Use as the star of the show or as a beautiful accessory; each piece is beautifully designed to add a bit of sparkle to your meal.



**Plate**  
**SMP11** Satin Finish  
 11" Dia. x 1/2" H (27.9 x 1.3 cm)



**Plate**  
**SMP9** Satin Finish  
 9" Dia. x 1/2" H (22.9 x 1.3 cm)



**Plate**  
**SMP6** Satin Finish  
 6" Dia. x 1/2" H (15.2 x 1.3 cm)



**Plate**  
**SMP4** Satin Finish  
 4" Dia. x 1/2" H (10.2 x 1.3 cm)



**Bowl/Tray**  
**SMB10** Satin Finish  
 60 oz. (1.8 L)  
 10" Dia. x 1 1/2" H (25.4 x 3.8 cm)



**Bowl**  
**SMB6** Satin Finish  
 29 oz. (857.6 mL)  
 6" Dia. x 2" H (15.2 x 5.1 cm)



**Bowl**  
**SMB5** Satin Finish  
 15 oz. (443.6 mL)  
 5" Dia. x 1 1/4" H (12.7 x 3.2 cm)



**Bowl**  
**SMB4** Satin Finish  
 8 oz. (236.6 mL)  
 4" Dia. x 1 1/4" H (10.2 x 3.2 cm)



**Bowl**  
**SMB3** Satin Finish  
 4 oz. (118.3 mL)  
 3" Dia. x 1" H (7.6 x 2.5 cm)





# THE MIX & MATTE COLLECTION



When laid-back presentation won't cut it, our Mix & Matte Collection of melamine dinnerware lends an air of luxury. Designed to be mixed and matched, these matte pieces can stand up to even the noblest menu items.



Please add **WH** for White, **MA** for Marble, **GR** for Gray or **GM** for Gray Marble to the end of the item number to designate color choice when ordering.



**Coupe Plate**  
**MCP11WH** White    **MCP11MA** Marble  
**MCP11GR** Gray    **MCP11GM** Gray Marble  
 11 ½" Dia. x 1" H (29.2 x 2.5 cm)



**Coupe Plate**  
**MCP9WH** White    **MCP9MA** Marble  
**MCP9GR** Gray    **MCP9GM** Gray Marble  
 9" Dia. x 1" H (22.9 x 2.5 cm)



**Coupe Plate**  
**MCP6WH** White    **MCP6MA** Marble  
**MCP6GR** Gray    **MCP6GM** Gray Marble  
 6" Dia. x ⅝" H (15.2 x 1.6 cm)



**Rectangular Platter**  
**MCP12WH** White    **MCP12MA** Marble  
**MCP12GR** Gray    **MCP12GM** Gray Marble  
 12" L x 7" W x 1" H (30.5 x 17.8 x 2.5 cm)



**Coupe Bowl**  
**MCB36WH** White    **MCB36MA** Marble  
**MCB36GR** Gray    **MCB36GM** Gray Marble  
 36 oz. (1.1 L)  
 8 ¾" Dia. x 2" H (22.2 x 5.1 cm)



**Coupe Bowl**  
**MCB24WH** White    **MCB24MA** Marble  
**MCB24GR** Gray    **MCB24GM** Gray Marble  
 24 oz. (709.8 mL)  
 7 ½" Dia. x 1 ¾" H (19 x 4.4 cm)



**Coupe Bowl**  
**MCB16WH** White    **MCB16MA** Marble  
**MCB16GR** Gray    **MCB16GM** Gray Marble  
 16 oz. (473.2 mL)  
 6 ½" Dia. x 1 ½" H (16.5 x 3.8 cm)



**Coupe Bowl**  
**MCB12WH** White    **MCB12MA** Marble  
**MCB12GR** Gray    **MCB12GM** Gray Marble  
 12 oz. (354.9 mL)  
 6" Dia. x 1 ½" H (15.2 x 3.8 cm)



**Bouillon Cup**  
**MCB10WH** White    **MCB10MA** Marble  
**MCB10GR** Gray    **MCB10GM** Gray Marble  
 10 oz. (295.7 mL)  
 4 ½" Dia. x 2 ¼" H (11.4 x 5.7 cm)



**Mug**  
**MM12WH** White  
 12 oz. (354.9 mL)  
 3 ⅞" Dia. x 4 ⅛" H (7.9 x 10.5 cm)





# THE COUPE COLLECTION

Elegant yet simple, the Coupe Collection offers a level of subtle refinement to the tabletop. Available in a wide array of popular sizes, this satin-finished line of stainless steel dinnerware is a versatile (yet durable) suggestion in modern dinnerware. Use as a charger, a dinner plate, a tray, a coaster - the options are endless.



**Coupe Plate**  
**SSP16** Satin Finish  
 16" Dia. x  $\frac{3}{8}$ " H (40.6 x 1 cm)



**Coupe Plate**  
**SSP15** Satin Finish  
 15" Dia. x  $\frac{3}{8}$ " H (38.1 x 1 cm)



**Coupe Plate**  
**SSP14** Satin Finish  
 14" Dia. x  $\frac{3}{8}$ " H (35.6 x 1 cm)



**Coupe Plate**  
**SSP13** Satin Finish  
 13" Dia. x  $\frac{3}{8}$ " H (33 x 1 cm)



**Coupe Plate**  
**SSP12** Satin Finish  
 12" Dia. x  $\frac{3}{8}$ " H (30.5 x 1 cm)



**Coupe Plate**  
**SSP10** Satin Finish  
 10  $\frac{1}{2}$ " Dia. x  $\frac{3}{8}$ " H (26.7 x 1 cm)



**Coupe Plate**  
**SSP9** Satin Finish  
 9" Dia. x  $\frac{3}{8}$ " H (22.9 x 1 cm)



**Coupe Plate**  
**SSP8** Satin Finish  
 8" Dia. x  $\frac{3}{8}$ " H (20.3 x 1 cm)



**Coupe Plate**  
**SSP6** Satin Finish  
 6" Dia. x  $\frac{3}{8}$ " H (15.2 x 1 cm)



**Coupe Plate**  
**SSP4** Satin Finish  
 4" Dia. x  $\frac{3}{8}$ " H (10.2 x 1 cm)





## THE CRAVE COLLECTION

Our Crave Collection of break-resistant melamine dinnerware is back and bigger than ever. In a wide variety of plates, platters, bowls and mugs, this is not your grandma's melamine. Fast forward, rather, to the 21st century, where technological advancements in designs, materials, and manufacturing techniques create artisan-quality melamine that captures the look and feel of china—all at a fraction of the cost and two to three times the service life.

NSF-certified and BPA-free, the Crave Collection is safe in terms of durability, design, and ability to be thoroughly sanitized. In two base colors and new additional color options, each artisanally designed piece features organic edges to elevate foodservice everywhere.



HOT



HOT



Top to bottom:  
CBL16CL, CP7SH, CP10CL



# THE CRAVE COLLECTION

HOT

NSF

BPA FREE



Cloud  
(CL)



Shadow  
(SH)

Please add **CL** for Cloud or **SH** for Shadow to the end of the item number to designate color choice when ordering.



**Coupe Plate**  
CP10CL Cloud CP10SH Shadow  
11 1/8" Dia. x 3/4" H (28.3 x 1.9 cm)



**Coupe Plate**  
CP9CL Cloud CP9SH Shadow  
9" Dia. x 1" H (22.9 x 2.5 cm)



**Coupe Plate**  
CP7CL Cloud CP7SH Shadow  
7 1/2" Dia. x 7/8" H (19.1 x 2.2 cm)



**Coupe B&B Plate**  
CP6CL Cloud CP6SH Shadow  
6 1/2" Dia. x 3/4" H (16.5 x 1.9 cm)



**Rectangular Platter**  
CP12CL Cloud CP12SH Shadow  
12" L x 7 1/8" W x 1" H (30.5 x 18.1 x 2.5 cm)



**Oval Serving Platter**  
CPL12CL Cloud CPL12SH Shadow  
12" L x 9" W x 7/8" H (30.5 x 22.9 x 2.2 cm)



**Serving Bowl**  
CBL95CL Cloud CBL95SH Shadow  
95 oz. (2.8 L)  
13 1/2" Dia. x 2 1/4" H (34.3 x 5.7 cm)



**Coupe Bowl**  
CBL20CL Cloud CBL20SH Shadow  
20 oz. (591.5 mL)  
9" Dia. x 1 1/2" H (22.9 x 3.8 cm)



**Coupe Bowl**  
CBL16CL Cloud CBL16SH Shadow  
16 oz. (473.2 mL)  
8 1/2" Dia. x 1 1/2" H (21.6 x 3.8 cm)



**Coupe Bowl**  
CBL13CL Cloud CBL13SH Shadow  
13 oz. (384.5 mL)  
7" Dia. x 1 1/2" H (17.8 x 3.8 cm)



**Coupe Bowl**  
CBL8CL Cloud CBL8SH Shadow  
8 oz. (236.6 mL)  
6" Dia. x 1 1/4" H (15.2 x 3.2 cm)



**Noodle Bowl**  
**CBL50CL** Cloud      **CBL50SH** Shadow  
 50 oz. (1.5 L)  
 7 1/2" Dia. x 4 3/4" H (19.1 x 12.1 cm)



**Noodle Bowl**  
**CBL40CL** Cloud      **CBL40SH** Shadow  
 40 oz. (1.2 L)  
 7 1/8" Dia. x 4 1/4" H (18.1 x 10.8 cm)



**Bowl**  
**CBL32CL** Cloud      **CBL32SH** Shadow  
 32 oz. (946.4 mL)  
 7 1/8" Dia. x 2 1/2" H (18.1 x 6.4 cm)



**Bowl**  
**CBL24CL** Cloud      **CBL24SH** Shadow  
 24 oz. (709.8 mL)  
 6 1/2" Dia. x 2 1/4" H (16.5 x 5.7 cm)



**Soup/Salad Bowl**  
**CBL16CL** Cloud      **CBL16SH** Shadow  
 16 oz. (473.2 mL)  
 6" Dia. x 2" H (15.2 x 5.1 cm)



**Nappy Bowl**  
**CBL12CL** Cloud      **CBL12SH** Shadow  
 12 oz. (354.9 mL)  
 5 3/4" Dia. x 1 3/4" H (14.6 x 4.4 cm)



**Bouillon Cup**  
**CBC10CL** Cloud      **CBC10SH** Shadow  
 10 oz. (295.7 mL)  
 4 1/2" Dia. x 2 1/8" H (11.4 x 5.4 cm)



**Bouillon Cup**  
**CBC7CL** Cloud      **CBC7SH** Shadow  
 7 oz. (207 mL)  
 4" Dia. x 2" H (10.2 x 5.1 cm)



**Fruit Bowl**  
**CBL4CL** Cloud      **CBL4SH** Shadow  
 4 1/2 oz. (133.1 mL)  
 4" Dia. x 1 1/2" H (10.2 x 3.8 cm)



**Sauce Cup**  
**CSC4CL** Cloud      **CSC4SH** Shadow  
 4 1/2 oz. (133.1 mL)  
 3 1/4" Dia. x 2" H (8.3 x 5.1 cm)



**Stackable Mug**  
**CM12CL** Cloud      **CM12SH** Shadow  
 12 oz. (354.9 mL)  
 3 3/8" Dia. x 3 5/8" H (8.6 x 9.2 cm)





# THE CRAVE STORM COLLECTION



Storm  
(ST)

Our Crave Collection of break-resistant melamine dinnerware is now available in a bold, coordinating color: Storm. NSF-Certified and BPA-free, this collection is safe in terms of durability, design, and ability to be thoroughly sanitized.

Please add **ST** for Storm to the end of the item number to designate color choice when ordering.



**Coupe Plate**  
**CP10ST Storm**  
11 1/8" Dia. x 3/4" H (28.3 x 1.9 cm)



**Coupe Plate**  
**CP9ST Storm**  
9" Dia. x 1" H (22.9 x 2.5 cm)



**Coupe Plate**  
**CP7ST Storm**  
7 1/2" Dia. x 7/8" H (19.1 x 2.2 cm)



**Coupe Plate**  
**CP6ST Storm**  
6 1/2" Dia. x 3/4" H (16.5 x 1.9 cm)



**Rectangular Platter**  
**CP12ST Storm**  
12" L x 7 1/8" W x 1" H (30.5 x 18.1 x 2.5 cm)



**Bowl**  
**CBL20ST Storm**  
20 oz. (591.5 mL)  
9" Dia. x 1 1/2" H (22.9 x 3.8 cm)



**Soup/Salad Bowl**  
**CBL16ST Storm**  
16 oz. (473.2 mL)  
6" Dia. x 2" H (15.2 x 5.1 cm)



**Nappy Bowl**  
**CBL12ST Storm**  
12 oz. (354.9 mL)  
6" Dia. x 1 3/4" H (15.2 x 4.4 cm)



**Bouillon Cup**  
**CBC10ST Storm**  
10 oz. (295.7 mL)  
4 1/2" Dia. x 2 1/8" H (11.4 x 5.4 cm)



**Bouillon Cup**  
**CBC7ST Storm**  
7 oz. (207 mL)  
4" Dia. x 2" H (10.2 x 5.1 cm)



**Sauce Cup**  
**CSC4ST Storm**  
4 1/2 oz. (133.1 mL)  
3 1/4" Dia. x 2" H (8.3 x 5.1 cm)



**Stackable Mug**  
**CM12ST Storm**  
12 oz. (354.9 mL)  
3 3/8" Dia. x 3 3/8" H (8.6 x 9.2 cm)





## THE MARRA COLLECTION

Finally. A beautifully-crafted, globally-inspired, durable dinnerware line made with today's menus in mind. Textured just like handcrafted stoneware, it is hard to tell that these plates, bowls, and pots are actually made of durable and affordable melamine. Featuring key items, sizes and capacities, plus boasting NSF-approval, the Marra Collection is one to celebrate!



NEW



NEW

Top to bottom:  
MRP9TC  
MRP11TC





# THE MARRA COLLECTION

NEW

NSF

BPA FREE



Terra Cotta (TC)



Cloud (CL)

Please add **TC** for Terra Cotta or **CL** for Cloud to the end of the item number to designate color choice when ordering.



**Plate**  
**MRP11TC** Terra Cotta  
**MRP11CL** Cloud  
 11 1/8" Dia. x 1 1/8" H (28.3 x 2.9 cm)



**Plate**  
**MRP9TC** Terra Cotta  
**MRP9CL** Cloud  
 8 3/4" Dia. x 1 1/8" H (22.2 x 2.9 cm)



**Plate**  
**MRP7TC** Terra Cotta  
**MRP7CL** Cloud  
 7 1/2" Dia. x 1" H (19.1 x 2.5 cm)



**Bowl**  
**MRB22TC** Terra Cotta  
**MRB22CL** Cloud  
 22 oz. (650.6 mL)  
 6 3/8" Dia. x 2 1/2" H  
 (16.2 x 6.4 cm)



**Bowl**  
**MRB13TC** Terra Cotta  
**MRB13CL** Cloud  
 13 oz. (384.5 mL)  
 5 1/2" Dia. x 2 1/8" H  
 (14 x 5.4 cm)



**Bowl**  
**MRB10TC** Terra Cotta  
**MRB10CL** Cloud  
 10 oz. (295.7 mL)  
 4 1/4" Dia. x 2 1/2" H  
 (10.8 x 6.4 cm)



**Bowl**  
**MRB6TC** Terra Cotta  
**MRB6CL** Cloud  
 6 oz. (177.4 mL)  
 3 5/8" Dia. x 2 1/8" H  
 (9.2 x 5.4 cm)



**Pot**  
**MRPT6TC** Terra Cotta  
**MRPT6CL** Cloud  
 6 oz. (177.4 mL)  
 3" Dia. x 3 1/8" H (7.6 x 7.9 cm)



**Pot**  
**MRPT4TC** Terra Cotta  
**MRPT4CL** Cloud  
 4 oz. (118.3 mL)  
 2 3/4" Dia. x 2 3/4" H (7 x 7 cm)



**Pot**  
**MRPT3TC** Terra Cotta  
**MRPT3CL** Cloud  
 3 oz. (88.7 mL)  
 3 1/4" Dia. x 1 3/4" H (8.3 x 4.4 cm)





## THE JANE COLLECTION

Dinnerware has a new standard. The Jane Collection, our “basic” dinnerware line, is anything but ordinary. Simple and versatile by design, these plates, bowls, cups, platters and even sauce cups serve as ideal backdrops for all types of menu items. From low-key lunches to gastronomically-inspired dinners, the possibilities are practically endless.

We chose to craft the Jane Collection from melamine for two reasons: First, it's exceptionally resilient to the bumps, bangs and bounces that find their way into every kitchen. This dinnerware is in it for the long haul. Second, melamine is dishwasher-safe. No matter how you're inspired to fill these blank canvases, cleaning and reusing them is a cinch.





# THE JANE COLLECTION



**Wide Rim Plate**  
DPW10WH White  
10 ½" Dia. x ¾" H (26.7 x 1.9 cm)



**Wide Rim Plate**  
DPW9WH White  
9" Dia. x ¾" H (22.9 x 1.9 cm)



**Wide Rim Plate**  
DPW7WH White  
7 ½" Dia. x ¾" H (19.1 x 1.6 cm)



**Wide Rim B&B Plate**  
DPW6WH White  
6 ½" Dia. x ⅝" H (16.5 x 1.6 cm)



**Narrow Rim Plate**  
DPN10WH White  
10 ½" Dia. x ¾" H (26.7 x 1.9 cm)



**Narrow Rim Plate**  
DPN9WH White  
9" Dia. x ¾" H (22.9 x 1.9 cm)



**Narrow Rim Plate**  
DPN7WH White  
7 ½" Dia. x ⅝" H (19.1 x 1.6 cm)



**Narrow Rim B&B Plate**  
DPN6WH White  
6 ½" Dia. x ⅝" H (16.5 x 1.6 cm)



**Saucer**  
DS5WH White  
5 ½" Dia. x ⅝" H (14 x 1.6 cm)



**Oval Platter**  
DPL12WH White  
12" L x 9" W x 7/8" H (30.5 x 22.9 x 2.2 cm)



**Oval Platter**  
DPL9WH White  
9 ¾" L x 7 ¼" W x ½" H (24.8 x 18.4 x 1.3 cm)



**Stackable Mug**  
DM10WH White  
10 oz. (295.7 mL)  
3" Dia. x 3 ⅝" H (7.6 x 9.2 cm)



**Wide Rim Bowl**  
**DBW16WH** White  
 16 oz. (473.2 mL)  
 9 1/4" Dia. x 1 1/4" H (23.5 x 3.2 cm)



**Narrow Rim Bowl**  
**DBN32WH** White  
 32 oz. (946.4 mL)  
 8 1/2" Dia. x 2 3/8" H (21.6 x 6 cm)



**Narrow Rim Bowl**  
**DBN24WH** White  
 24 oz. (709.8 mL)  
 7 3/4" Dia. x 2 1/8" H (19.7 x 5.4 cm)



**Narrow Rim Bowl**  
**DBN16WH** White  
 16 oz. (473.2 mL)  
 7 1/4" Dia. x 1 7/8" H (18.4 x 4.8 cm)



**Bowl**  
**DB12WH** White  
 12 oz. (354.9 mL)  
 6 5/8" Dia. x 1 1/2" H (16.8 x 3.8 cm)



**Bowl**  
**DB8WH** White  
 8 oz. (236.6 mL)  
 6" Dia. x 1 3/8" H (15.2 x 3.5 cm)



**Fruit Bowl**  
**DB5WH** White  
 5 oz. (147.9 mL)  
 5" Dia. x 1 3/8" H (12.7 x 3.5 cm)



**Bouillon Cup**  
**DB10WH** White  
 10 oz. (295.7 mL)  
 4 1/2" Dia. x 2 1/4" H (11.4 x 5.7 cm)



**Bouillon Cup**  
**DB7WH** White  
 7 oz. (207 mL)  
 4" Dia. x 2 1/8" H (10.2 x 5.4 cm)



**Sauce Cup**  
**MSC8** White  
 8 oz. (236.6 mL)  
 3 5/8" Dia. x 2 1/8" H (9.2 x 5.4 cm)



**Sauce Cup**  
**DSC3WH** White  
 2 3/4 oz. (81.3 mL)  
 3 1/2" Dia. x 1" H (8.9 x 2.5 cm)



**Sauce Cup**  
**DSC1WH** White  
 1 oz. (29.6 mL)  
 2 3/4" Dia. x 7/8" H (7 x 2.2 cm)





PAIRS WELL WITH THE JANE COLLECTION

# THE JANE CASUAL COLLECTION



LINEN  
(LN)



DENIM  
(DN)

The Jane Casual Collection pairs the simple styling of the Jane Collection with fun, friendly finishes inspired by linen and denim. Crafted from durable melamine, these plates, bowls and serving platters let you turn any meal into comfort food.

Please add **LN** for Linen or **DN** for Denim to the end of the item number to designate color choice when ordering.



**Narrow Rim Plate**  
**DPN10LN** Linen      **DPN10DN** Denim  
 10 1/2" Dia. x 3/4" H  
 (26.7 x 1.9 cm)



**Narrow Rim Plate**  
**DPN9LN** Linen      **DPN9DN** Denim  
 9" Dia. x 3/4" H  
 (22.9 x 1.9 cm)



**Narrow Rim Bowl**  
**DBN16LN** Linen      **DBN16DN** Denim  
 16 oz. (473.2 mL)  
 7 1/4" Dia. x 1 7/8" H (18.4 x 4.8 cm)



**Bouillon Cup**  
**DB10LN** Linen      **DB10DN** Denim  
 10 oz. (295.7 mL)  
 4 1/2" Dia. 2 1/4" H (11.4 x 5.7 cm)



**Oval Platter**  
**DPL12LN** Linen      **DPL12DN** Denim  
 12" L x 9" W x 7/8" H  
 (30.5 x 22.9 x 2.2 cm)





## THE ANI COLLECTION

A marriage of economical and modish, the Ani Collection is the perfect way to give a subtle boost to your tabletop. Its cool, crisp design provides an ideal, affordable base for any tablescape.

Made of durable, NSF-approved melamine and available in all popular shapes and sizes, the Ani Collection provides a complete tabletop solution for anyone from small independent restaurants to high-volume dining halls.



NEW



NEW





**NEW**

AB12WH

AB10WH

ARP6WH

AB30WH

Top to bottom:  
ARP7WH  
ARP10WH



**NEW**

Top to bottom:  
ARP7WH  
ARP9WH  
ARP10WH

AP12WH

ARP6WH



**NEW**

AB16WH

AB30WH

AB12WH

AB10WH



**Coupe Plate**  
**ARP10WH** White  
 10 1/2" Dia. x 1" H  
 (26.7 x 2.5 cm)



**Coupe Plate**  
**ARP9WH** White  
 8 7/8" Dia. x 7/8" H  
 (22.5 x 2.2 cm)



**Coupe Plate**  
**ARP7WH** White  
 7 1/2" Dia. x 3/4" H  
 (19.1 x 1.9 cm)



**Coupe Plate**  
**ARP6WH** White  
 6 1/4" Dia. x 3/4" H  
 (15.9 x 1.9 cm)



**Rectangular Platter**  
**AP12WH** White  
 12" L x 7" W x 7/8" H  
 (30.5 x 17.8 x 2.2 cm)



**Bowl**  
**AB30WH** White  
 30 oz. (887.2 mL)  
 9" Dia. x 1 1/4" H  
 (22.9 x 3.2 cm)



**Bowl**  
**AB16WH** White  
 16 oz. (473.2 mL)  
 5" Dia. x 2 1/4" H  
 (12.7 x 5.7 cm)



**Bowl**  
**AB12WH** White  
 12 oz. (354.9 mL)  
 4 1/2" Dia. x 2" H  
 (11.4 x 5.1 cm)



**Bowl**  
**AB10WH** White  
 10 oz. (295.7 mL)  
 4" Dia. x 2 1/8" H  
 (10.2 x 5.4 cm)





## THE BLEND COLLECTION

Bento-inspired pieces and subtle colors intermingle together in a beautiful dinnerware puzzle of fun. The Blend Collection: Deconstructing today's love of compartments into a versatile array of presentation options. Each item is designed to be pieced together (like a puzzle) for an endless number of menu solutions. Use the deep-sided bowls for anything from soups to salads to sauces while the plates offer a home for sandwiches, snacks, and sides. Plus, each plate mindfully doubles as a lid for each bowl thus offering a covered option to keep food fresh. These functional pieces artfully blend together in a subtle neutral canvas ready for creative and colorful food plating.









# THE BLEND COLLECTION



**Plate**  
**BPR128CR** Cream  
 12 ¼" L x 8 ¼" W x ¾" H  
 (31.1 x 21 x 1.9 cm)



**Plate/Lid**  
**BPS8CR** Cream  
 7 ⅞" Sq. x ⅝" H  
 (20 x 1.6 cm)



**Bowl**  
**BBS44CR** Cream  
 44 oz. (1.3 L)  
 7 ⅞" Sq. x 2" H  
 (20 x 5.1 cm)



**Plate/Lid**  
**BPR84BI** Biscuit  
 7 ⅞" L x 4" W x ⅝" H  
 (20 x 10.2 x 1.6 cm)



**Bowl**  
**BBR20BI** Biscuit  
 20 oz. (591.5 mL)  
 7 ⅞" L x 4" W x 2" H  
 (20 x 10.2 x 5.1 cm)



**Plate/Lid**  
**BPS4CO** Coffee  
 4" Sq. x ⅝" H  
 (10.2 x 1.6 cm)



**Bowl**  
**BBS9CO** Coffee  
 9 oz. (266.2 mL)  
 4" Sq. x 2" H  
 (10.2 x 5.1 cm)



**Plate/Lid**  
**BPR42CO** Coffee  
 4" L x 2" W x ⅝" H  
 (10.2 x 5.1 x 1.6 cm)



**Bowl**  
**BBR4CO** Coffee  
 4 oz. (118.3 mL)  
 4" L x 2" W x 2" H  
 (10.2 x 5.1 x 5.1 cm)



RESILIENT MELAMINE MEANS THE ISABELLA COLLECTION IMPRESSES IN AL FRESCO SETTINGS TOO



BLUP5

BLUP14

From smallest  
to largest:  
BLUP6  
BLUP8  
BLUP11



# THE ISABELLA COLLECTION



Inspired by classic china, these timelessly nostalgic pieces feature beautiful floral designs that could pass as individually made. Whether you use them to serve entrées, hors d'oeuvres or desserts, your customers just might be transported to a Florentine patio when this collection reaches the table. Because the Isabella Collection is crafted from BPA-free, NSF-approved melamine, you can create elegant presentations day after day and night after night without concerns of safety or durability.



**Plate**  
**BLUP11**  
11" Dia. x 1" H  
(27.9 x 2.5 cm)



**Scalloped Plate**  
**BLUP8**  
8 ¾" Dia. x 1" H  
(22.2 x 2.5 cm)



**Plate**  
**BLUP6**  
6 ½" Dia. x ⅝" H  
(16.5 x 1.6 cm)



**Coupe Bowl**  
**BLUP5**  
6 oz. (177.4 mL)  
5" Dia. x 1" H  
(12.7 x 2.5 cm)



**Rectangular Platter**  
**BLUP14**  
14" L x 5 ⅝" W x 1 ¼" H  
(35.6 x 14.3 x 3.2 cm)





## THE DEL MAR COLLECTION BPA FREE

Poolside food service presents a unique set of challenges, and the Del Mar Collection is designed to meet all of them. Crafted from lightweight ABS plastic (a BPA-free, dishwasher-safe material), these stackable serving boxes can be used as both delivery trays and dinnerware. With stylish water-inspired details and modular design, they're the ideal way to present light fare indoors and out. Just remember to wait 30 minutes before going back in.

### Rectangular Serving Bowls and Lids

#### Gray

**BL11G** Lid/Platter  
11  $\frac{3}{8}$ " L x 8  $\frac{3}{8}$ " W x 1  $\frac{1}{8}$ " H  
(28.9 x 21.3 x 2.9 cm)

**B11G** Bowl  
96 oz. (2.8 L)  
11" L x 7  $\frac{7}{8}$ " W x 3" H  
(28 x 20 x 7.6 cm)

**BL14G** Lid/Platter  
14  $\frac{1}{4}$ " L x 10  $\frac{1}{2}$ " W x 1  $\frac{1}{8}$ " H  
(36.2 x 26.7 x 2.9 cm)

**B14G** Bowl  
156 oz. (4.6 L)  
13  $\frac{7}{8}$ " L x 10" W x 3" H  
(35.2 x 25.4 x 7.6 cm)

#### White

**BL11W** Lid/Platter  
11  $\frac{3}{8}$ " L x 8  $\frac{3}{8}$ " W x 1  $\frac{1}{8}$ " H  
(28.9 x 21.3 x 2.9 cm)

**B11W** Bowl  
96 oz. (2.8 L)  
11" L x 7  $\frac{7}{8}$ " W x 3" H  
(28 x 20 x 7.6 cm)

**BL14W** Lid/Platter  
14  $\frac{1}{4}$ " L x 10  $\frac{1}{2}$ " W x 1  $\frac{1}{8}$ " H  
(36.2 x 26.7 x 2.9 cm)

**B14W** Bowl  
156 oz. (4.6 L)  
13  $\frac{7}{8}$ " L x 10" W x 3" H  
(35.2 x 25.4 x 7.6 cm)

### Rectangular Serving Bowl Inserts

**B114W**  $\frac{1}{4}$ -Size Insert for B11G and B11W  
16 oz. (473.2 mL)  
5  $\frac{1}{4}$ " L x 3  $\frac{3}{4}$ " W x 2  $\frac{5}{8}$ " H  
(13.3 x 9.5 x 6.7 cm)

**B144W**  $\frac{1}{4}$ -Size Insert for B14G and B14W  
30 oz. (887.2 mL)  
6  $\frac{3}{4}$ " L x 4  $\frac{7}{8}$ " W x 2  $\frac{5}{8}$ " H  
(17.1 x 12.4 x 6.7 cm)

**B112W**  $\frac{1}{2}$ -Size Insert for B11G and B11W  
38 oz. (1.1 L)  
7  $\frac{5}{8}$ " L x 5  $\frac{1}{4}$ " W x 2  $\frac{5}{8}$ " H  
(19.4 x 13.3 x 6.7 cm)

**B142W**  $\frac{1}{2}$ -Size Insert for B14G and B14W  
66 oz. (2 L)  
9  $\frac{3}{4}$ " L x 6  $\frac{3}{4}$ " W x 2  $\frac{5}{8}$ " H  
(24.8 x 17.1 x 6.7 cm)



## Round Serving Bowls and Lids

### Gray

**BL10G** Lid/Plate  
10 3/8" Dia. x 1 1/8" H  
(26.4 x 2.9 cm)

**B10G** Bowl  
80 oz. (2.4 L)  
10" Dia. x 3" H  
(25.4 x 7.6 cm)

**BL12G** Lid/Plate  
12 3/8" Dia. x 1 1/8" H  
(31.4 x 2.9 cm)

**B12G** Bowl  
118 oz. (3.5 L)  
12" Dia. x 3" H  
(30.5 x 7.6 cm)

### White

**BL10W** Lid/Plate  
10 3/8" Dia. x 1 1/8" H  
(26.4 x 2.9 cm)

**B10W** Bowl  
80 oz. (2.4 L)  
10" Dia. x 3" H  
(25.4 x 7.6 cm)

**BL12W** Lid/Plate  
12 3/8" Dia. x 1 1/8" H  
(31.4 x 2.9 cm)

**B12W** Bowl  
118 oz. (3.5 L)  
12" Dia. x 3" H  
(30.5 x 7.6 cm)

### Round Serving Bowl Inserts

**B104W** 1/4-Size Insert for B10G and B10W  
15 oz. (443.6 mL)  
4 3/4" L x 4 3/4" W x 2 5/8" H  
(12.1 x 12.1 x 6.7 cm)

**B124W** 1/4-Size Insert for B12G and B12W  
24 oz. (709.8 mL)  
5 3/4" L x 5 3/4" W x 2 5/8" H  
(14.6 x 14.6 x 6.7 cm)

**B102W** 1/2-Size Insert for B10G and B10W  
34 oz. (1 L)  
9 1/2" L x 4 3/4" W x 2 5/8" H  
(24.1 x 12.1 x 6.7 cm)

**B122W** 1/2-Size Insert for B12G and B12W  
52 oz. (1.5 L)  
11 1/2" L x 5 3/4" W x 2 5/8" H  
(29.2 x 14.6 x 6.7 cm)







BENTO BOXES ARE CONVENIENTLY STACKABLE

## Naturals Collection

### Bento Boxes BPA FREE

Meal delivery has received a beautiful makeover with the Naturals Collection Bento Box. Sleek and stylish with a hint of marble, each box is durable and stackable with matching lids. Choose from boxes with or without compartments for added versatility.

- BB5WH** 5-Compartment White Bento Box  
10 7/8" L x 8 1/4" W x 2" H  
(27.6 x 21 x 5.1 cm)
- BB1WH** White Bento Box  
10 7/8" L x 8 1/4" W x 2 3/4" H  
(27.6 x 21 x 7 cm)
- BBLWH** White Lid/Tray  
10 7/8" L x 8 1/4" W x 3/4" H  
(27.6 x 21 x 1.9 cm)
- BBLWM** White Marble Lid/Tray  
10 7/8" L x 8 1/4" W x 3/4" H  
(27.6 x 21 x 1.9 cm)

### Shallow Round Melamine Bowls BPA FREE

Whether you serve poke bowls, açai bowls or regular old mac & cheese, these beautiful white pieces will present your creations with style.

- MELR5** 8 oz. (236.6 mL)  
5 1/4" Dia. x 1" H (13.3 x 2.5 cm)
- MELR6** 14 oz. (414 mL)  
6 5/8" Dia. x 1 3/8" H (16.8 x 3.5 cm)
- MELR8** 28 oz. (828 mL)  
8" Dia. x 1 3/4" H (20.3 x 4.4 cm)
- MELR9** 46 oz. (1.4 L)  
9 1/2" Dia. x 2 1/8" H (24.1 x 5.4 cm)
- MELR11** 86 oz. (2.5 L)  
11 1/4" Dia. x 2 3/8" H (28.6 x 6 cm)



### Melamine Paper Plates BPA FREE

Much more durable than its cardboard counterparts, pure white melamine pieces are whimsically designed like paper plates, but dress up events with their look and feel.

- MP6** 5 7/8" Dia. x 5/8" H  
(14.9 x 1.6 cm)
- MP7** 7 3/8" Dia. x 5/8" H  
(18.7 x 1.6 cm)
- MP9** 8 7/8" Dia. x 5/8" H  
(22.5 x 1.6 cm)
- MP11** 10 7/8" Dia. x 3/4" H  
(27.6 x 1.9 cm)





# Tabletop Accessories









Shown with BNCB84 coffee caddy and PCR25 creamer

HOT

HTSH5

HTSH3

HTSH1

### Taco Holders HOT

In brushed stainless steel, these holders are a fun, modern way to serve anything from tacos to hot dogs to cannoli.

#### Full-Size

- TSH1** 1 or 2 Compartments  
5" L x 4" W x 2" H  
(12.7 x 10.2 x 5.1 cm)
- TSH3** 2 or 3 Compartments  
8" L x 4" W x 2" H  
(20.3 x 10.2 x 5.1 cm)
- TSH5** 4 or 5 Compartments  
13 ¼" L x 4" W x 2" H  
(33.7 x 10.2 x 5.1 cm)

#### Half-Size

- HTSH1** 1 or 2 Compartments  
5" L x 2" W x 2" H  
(12.7 x 5.1 x 5.1 cm)
- HTSH3** 2 or 3 Compartments  
8" L x 2" W x 2" H  
(20.3 x 5.1 x 5.1 cm)
- HTSH5** 4 or 5 Compartments  
13 ¼" L x 2" W x 2" H  
(33.7 x 5.1 x 5.1 cm)

#### Mini

- MTSH1** 1 or 2 Compartments  
2" L x 2" W x 1" H  
(5.1 x 5.1 x 2.5 cm)
- MTSH3** 2 or 3 Compartments  
4" L x 2" W x 1" H  
(10.2 x 5.1 x 2.5 cm)
- MTSH5** 4 or 5 Compartments  
7" L x 2" W x 1" H  
(17.8 x 5.1 x 2.5 cm)



HOT

MTSH1

MTSH3

MTSH5





THMW5

THMW1

THMW3 shown with  
FSR11 serving peel and  
MB3 sauce cup



THMB5

THMB1

THMB3

## Faux Slate Melamine

### Taco Holders

These must-have pieces pair two trends: the look of slate and the love of tacos. Each of these reversible designs is crafted from dishwasher-safe melamine.

#### White

**THMW1** 1 or 2 Compartments  
5" L x 3" W x 2" H  
(12.7 x 7.6 x 5.1 cm)

**THMW3** 2 or 3 Compartments  
8" L x 3" W x 2" H  
(20.3 x 7.6 x 5.1 cm)

**THMW5** 4 or 5 Compartments  
13 ¼" L x 3" W x 2" H  
(33.7 x 7.6 x 5.1 cm)

#### Black

**THMB1** 1 or 2 Compartments  
5" L x 3" W x 2" H  
(12.7 x 7.6 x 5.1 cm)

**THMB3** 2 or 3 Compartments  
8" L x 3" W x 2" H  
(20.3 x 7.6 x 5.1 cm)

**THMB5** 4 or 5 Compartments  
13 ¼" L x 3" W x 2" H  
(33.7 x 7.6 x 5.1 cm)

#### Terra Cotta

**THMT1** 1 or 2 Compartments  
5" L x 3" W x 2" H  
(12.7 x 7.6 x 5.1 cm)

**THMT3** 2 or 3 Compartments  
8" L x 3" W x 2" H  
(20.3 x 7.6 x 5.1 cm)

**THMT5** 4 or 5 Compartments  
13 ¼" L x 3" W x 2" H  
(33.7 x 7.6 x 5.1 cm)

## Acacia Wood Taco Holder

This is one of those designs that will make your customers say, "Why haven't I seen this before?" This beautiful, surprisingly simple piece holds up to eight tacos and delivers instant delight.

**THW8** 8-Compartment  
16 ½" L x 2 ¾" W x 2 ¾" H  
(41 x 7 x 6 cm)







THESE TINY POTS RANGE  
FROM JUST 4 OZ. TO 24 OZ.

MPL24

MPL14

MPL8

MPL4



MPS22 shown on  
TRV085 silicone trivet  
with HAMSC sauce cup  
and SSSK knife

MPS14

### Mini Pots with Lids

There's nothing miniature about the charm and nostalgia created by these stainless steel replicas.

**MPL4** 4 oz. (118.3 mL)  
2 5/8" Dia. x 1 3/4" H  
3 1/4" L with Handles  
(6.7 x 4.4, 8.3 cm)

**MPL8** 8 oz. (236.6 mL)  
3 1/2" Dia. x 2 1/2" H  
4" L with Handles  
(8.9 x 6.3, 10.2 cm)

**MPL14** 14 oz. (414 mL)  
4 1/4" Dia. x 3" H  
5 1/2" L with Handles  
(10.8 x 7.6, 14 cm)

**MPL24** 24 oz. (709.8 mL)  
5" Dia. x 3 1/4" H  
6 1/4" L with Handles  
(12.7 x 8.3, 15.9 cm)

### Oval Hammered Mini Skillets

These stainless steel skillets are individually hammered for oven-to-table elegance.

**MPS14** 14 oz. (414 mL)  
6 3/4" L x 5 1/2" W x 1 1/2" H  
11 3/4" L with Handle  
(17.1 x 14 x 3.8, 29.8 cm)

**MPS22** 22 oz. (650.6 mL)  
8" L x 6 1/4" W x 1 3/8" H  
12 5/8" L with Handle  
(20.3 x 15.9 x 3.5, 32.1 cm)

## Mini Cookware

Creative appetizers and desserts call for creative stainless steel serving vessels.

### Pots

- SHSP21** 5 oz. (147.9 mL)  
2 ¾" Dia. x 1 ¾" H  
5 ½" L with Handle  
(7.0 x 4.4, 14 cm)
- SHSP32** 12 oz. (354.9 mL)  
3 ½" Dia. x 2 ½" H  
6 ¼" L with Handle  
(8.9 x 6.3, 15.9 cm)
- SHSP53** 27 oz. (798.5 mL)  
4 ¾" Dia. x 3" H  
9 ¼" L with Handle  
(12.1 x 7.6, 23.5 cm)

### Fry Pans

- SHSP20** 2 ½ oz. (73.9 mL)  
2 ¾" Dia. x 1" H  
5 ½" L with Handle  
(7 x 2.5, 14 cm)
- SHSP40** 7 ½ oz. (221.8 mL)  
4" Dia. x 1 ¼" H  
7 ½" L with Handle  
(10.2 x 3.2, 19.1 cm)
- SHSP41** 13 oz. (384.5 mL)  
4 ¾" Dia. x 1 ½" H  
9 ⅛" L with Handle  
(12.1 x 3.8, 23.2 cm)

## Mini Roasting Pans

A customer favorite, these petite stainless steel roasting pans deliver practicality and pretty presentation.

- MRPS45** 14 oz. (414 mL)  
4 ½" Sq. x 1 ¾" H  
6 ⅞" L with Handles  
(11.4 x 4.4, 15.6 cm)
- MRP53** 17 oz. (502.8 mL)  
5 ¾" L x 3 ¾" W x 1 ¾" H  
7 ¼" L with Handles  
(14.6 x 9.5 x 4.4, 18.4 cm)





Top to bottom:

- BSPP4
- BSPP6
- BSPP8
- BSPP9
- BSPP11



## Black Steel Paella Pans

Just like the real thing, these smaller versions of traditional paella pans are sure to be crowd pleasers. Made of black steel, these pans can withstand high heat either from the oven, broiler or induction burner. Perfect for oven-to-table entrees, individual portions or sides.

- BSPP4** 8 oz. (236.6 mL)  
4 7/8" Dia. x 1 1/8" H, 6" L with Handles  
(12.4 x 2.8, 15.2 cm)
- BSPP5** 13 oz. (384.5 mL)  
5 5/8" Dia. x 1 1/4" H, 6 3/4" L with Handles  
(14.3 x 3.2, 17.1 cm)
- BSPP6** 18 oz. (532.3 mL)  
6 1/2" Dia. x 1 3/8" H, 7 5/8" L with Handles  
(16.5 x 3.5, 19.4 cm)
- BSPP8** 30 oz. (887.2 mL)  
8" Dia. x 1 1/2" H, 9 1/2" L with Handles  
(20.3 x 3.8, 24.1 cm)
- BSPP9** 52 oz. (1.5 L)  
9 1/2" Dia. x 1 7/8" H, 11" L with Handles  
(24.1 x 4.8, 27.9 cm)
- BSPP11** 82 oz. (2.4 L)  
11" Dia. x 2" H, 12 1/4" L with Handles  
(27.9 x 5.1, 31.1 cm)
- BSPP12** 126 oz. (3.7 L)  
12 5/8" Dia. x 2 1/4" H, 14" L with Handles  
(32 x 5.7, 35.6 cm)

Shown with HM11CMF fork and HM8TNG tongs



## Stainless Steel Balti Dishes

It's easy to see your own creations making an impact with the help of the beautiful mirror finish on these pieces. Stylish handles make transport easy.

- BD35** 10 oz. (295.7 mL)  
4 1/4" Dia. x 2 3/4" H, 4 3/4" W with Handles  
(10.8 x 7, 12.1 cm)
- BD45** 16 oz. (473.2 mL)  
5 1/8" Dia. x 2 1/2" H, 6 1/2" W with Handles  
(13 x 6.4, 16.5 cm)
- BD55** 18 oz. (532.3 mL)  
5 3/4" Dia. x 2 3/4" H, 7 1/4" W with Handles  
(14.6 x 7, 18.4 cm)
- BD65** 32 oz. (946.4 mL)  
6 5/8" Dia. x 3 1/4" H, 8" W with Handles  
(16.9 x 8.3, 20.3 cm)
- BD72** 40 oz. (1.2 L)  
7" Dia. x 4" H, 8 7/8" W with Handles  
(17.8 x 10.2, 22.5 cm)
- BD87** 62 oz. (1.8 L)  
8 1/8" Dia. x 4 1/4" H, 9 7/8" W with Handles  
(20.6 x 10.8, 25.1 cm)
- BD93** 105 oz. (3.1 L)  
9 3/8" Dia. x 4 3/4" H, 11" W with Handles  
(23.8 x 12.1, 27.9 cm)





### Sizzle Platters

Mirror-finished aluminum allows for maximum sizzle while moving from oven to table.

**PLA710** Sizzle Platter  
10 ½" L x 7" W  
(26.7 x 17.8 cm)

**PLA810** Sizzle Platter  
11 ½" L x 8" W  
(29.2 x 20.3 cm)

**PLA912** Sizzle Platter  
12 ½" L x 9" W  
(31.8 x 22.9 cm)

### Stainless Steel Mussel Server

Elevate mussels and fish stews with this nautically elegant server.

**SSMS9** 64 oz. (1.9 L) Server with Lid  
7" Dia. x 6 ¾" H, 9" W with Handles  
(17.8 x 17.1, 22.9 cm)



Shown with HMRT814 hammered tray

LID IS PERFECT FOR SHELL DISPOSAL

SSMS9





## CAST IRON

Take our pre-seasoned cast iron pots, pans and casseroles out of the oven and onto the table. Larger sizes available on pg. 182.

### Fry Pans and Casseroles

- CIPRT5336** 9 ½ oz. (280.9 mL)  
5 ¾" L x 3 ⅝" W x 1 ½" H, 7" L with Handles  
(13.7 x 9.2 x 4.1, 17.8 cm)
- CIPS61** 9 ½ oz. (280.9 mL)  
5 ¾" Sq. x ⅞" H, 7 ⅞" L with Handles  
(14.6 x 2.2, 18.1 cm)
- CIS41** 3 ½ oz. (103.5 mL)  
3 ⅞" Dia. x 1" H, 6 ⅞" L with Handle  
(9.8 x 2.5, 17.5 cm)
- CIS51** 8 ½ oz. (251.4 mL)  
5" Dia. x 1 ½" H, 8 ¼" L with Handle  
(12.7 x 3.8, 21 cm)
- CIS61** 15 ½ oz. (458.4 mL)  
6 ¼" Dia. x 1 ¼" H, 10" L with Handle  
(15.9 x 3.2, 25.4 cm)

### Round Casseroles and Pots

- CIPR5125** 8 ½ oz. (251.4 mL)  
5" Dia. x 1 ¼" H, 6 ½" L with Handles  
(12.7 x 3.2, 16.5 cm)
- CIPR6250** 19 oz. (561.9 mL)  
6 ¼" Dia. x 1 ½" H, 8 ¾" L with Handles  
(15.9 x 3.8, 22.2 cm)
- CIPR7251** 27 oz. (798.5 mL)  
7 ¼" Dia. x 1 ¾" H, 9 ⅝" L with Handles  
(18.4 x 4.4, 24.5 cm)
- CIPR42** 9 oz. (266.2 mL)  
4" Dia. x 2" H, 5 ⅝" L with Handles, 3" H with Knob  
(12.7 x 5.1, 14.3, 6 cm)
- CIPR5500** 19 oz. (561.9 mL)  
5" Dia. x 2 ¼" H, 6 ½" L with Handles, 3 ¾" H with Knob  
(12.7 x 5.7, 16.5, 9.5 cm)
- CIPR5526** 27 oz. (798.5 mL)  
5 ½" Dia. x 2 ⅝" H, 7 ⅝" L with Handles, 4" H with Knob  
(14 x 6.6, 19.4, 10.2 cm)

### Oval Casseroles and Pots

- CIPOV856** 27 oz. (798.5 mL)  
8 ½" L x 6" W x 1 ¾" H, 10 ⅞" L with Handles  
(21.6 x 15.2 x 4.5, 27.6 cm)
- CIPOV9567** 36 ½ oz. (1.1 L)  
9 ½" L x 6 ⅜" W x 2" H, 12" L with Handles  
(24.1 x 16.2 x 5.1, 30.5 cm)
- CIPOV63** 11 ½ oz. (340.1 mL)  
5" L x 2 ⅝" W x 2" H, 6 ½" L with Handles, 3" H with Knob  
(12.7 x 6.7 x 5, 16.5, 7.6 cm)
- CIPOV6040** 17 ½ oz. (517.5 mL)  
6" L x 4" W x 2 ½" H, 7 ½" L with Handles, 3 ⅞" H with Knob  
(15.2 x 10.2 x 6.4, 19.1, 9.8 cm)
- CIPOV745** 23 ½ oz. (695 mL)  
7" L x 4 ½" W x 2 ¼" H, 8 ½" L with Handles, 4" H with Knob  
(17.8 x 11.4 x 5.7, 21.6, 10.2 cm)

### Mini Griddle

- CIG85** 8 ¼" L x 5 ¾" W x ¾" H, 9 ½" L with Handles  
(21 x 14.6 x 1.9, 24.1 cm)



### Mini Cast Iron Fondue Pot and Stand

- CIFD** Cast Iron Pot, 12 ½ oz. (369.7 mL)  
4 ⅝" Dia. x 1 ¾" H, 7 ⅞" L with Handle  
(11.7 x 4.5, 18.1 cm)
- CIFDR** Stainless Steel Stand  
5" Dia. x 3 ¼" H  
(12.7 x 8.3 cm) (Tea lights not included)



### Silicone Trivets

- TRVR5** Round  
5" Dia. x ¼" H  
(12.7 x 0.6 cm)
- TRVR675** Round  
6 ¾" Dia. x ¼" H  
(17.1 x 0.6 cm)
- TRV053** Oval  
5 ½" L x 3 ¾" W x ¼" H  
(14 x 9.5 x 0.6 cm)
- TRV085** Oval  
8 ¾" L x 5 ⅞" W x ¼" H  
(22.2 x 14.9 x 0.6 cm)
- TRVS6** Square  
6" Sq. x ¼" H  
(15.2 x 0.6 cm) (not shown)
- TRV875** Rectangular  
8 ¾" L x 6 ½" W x ¼" H  
(22.2 x 16.5 x 0.6 cm) (not shown)



### Steak Knives

- KNF2** Black Plastic Handle, Rounded Tip  
5" L Blade, 9" L Overall  
(12.7 x 22.9 cm)
- KNF7** Pom, Full Tang, Pointed Tip  
4 ½" L Blade, 8 ¾" L Overall  
(11.4 x 22.2 cm)
- KNF6** Jumbo Black Plastic, Rounded Tip  
5" L Blade, 10" L Overall  
(12.7 x 25.4 cm)
- KNF3** Hardwood Handle, Rounded Tip  
5 ⅞" L Blade, 10" L Overall  
(13 x 25.4 cm)
- KNF4** Pakkawood Handle, Pointed Tip  
4 ¾" L Blade, 8" L Overall  
(11.1 x 20.3 cm)
- KNF8** Jumbo Black Pom, Full Tang, Rounded Tip  
5" L Blade, 10" L Overall  
(12.7 x 25.4 cm)
- SSKNF9** Satin Finish  
5" L Blade, 9" L Overall  
(12.7 x 22.9 cm)
- SSKNF8** Mirror Finish  
5" L Blade, 9" L Overall  
(12.7 x 22.9 cm)
- SSSK** Jumbo Black Pom, Full Tang  
5 ⅞" L Blade, 10 ¼" L Overall  
(13 x 26 cm)







### Melamine Cast Iron Pots

The rustic look of cast iron meets the lightweight of melamine in these serving dishes. They're easy to wash and even easier to carry. Not for oven or stove use.

#### Black

**MC61** Oval Casserole, 5 oz. (147.9 mL)  
 4 3/4" L x 3" W x 1 1/4" H  
 6" L with Handles  
 (12.1 x 7.6 x 3.2, 15.2 cm)

**MC41** Round Casserole, 6 oz. (177.4 mL)  
 4 3/8" Dia. x 1 1/4" H  
 6" L with Handles  
 (11.1 x 3.2, 15.2 cm)

**MFP41** Fry Pan, 6 oz. (177.4 mL)  
 4 3/8" Dia. x 1 1/4" H  
 6 1/4" L with Handle  
 (12.1 x 3.2, 15.9 cm)

**MCR72** Round Casserole, 39 oz. (1.2 L)  
 7 5/8" Dia. x 2 3/8" H  
 9 7/8" L with Handles  
 (19.4 x 6, 25.1 cm)

**MC81** Oval Casserole, 13 oz. (384.5 mL)  
 8 1/4" L x 5 1/2" W x 1 1/2" H  
 10 3/8" L with Handles  
 (21 x 14 x 3.4, 26.4 cm)

**MFP81** Fry Pan, 24 oz. (709.8 mL)  
 8 1/2" Dia. x 1 1/4" H  
 12" L with Handles  
 (21.6 x 3.2, 30.5 cm)

**MB93** Round Bowl, 82 oz. (2.4 L)  
 9 3/4" Dia. x 3 1/4" H  
 12 1/2" L with Handles  
 (24.8 x 8.3, 31.8 cm)



**White**

- MCW61** Oval Casserole, 5 oz. (147.9 mL)  
4 3/4" L x 3" W x 1 1/4" H  
6" L with Handles  
(12.1 x 7.6 x 3.2, 15.2 cm)
- MCW41** Round Casserole, 6 oz. (177.4 mL)  
4 3/8" Dia. x 1 1/4" H  
6" L with Handles  
(11.1 x 3.2, 15.2 cm)
- MFPW41** Fry Pan, 6 oz. (177.4 mL)  
4 3/8" Dia. x 1 1/4" H  
6 1/4" L with Handle  
(12.1 x 3.2, 15.9 cm)
- MCRW72** Round Casserole, 39 oz. (1.2 L)  
7 5/8" Dia. x 2 3/8" H  
9 7/8" L with Handles  
(19.4 x 6, 25.1 cm)
- MCW81** Oval Casserole, 13 oz. (384.5 mL)  
8 1/4" L x 5 1/2" W x 1 1/2" H  
10 3/8" L with Handles  
(21 x 14 x 3.4, 26.4 cm)
- MFPW81** Fry Pan, 24 oz. (709.8 mL)  
8 1/2" Dia. x 1 1/4" H  
12" L with Handle  
(21.6 x 3.2, 30.5 cm)
- MBW93** Round Bowl, 82 oz. (2.4 L)  
9 3/4" Dia. x 3 1/4" H  
12 1/2" L with Handles  
(24.8 x 8.3, 31.8 cm)







Shown with HAMSCB3 sauce cup



### Melamine Cast Iron Serving Peels

Serve up a little personality with your fast-casual meals and sides. These trendy serving peels take on the rustic appearance of cast iron, but are actually crafted of durable, dishwasher-safe melamine. Available in your choice of white or black. Not for oven or stove use.

#### Black

**MSP61** 6 7/8" L x 5 1/2" W x 1/2" H  
9 1/2" L with Handle  
(17.5 x 14 x 1.3, 24.1 cm)

**MSP91** 9 1/8" L x 7 3/8" W x 1/2" H  
12 5/8" L with Handle  
(23.2 x 18.7 x 1.3, 32.1 cm)

#### White

**MSPW61** 6 7/8" L x 5 1/2" W x 1/2" H  
9 1/2" L with Handle  
(17.5 x 14 x 1.3, 24.1 cm)

**MSPW91** 9 1/8" L x 7 3/8" W x 1/2" H  
12 5/8" L with Handle  
(23.2 x 18.7 x 1.3, 32.1 cm)



### Melamine Shovels NEW BPA FREE

Creatively serve appetizers, meals and sides with our shovel-shaped melamine platter. Offered in colors black (Midnight) and gray (Shadow), both sizes provide a textured surface and are perfect for indoor and outdoor use.

#### Shadow

**SP8SH** 8 ½" L x 6 ¼" W x 1 ⅝" H  
(21.6 x 15.9 x 5.1 cm)

**SP10SH** 10 ½" L x 7 ¾" W x 2" H  
(23.2 x 19.7 x 5.1 cm)

#### Midnight

**SP8MN** 8 ½" L x 6 ¼" W x 1 ⅝" H  
(21.6 x 15.9 x 5.1 cm)

**SP10MN** 10 ½" L x 7 ¾" W x 2" H  
(23.2 x 19.7 x 5.1 cm)







MSJ5 jars shown with BR15 multifunctional riser

## Melamine Square Jars BPA FREE

Our most popular glass square jars are available in durable melamine! Organize, serve and store in these simple and nestable white melamine jars. Use alone or with our condiment racks, even top with a PET lid to keep food covered.

- MSJ3** 10 oz. (295.7 mL)  
3" Sq. x 3" H (7.6 x 7.6 cm)
- MSJ4** 22 oz. (650.6 mL)  
4" Sq. x 4" H (10.2 x 10.2 cm)
- MSJ5** 44 oz. (1.3 L)  
4 7/8" Sq. x 5" H (12.4 x 12.7 cm)

### Pet Lids

- LGJ8** 3" Sq. x 3/8" H (7.6 x 1 cm)  
(not shown)
- LGJ24** 4" Sq. x 3/8" H (10.2 x 1 cm)
- LGJ40** 5" Sq. x 3/8" H (12.7 x 1 cm)  
(not shown)



MSJ4 shown with LGJ24 lid

MSJ5

MSJ3

## Terra Cotta Melamine Pots BPA FREE

Customers everywhere are intrigued by these cleverly designed pieces. These pots pair the look of earthenware with the durability you've come to expect from our melamine collection. Bring al fresco color to whatever you serve in them.

- MELPOT2** 3 1/2 oz. (103.5 mL)  
2 3/4" Dia. x 2 3/8" H (7 x 6 cm)
- MELPOT8** 8 oz. (236.6 mL)  
3 1/2" Dia. x 3 1/8" H (8.9 x 7.9 cm)
- MELPOT14** 16 oz. (473.2 mL)  
4 3/8" Dia. x 4" H (11.1 x 10.2 cm)
- MELPOT24** 28 oz. (828.1 mL)  
5 1/4" Dia. x 4 3/4" H (13.3 x 12.1 cm)



MELPOT24

MELPOT14

MELPOT2

MELPOT8



### Square Glass Jars

Our trendy geometric jars are great for front- and back-of-house. Feeling adventurous? Use them to serve drinks.

- GJ6** 6 oz. (177.4 mL)  
2 1/2" Sq. x 2 1/2" H (6.4 x 6.4 cm)
- GJ8** 8 oz. (236.6 mL)  
3" Sq. x 3" H (7.6 x 7.6 cm)
- GJ24** 24 oz. (709.8 mL)  
4" Sq. x 4" H (10.2 x 10.2 cm)
- GJ40** 40 oz. (1.2 L)  
4 3/4" Sq. x 4 7/8" H (12.1 x 12.4 cm)

### PET Lids

- LGJ6** GJ6 Lid, 2 5/8" Sq. x 3/8" H (6.7 x 1 cm)  
(not shown)
- LGJ8** GJ8 Lid, 3" Sq. x 3/8" H (7.6 x 1 cm)  
(not shown)
- LGJ24** GJ24 Lid, 4" Sq. x 3/8" H (10.2 x 1 cm)
- LGJ40** GJ40 Lid, 5" Sq. x 3/8" H (12.7 x 1 cm)  
(not shown)

### Round Glass Jars

These simple, versatile 4- and 6-oz. jars practically beg for imaginative uses.

- RGJ4** 4 oz. (118.3 mL)  
2" Dia. x 2 7/8" H (5.1 x 7.3 cm)
- RGJ6** 6 oz. (177.4 mL)  
2 5/8" Dia. x 3 1/8" H (6.7 x 7.9 cm)

### Plastic Cap

- LRGJ6** RGJ4 and RGJ6 Lid  
2 5/8" Dia. x 3/8" H (6.7 x 1 cm)







**LMJ1785**  
PET LIDS FIT OVER OPENING  
FOR PREP AND STORAGE

### Mason Jars

With the popularity of pickling and fermentation, it's the ideal time to serve food or drinks in these classic glass pieces.

- MJ85** 8 ½ oz. (251.4 mL)  
3" Dia. x 4" H (7.6 x 10.2 cm)
- MJ17** 17 oz. (502.8 mL)  
3" Dia. x 5 ⅝" H (7.6 x 13.7 cm)
- MJ16** 16 oz. (473.2 mL)  
4 ¼" Dia. x 3 ½" H (10.8 x 8.9 cm)
- MJ22** 22 oz. (650.6 mL)  
4 ¼" Dia. x 5" H (10.8 x 12.7 cm)

### PET Lids

- LMJ1785** MJ17 Lid and MJ85 Lid  
2 ⅞" Dia. x ⅜" H (7.3 x 1 cm)
- LMJ1622** MJ16 Lid and MJ22 Lid  
3 ⅞" Dia. x ⅜" H (9.8 x 1 cm)  
(not shown)



### Apothecary Jars

The full-size versions of our rustic apothecary jars are perfect for pickling and presentation alike.

- HMJ4** 16 oz. (473.2 mL)  
3 ½" Dia. (4 ½" Dia. with Hinges) x 4" H  
(8.9 (11.4) x 10.2 cm)
- HMJ5** 26 oz. (768.9 mL)  
3 ½" Dia. (4 ½" Dia. with Hinges) x 5 ½" H  
(8.9 (11.4) x 14 cm)
- HMJ6** 35 oz. (1 L)  
3 ½" Dia. (4 ¾" Dia. with Hinges) x 6 ½" H  
(8.9 (12.1) x 16.5 cm)

### Mini Apothecary Jars

Blending the trends of miniatures and jars, these rustic pieces are sure to please.

- HMMJ1** 1 ½ oz. (44.4 mL)  
1 ¾" Dia. (2 ½" Dia. with Hinges) x 2 ½" H  
(4.4 (6.4) x 6.4 cm)
- HMMJ2** 2 ½ oz. (73.9 mL)  
1 ¾" Dia. (2 ½" Dia. with Hinges) x 3 ½" H  
(4.4 (6.4) x 8.9 cm)
- HMMJ3** 3 ½ oz. (103.5 mL)  
2 ¼" Dia. (3 ¼" Dia. with Hinges) x 2 ¾" H  
(5.7 (8.3) x 7 cm)
- HMMJ4** 4 oz. (118.3 mL)  
1 ¾" Dia. (2 ½" Dia. with Hinges) x 3 ¼" H  
(4.4 (6.4) x 8.3 cm)
- HMMJ5** 5 oz. (147.9 mL)  
2 ¼" Dia. (3 ¼" Dia. with Hinges) x 3" H  
(5.7 (8.3) x 7.6 cm)



## Glass Zipper Bag

Your customers will reach for their phones when they see this memorable, social media-worthy glass container.

**GZB22** 22 oz. (650.6 mL)  
5" Dia. x 4 ¾" H (12.7 x 12 cm)

## Glass Milk Bottles

With a winsome combination of nostalgia and playfulness, these milk bottles will particularly please at brunches and catered events.

**GMB3** 3 oz. (88.7 mL)  
1 ¾" Dia. x 4" H (4.5 x 10.2 cm)

**GMB6** 6 oz. (177.4 mL)  
2" Dia. x 5" H (5.1 x 12.7 cm)

**GMB8** 8 oz. (233.6 mL)  
2 ¼" Dia. x 5 ½" H (5.7 x 14 cm)

**GMB16** 16 oz. (473.2 mL)  
2 ¾" Dia. x 6 ½" H (7 x 16.5 cm)

**GMB32** 32 oz. (946.4 mL)  
3 ¼" Dia. x 8 ¼" H (8.3 x 21 cm)

## PET Lids

**LGMB3** GMB3 Lid, 1 ½" Dia. x ¾" H (3.8 x 1 cm)

**LGMB68** GMB6 and GMB8 Lid  
1 ⅞" Dia. x ¾" H (4.8 x 1 cm)  
(not shown)

**LGMB16** GMB16 Lid, 2 ¼" Dia. x ¾" H (5.7 x 1 cm)  
(not shown)

## Plastic Caps

**CAP3** GMB3 Lid, 1 ½" Dia. x ¾" H (3.8 x 1 cm)

**CAP6** GMB6 Lid, 1 ¾" Dia. x ¾" H (4.4 x 1 cm)  
(not shown)

**CAP8** GMB8 Lid, 2" Dia. x ¾" H (5.1 x 1 cm)  
(not shown)

**CAP16** GMB16 and GMB32 Lid, 2 ¾" Dia. x ¾" H  
(6 x 1 cm)  
(not shown)



GZB22



GMB32

GMB16

GMB8

GMB6

GMB3

LGMB3

CAP3

CHOOSE FROM TWO  
TYPES OF PLASTIC LIDS







## Stainless Steel Fry Cups HOT

Among our most popular items, these pieces come in different shapes and finishes to make your frites pop.

### Straight-Sided

**FFC337** Satin Finish  
14 oz. (414 mL)  
3 3/8" Dia. x 3 3/8" H (8.6 x 8.6 cm)

**FFHM37** Hammered Finish  
14 oz. (414 mL)  
3 3/8" Dia. x 3 3/8" H (8.6 x 8.6 cm)

### Angled

**FFCS45** Satin Finish  
12 oz. (354.9 mL)  
2 7/8" Dia. x 4 1/2" H (7.3 x 11.4 cm)

**FFHM45** Hammered Finish  
12 oz. (354.9 mL)  
2 7/8" Dia. x 4 1/2" H (7.3 x 11.4 cm)

## Mini Stainless Steel Fry Cups

A shorter take on our popular fry cup design, these pieces are great for mixing up your side service.

**FFCM2** Satin Finish  
7 oz. (207 mL)  
3 1/8" Dia. x 2" H (7.9 x 5.1 cm)

**FFHM2** Hammered Finish  
7 oz. (207 mL)  
3 1/8" Dia. x 2" H (7.9 x 5.1 cm)



Shown with  
FFHM37 fry cup,  
HAMSC and MBI sauce  
cups and MJ17 mason jar



OVERSIZED DESIGN FOR  
BIGGER BITES

### Large Stainless Steel Fry Cups

Don't let fries have all the fun. Serve appetizers, snacks and other sides in these stainless steel beauties.

**FFC335** Satin Finish  
24 oz. (709.8 mL)  
4" Dia. x 4 ½" H (10.2 x 11.4 cm)

**FFHM35** Hammered Finish  
24 oz. (709.8 mL)  
4" Dia. x 4 ½" H (10.2 x 11.4 cm)

### Square Hammered Fry Cups

Our popular stainless steel fry cups with a little more edge. (Four of them, to be exact.)

**FCH35** 12 oz. (354.9 mL)  
3 ¼" Sq. x 3 ½" H (8.3 x 8.9 cm)

**FCH325** 18 oz. (532.3 mL)  
3 ⅝" Sq. x 3 ⅝" H (9.2 x 9.2 cm)





NEW

FFCG337

FFCGH37

DISHWASHER-SAFE  
GOLD FINISH



NEW

### Gold Fry Cups <sup>NEW</sup>

Designed with modern in mind, our gold fry cups are offered in different shapes and finishes. Gold color may vary slightly.

#### Straight-Sided

**FFCG337** Satin Finish  
14 oz. (414 mL)  
3 3/8" Dia. x 3 3/8" H (8.6 x 8.6 cm)

**FFCGH37** Hammered Finish  
14 oz. (414 mL)  
3 3/8" Dia. x 3 3/8" H (8.6 x 8.6 cm)

#### Angled

**FFCG45** Satin Finish  
12 oz. (354.9 mL)  
2 7/8" Dia. x 4 1/2" H (7.3 x 11.4 cm)

**FFCGH45** Hammered Finish  
12 oz. (354.9 mL)  
2 7/8" Dia. x 4 1/2" H (7.3 x 11.4 cm)



FFCG45

FFCGH45

## Copper Fry Cups

Our most popular fry cup designs are available in upscale copper. Choose from brushed or hammered finishes in angled or straight-sided designs.

### Straight-Sided

**FFCCS337** Satin Finish  
14 oz. (414 mL)  
3 3/8" Dia. x 3 3/8" H (8.6 x 8.6 cm)

**FFCCH37** Hammered Finish  
14 oz. (414 mL)  
3 3/8" Dia. x 3 3/8" H (8.6 x 8.6 cm)

### Angled

**FFCCS45** Satin Finish  
12 oz. (354.9 mL)  
2 7/8" Dia. x 4 1/2" H (7.3 x 11.4 cm)

**FFCCH45** Hammered Finish  
12 oz. (354.9 mL)  
2 7/8" Dia. x 4 1/2" H (7.3 x 11.4 cm)



Shown with OWM17 olive wood melamine platter







### Stainless Steel Soup Cans

In black or silver, these cans elevate an easily overlooked object.

#### Silver

**SCSM** 12 oz. (354.9 mL)  
2 3/4" Dia. x 3 3/4" H (7 x 9.5 cm)

**SCS3** 12 oz. (354.9 mL)  
2 3/4" Dia. x 3 3/4" H (7 x 9.5 cm)

#### Black

**SCBM** 12 oz. (354.9 mL)  
2 3/4" Dia. x 3 3/4" H (7 x 9.5 cm)

**SCB3** 12 oz. (354.9 mL)  
2 3/4" Dia. x 3 3/4" H (7 x 9.5 cm)



Shown with SSP2 shakers and TMW13 serving tray

JC12



JC16

JC12

### Classic Mint Julep Cups

Featuring elegant beading and a mirrored finish, these stunning cups will have your mint julep presentation off to the races.

**JC12** 12 oz. (354.9 mL)  
3 3/8" Dia. x 4 1/2" H  
(8.6 x 11.4 cm)

**JC16** 16 oz. (473.2 mL)  
3 5/8" Dia. x 5 3/4" H  
(9.2 x 14.6 cm)

### Mint Julep Cups

Serve up Derby Day the other 364 days a year with these brushed stainless steel cups.

**JC8** 8 oz. (236.6 mL)  
2 7/8" Dia. x 3 7/8" H  
(7.4 x 9.8 cm)

**JC11** 11 oz. (325.3 mL)  
3" Dia. x 4 1/4" H  
(7.6 x 10.8 cm)

**JC14** 14 oz. (414 mL)  
3 1/4" Dia. x 4 5/8" H  
(8.3 x 11.8 cm)



JC11

JC14

JC8





GFC45

GFC335

GFC337

### Galvanized Fry Cups

With a French bistro look, these cups are a chic way to serve fries and dainty desserts. Not for use with acidic foods.

**GFC337** 12 oz. (354.9 mL)  
3 ¾" Dia. x 3 ¼" H (9.5 x 8.3 cm)

**GFC45** Angled, 10 oz. (295.7 mL)  
3 ½" Dia. x 4 ½" H (8.9 x 11.4 cm)

**GFC335** 24 oz. (709.8 mL)  
4 ¼" Dia. x 4 ½" H (10.8 x 11.4 cm)

### Mini Galvanized Pails

Pair with our larger pails (pg. 80) to stylishly coordinate. Not for use with acidic foods.

**GP2** 3 oz. (88.7 mL)  
2 ½" Dia. x 2 ¾" H (6.4 x 7 cm)

**GP3** 8 ½ oz. (251.4 mL)  
3 ½" Dia. x 3 ⅞" H (8.9 x 9.8 cm)

**GP4** 26 oz. (768.9 mL)  
4 ½" Dia. x 5" H (11.4 x 12.7 cm)



GP3

GP4

GP2

### Newspaper Fry Cups

A nod to traditional fish and chips presentation, retro newsprint is the inspiration for this press-worthy design. Sold in packs of 1000.

**FFCP4** 4 oz. (118.3 mL)  
2 ¾" Dia. x 4 ⅜" H (7 x 11.1 cm)

**FFCP6** 6 oz. (177.4 mL)  
2 ⅞" Dia. x 5 ¼" H (7.3 x 13.3 cm)



FFCP6

FFCP4

**Mini Stainless Steel Pails** HOT

- SSP25** 6 oz. (177.4 mL)  
2 1/2" Dia. x 2 3/4" H (6.4 x 7 cm)
- SSP35** 12 oz. (354.9 mL)  
3 1/2" Dia. x 3 1/4" H (8.9 x 8.3 cm)
- SSP43** 1 qt. (946.4 mL)  
5" Dia. x 4 5/8" H (12.7 x 11.7 cm)
- SSP61** 2 qt. (1.9 L)  
6 1/4" Dia. x 5 3/4" H (15.9 x 14.6 cm)

**HOT**

**Mini Stainless Steel Trash Cans**

- OSCAR** Can  
14 oz. (414 mL)  
3 3/4" Dia. x 3 1/2" H (9.5 x 8.9 cm)
- OLID** Lid for OSCAR  
3 3/4" Dia. x 1 1/2" H (9.5 x 3.8 cm)
- OSCAR2** Can  
1 qt. (946.4 mL)  
5" Dia. x 4 7/8" H (12.7 x 12.4 cm)
- OLID2** Lid for OSCAR2  
5" Dia. x 1 5/8" H (12.7 x 4.1 cm)
- OSCAR3** Can  
2 qt. (1.9 L)  
6" Dia. x 5 7/8" H (15.2 x 14.9 cm)
- OLID3** Lid for OSCAR3  
6" Dia. x 1 7/8" H (15.2 x 4.8 cm)



**Stainless Steel Milk Cans** HOT

- MICH25** 2 1/2 oz. (73.9 mL)  
2" Dia. x 2 1/4" H (5.1 x 5.7 cm)
- MICH5** 5 oz. (147.9 mL)  
2" Dia. x 3" H (5.1 x 7.6 cm)
- MICH10** 10 oz. (285.7 mL)  
3 1/8" Dia. x 4" H (7.9 x 10.2 cm)
- MICH15** 15 oz. (443.6 mL)  
2 3/4" Dia. x 5" H (7 x 12.7 cm)







**Fry and Basket Paper** **HOT**

FDA-approved, biodegradable, compostable, food-safe paper. Sold in packs of 1000.

**Flat 10" Square Paper (25.4 cm)**

- PPRW1010 White (not shown)
- PPCN1010 Natural Newspaper (not shown)
- PPCH3N Natural (not shown)
- PPRN100 Newspaper (not shown)

**Flat 12" Square Paper (30.5 cm)**

- PPRW1212 White
- PPCN1212 Natural Newspaper
- PPCH2N Natural
- PPRN2121 Newspaper
- PPCH1B Black Checkerboard
- PPCH3R Red Checkerboard

**Flat 16" Square Paper (40.6 cm)**

- PPRW1616 White
- PPCH4N Natural
- PPCN1616 Natural Newspaper (not shown)
- PPRN1616 Newspaper

**Preformed 7" L x 6" W Paper Bags (17.8 x 15.2 cm)**

- PPRC76 Natural Newspaper
- PPRN76 Newspaper





PPL12 shown with  
CKNF2 knife

### Leaf Cheese Paper

Conjure up a magical experience with your next cheese board or charcuterie. These clever, grease-resistant, food-safe papers are sure to surprise. **Sold in packs of 250.**

- PPL4** 4 ¼" L x 2 ½" W  
(10.8 x 6.3 cm)
- PPL7** 7" L x 4 ½" W  
(17.8 x 11.4 cm)
- PPL12** 12" L x 7" W  
(30.5 x 17.8 cm)

### Mini Snack Bags

Disposable and grease-resistant, these simple sacks aren't just for takeout. **Sold in packs of 250.**

#### Black

- SBB3** 3 ⅜" L x 1 ¾" W x 3 ½" H  
(8.6 x 4.4 x 8.9 cm)
- SBB4** 4 ¼" L x 2 ½" W x 3 ¾" H  
(10.8 x 6.3 x 9.5 cm)

#### White

- SBW3** 3 ⅜" L x 1 ¾" W x 3 ½" H  
(8.6 x 4.4 x 8.9 cm)
- SBW4** 4 ¼" L x 2 ½" W x 3 ¾" H  
(10.8 x 6.3 x 9.5 cm)

#### Natural

- SBN3** 3 ⅜" L x 1 ¾" W x 3 ½" H  
(8.6 x 4.4 x 8.9 cm)
- SBN4** 4 ¼" L x 2 ½" W x 3 ¾" H  
(10.8 x 6.3 x 9.5 cm)







## Enamelware

Vintage enamelware is ultra-hot, and this collection is a perfect way to get in on the Americana-inspired craze. Each piece features blue trim on white; a timeless look your customers will love.

- EWM6** Mug  
6 oz. (177.4 mL)  
2 7/8" Dia. x 2 3/4" H, 3 1/2" L with Handle  
(7.3 x 7, 8.9 cm)
- EWB6** Bowl  
8 oz. (236.6 mL)  
6 1/4" L x 4 7/8" W x 1 1/2" H  
(15.9 x 12.4 x 3.8 cm)
- EWM16** Mug  
16 oz. (473.2 mL)  
3 5/8" Dia. x 4" H, 4 1/2" L with Handle  
(9.2 x 10.2, 11.4 cm)
- EWB8** Bowl  
16 oz. (473.2 mL)  
7 7/8" L x 5 7/8" W x 1 1/2" H  
(20 x 14.9 x 3.8 cm)
- EWB10** Bowl  
32 oz. (946.4 mL)  
10" L x 7 5/8" W x 1 7/8" H  
(25.4 x 19.4 x 4.8 cm)



## Onyx Galvanized Wide Rim Pans

The days of using a standard aluminum pan for serving are over. You now have options! These dark galvanized pans are perfect for anything from pizza to burritos.

- GTP10** 10" Dia. x 3/8" H (25.4 x 1 cm)  
(not shown)
- GTP12** 12" Dia. x 3/8" H (30.5 x 1 cm)  
(not shown)
- GTP14** 14" Dia. x 3/8" H (35.6 x 1 cm)
- GTP16** 16" Dia. x 3/8" H (40.6 x 1 cm)  
(not shown)
- GTP18** 18" Dia. x 3/8" H (45.7 x 1 cm)  
(not shown)



## Square Wide-Rim Pans

Our most popular pizza serving pans have gotten a makeover. These Square Wide-Rim Pizza Pans expertly serve up anything from Sicilian to Detroit-Style pizzas. Made of durable 18-gauge aluminum, these pans can also double as modern serving trays in dining halls and quick serve restaurants.

- STP10** 10" Sq. (25.4 cm)
- STP12** 12" Sq. (30.5 cm)
- STP14** 14" Sq. (35.6 cm)
- STP16** 16" Sq. (40.6 cm)





### Stainless Steel Pie Pans

- 918SS** 9 1/8" Top OD x 7 7/8" Top ID x 6 7/8" Bottom ID x 1" Deep (23.2 x 20 x 17.5 x 2.5 cm)
- 1187SS** 10 1/8" Top OD x 9" Top ID x 8 1/8" Bottom ID x 3/4" Deep (25.7 x 22.9 x 20.6 x 1.9 cm)
- 1300SS** 13 1/8" Top OD x 11 7/8" Top ID x 10 3/4" Bottom ID x 7/8" Deep (33.3 x 30.2 x 27.3 x 2.2 cm)

### Aluminum Serving Pans USA

- 1188** 10" Top OD x 9" Top ID x 7 3/4" Bottom ID x 1 1/4" Deep (25.4 x 22.9 x 19.7 x 3.2 cm)
- 1190** 11 1/8" Top OD x 10" Top ID x 8 1/4" Bottom ID x 1 5/16" Deep (28.3 x 25.4 x 21 x 3.3 cm)
- 1200** 11 7/8" Top OD x 10 7/8" Top ID x 9 1/8" Bottom ID x 1 1/4" Deep (30.2 x 27.6 x 23.2 x 3.2 cm)
- 1300** 13 1/8" Top OD x 11 7/8" Top ID x 10 7/8" Bottom ID x 7/8" Deep (33.3 x 30.2 x 27.6 x 2.2 cm) (not shown)

### Mini Aluminum Pie Pan USA

- 475** 4 3/8" Top OD x 4" Top ID x 3" Bottom ID x 1" Deep (11.1 x 10.2 x 7.6 x 2.5 cm)







### Hammered Stainless Steel Tubs

These dishwasher-safe pieces are ideal for serving casual entrées like sandwiches and wraps.

- SHT9** Rectangle, 44 oz. (1.3 L)  
9 1/8" L x 6 1/8" W x 2" H  
(23.2 x 15.6 x 5.1 cm)
- SHT8** Square, 54 oz. (1.6 L)  
8" Sq. x 2" H (20.3 x 5.1 cm)
- SHT17** Rectangle, 54 oz. (1.6 L)  
10 1/8" L x 7 1/8" W x 2" H  
(25.7 x 18.1 x 5.1 cm)
- SHT10** Square, 90 oz. (2.7 L)  
10 1/4" Sq. x 2" H (26 x 5.1 cm)

### Stainless Steel Pails and Tubs

A dual satin and mirror finish dresses up this collection.

- STUB63** Tub, 27 oz. (798.5 mL)  
6 1/8" Dia. x 3" H (15.6 x 7.6 cm)
- STUB69** Oval Tub, 32 oz. (946.4 mL)  
8 3/4" L x 5 5/8" W x 2 1/4" H  
(22.2 x 14.2 x 5.7 cm)
- STUB83** Tub, 37 oz. (1.1 L)  
8 1/4" Dia. x 3 1/4" H (21 x 8.3 cm)
- STUB93** Tub, 72 oz. (2.1 L)  
8 7/8" Dia. x 3 1/4" H (22.5 x 8.3 cm)
- STUB10** Tub, 88 oz. (2.6 L)  
9 3/4" Dia. x 3 1/4" H (24.8 x 8.3 cm)
- STUB12** Tub, 95 oz. (2.8 L)  
12 1/4" Dia. x 3 1/8" H (31.1 x 7.9 cm)
- STUB87** Pail, 148 oz. (4.4 L)  
8 1/4" Dia. x 7 1/8" H (21 x 18.1 cm)
- STUB20** Tub, 25 qt. (24 L)  
20" L x 15" W x 11" H  
(50.8 x 38.1 x 27.9 cm)



### Natural Galvanized

#### Pails and Tubs HOT

Hand-wash only. Not for use with acidic foods.

- MTUB63** Tub, 27 oz. (798.5 mL)  
6 1/8" Dia. x 3" H (15.6 x 7.6 cm)
- MTUB69** Oval Tub, 32 oz. (946.4 mL)  
8 3/4" L x 5 1/8" W x 2 1/4" H  
(22.2 x 13 x 5.7 cm)
- MTUB83** Tub, 37 oz. (1.1 L)  
8" Dia. x 3" H (20.3 x 7.6 cm)
- MTUB93** Tub, 72 oz. (2.1 L)  
8 7/8" Dia. x 3 1/4" H (22.5 x 8.3 cm)
- MTUB10** Tub, 88 oz. (2.6 L)  
9 3/4" Dia. x 3 1/4" H (24.8 x 8.3 cm)
- MTUB12** Tub, 95 oz. (2.8 L)  
11 3/4" Dia. x 3 1/4" H (29.5 x 8.3 cm)
- PTUB87** Pail, 148 oz. (4.4 L)  
8 1/4" Dia. x 7 1/8" H (21 x 18.1 cm)
- GPTUB20** Tub, 25 qt. (24 L)  
19 5/8" L x 15 1/4" W x 11" H  
(49.8 x 38.7 x 27.9 cm)



## Hammered Aluminum Entrée Baskets and Cups

In cool contemporary tones, these personal-sized tubs are perfect for presenting all kinds of entrées and sides. Your customers will love the artisanal aesthetic created by the individually hammered design.

### Gold

**ASPG** Sugar Packet Holder/Sauce Cup  
6 oz. (177.4 mL)  
3 3/8" L x 2 3/8" W x 2" H  
(8.3 x 6 x 5.1 cm)

**ABHG46** 25 oz. (739.3 mL)  
6 1/2" L x 4 3/4" W x 2 1/4" H  
(16.5 x 12.1 x 5.7 cm)

**ABHG69** 48 oz. (1.4 L)  
9" L x 6" W x 2 1/4" H  
(22.9 x 15.2 x 5.7 cm)

### Copper

**ASPC** Sugar Packet Holder/Sauce Cup  
6 oz. (177.4 mL)  
3 3/8" L x 2 3/8" W x 2" H  
(8.6 x 6 x 5.1 cm)

**ABHC46** 25 oz. (739.3 mL)  
6 1/2" L x 4 3/4" W x 2 1/4" H  
(16.5 x 12.1 x 5.7 cm)

**ABHC69** 48 oz. (1.4 L)  
9" L x 6" W x 2 1/4" H  
(22.9 x 15.2 x 5.7 cm)

### Silver

**ASPS** Sugar Packet Holder/Sauce Cup  
6 oz. (177.4 mL)  
3 3/8" L x 2 3/8" W x 2" H  
(8.6 x 6 x 5.1 cm)

**ABHS46** 25 oz. (739.3 mL)  
6 1/2" L x 4 3/4" W x 2 1/4" H  
(16.5 x 12.1 x 5.7 cm)

**ABHS69** 48 oz. (1.4 L)  
9" L x 6" W x 2 1/4" H  
(22.9 x 15.2 x 5.7 cm)

### Black

**ASPB** Sugar Packet Holder/Sauce Cup  
6 oz. (177.4 mL)  
3 3/8" L x 2 3/8" W x 2" H  
(8.6 x 6 x 5.1 cm)

**ABHB46** 25 oz. (739.3 mL)  
6 1/2" L x 4 3/4" W x 2 1/4" H  
(16.5 x 12.1 x 5.7 cm)

**ABHB69** 48 oz. (1.4 L)  
9" L x 6" W x 2 1/4" H  
(22.9 x 15.2 x 5.7 cm)





OUR POPULAR SQUOUND BOWLS NOW  
AVAILABLE IN HAMMERED STAINLESS STEEL



### Squound Hammered Bowls

- SBH3** 40 oz. (1.2 L)  
7" Dia. x 2 1/8" H (17.8 x 5.4 cm)
- SBH5** 67 oz. (2 L)  
9" Dia. x 2 3/4" H (22.9 x 7 cm)
- SBH7** 126 oz. (3.7 L)  
11" Dia. x 3" H (27.9 x 7.6 cm)

### Squound Hammered Snack Bowls

- SBH325** 3 oz. (100 mL)  
3 1/8" Dia. x 1 1/2" H (7.9 x 3.8 cm)
- SBH400** 5 1/2 oz. (200 mL)  
3 7/8" Dia. x 1 5/8" H (9.8 x 4.1 cm)
- SBH450** 9 1/2 oz. (300 mL)  
4 1/2" Dia. x 2 1/2" H (11.4 x 6.4 cm)
- SBH575** 15 oz. (400 mL)  
5 3/4" Dia. x 2 1/2" H (14.6 x 6.4 cm)

### Moroccan Hammered Bowls

These one-of-a-kind stainless steel bowls are great serving vessels for global cuisine and practically anything else.

- HB5** 16 oz. (473.2 mL)  
5" Dia. x 2" H (12.7 x 5.1 cm)
- HB6** 27 oz. (798.5 mL)  
6" Dia. x 2 1/2" H (15.2 x 6.4 cm)
- HB7** 38 oz. (1.1 L)  
6 3/4" Dia. x 2 3/4" H (17.1 x 7 cm)





### Squound Stainless Steel Bowls

Pair stainless steel with cutting-edge shapes, and you get some of the most contemporary serving bowls on the market.

- SB3** 40 oz. (1.2 L)  
7" Dia. x 2 1/8" H (17.8 x 5.4 cm)
- SB5** 67 oz. (2 L)  
9" Dia. x 2 3/4" H (22.9 x 7 cm)
- SB7** 126 oz. (3.7 L)  
11" Dia. x 3" H (27.9 x 7.6 cm)

### Squound Stainless Steel Snack Bowls

- SB325** 3 oz. (100 mL)  
3 1/8" Dia. x 1 1/2" H (7.9 x 3.8 cm)
- SB400** 5 1/2 oz. (200 mL)  
3 7/8" Dia. x 1 5/8" H (9.8 x 4.1 cm)
- SB450** 9 1/2 oz. (300 mL)  
4 1/2" Dia. x 2 1/2" H (11.4 x 6.4 cm)
- SB575** 15 oz. (400 mL)  
5 3/4" Dia. x 2 1/2" H (14.6 x 6.4 cm)







PWRB10

PWRB12



PWBB12

PWBB10

### Rectangular Poplar Wood Boxes

Farm-to-table never looked so tempting. Use these boxes for baked goods, dry storage and produce for a hand-crafted aesthetic.

#### Natural

**PWRB10** 8 1/2" L x 5 3/4" W x 2 3/4" H  
(21.6 x 14.6 x 7 cm)

**PWRB12** 12 3/8" L x 7 1/4" W x 2 3/4" H  
(31.4 x 18.4 x 7 cm)

#### Black

**PWBB10** 8 1/2" L x 5 3/4" W x 2 3/4" H  
(21.6 x 14.6 x 7 cm)

**PWBB12** 12 3/8" L x 7 1/4" W x 2 3/4" H  
(31.4 x 18.4 x 7 cm)





### Kraft Bags

Paper bags that you can wash and reuse? It is now a reality with these innovative bread bags. Available in black and khaki colors with contrasting white stitching and foldable rims, each bag is machine washable for extended use.

#### Black

- KBB5** 5" Dia. x 4" H (12.7 x 10.2 cm)
- KBB7** 7" Dia. x 4" H (17.8 x 10.2 cm)
- KBB9** 9" Dia. x 10 3/8" H (22.9 x 26.4 cm)

#### Khaki

- KBK5** 5" Dia. x 4" H (12.7 x 10.2 cm)
- KBK7** 7" Dia. x 4" H (17.8 x 10.2 cm)
- KBK9** 9" Dia. x 10 3/8" H (22.9 x 26.4 cm)

### Canvas Bags

These cream and gray canvas bags add a rustic feel to table settings. Pre-shrunk and machine-washable.

- TV3** 6 1/2" Dia. x 4 1/8" H (16.5 x 10.5 cm)
- TV4** 7 3/4" Dia. x 4 7/8" H (19.7 x 12.4 cm)
- TV6** 8" L x 6" W x 4" H (20.3 x 15.2 x 10.2 cm)
- TV8** 9 3/4" L x 7" W x 5" H (24.8 x 17.8 x 12.7 cm)
- TV9** 9" Dia. x 10 3/8" H (22.9 x 26.4 cm)







**FBC92** shown with MRS300BL ramekins

**FBS591** shown with MRS300BL ramekins

**FFB59**

### Wrought Iron One-Cone Conical Baskets

- FFB59** One-Cone Basket  
5" Dia. x 9" H (12.7 x 22.9 cm)
- FBS591** One-Cone Basket with One Ramekin Holder  
(1) 3 oz. (88.7 mL) Ramekin included  
5" Dia. x 9" H (12.7 x 22.9 cm)
- FBC92** One-Cone Basket with Two Ramekin Holders  
(2) 3 oz. (88.7 mL) Ramekins included  
5" Dia. x 9" H (12.7 x 22.9 cm)

### Flat Coil Wrought Iron Conical Baskets

- FCD1** 5" Dia. x 6 ¾" H  
(12.7 x 17.1 cm)
- FCD2** 7" Dia. x 6" H  
(17.8 x 15.2 cm)

### Flat Coil Wrought Iron Slanted Conical Basket

- FWB4** 4 ½" Dia. x 7 ½" H  
(11.4 x 19 cm)

### Stainless Steel Conical Baskets

- SS59** One-Cone Basket  
5" Dia. x 9" H (12.7 x 22.9 cm)
- SS92** One-Cone Basket with Two Ramekin Holders  
(2) 3 oz. (88.7 mL) Ramekins included  
5" Dia. x 9" H (12.7 x 22.9 cm)



**FCD2**

**FCD1**



**FWB4**



**SS92** shown with MRS300BL ramekins

**SS59**

## Two-Tier Wrought Iron Basket

This seemingly hand-twisted basket would look as comfortable in an art museum as it will in your dining room.

**TTDB2** Two-Tier Basket  
13" Top Dia. x 15" Bottom Dia. x 19 5/8" H  
(33 x 38.1 x 49.9 cm)

## Square Fry Cone Holders and Cardboard Cones

**SQFBSS** Stainless Steel  
2 1/2" Sq. Top x 3 5/8" Round Base x 5 1/4" H  
(6.4 x 9.2 x 13.3 cm)

**SQFBBL** Black   
2 1/2" Sq. Top x 3 5/8" Round Base x 5 1/4" H  
(6.4 x 9.2 x 13.3 cm)

### Square Cardboard Cones

**SQFBCN10** 10 oz. (295.7 mL)  
4" Tapered Opening x 7 1/4" H  
(10.2 x 18.4 cm)  
**Pack of 100**

**SQFBCN** 15 oz. (443.6 mL)  
4 3/4" Tapered Opening x 10 3/4" H  
(12.1 x 27.3 cm)  
**Pack of 100**

## Stainless Steel Conical Snack Holder

A smooth satin finish and sophisticated shape add a futuristic twist to this conical fry holder.

**SSFC7** Standard  
4 1/2" Dia. x 7" H  
(11.4 x 17.8 cm)



SSFC7



TTDB2



PREFOLDED  
CONES FEATURE  
A FOLDOUT  
CONDIMENT  
POCKET

SQFBBL shown  
with SQFBCN cone

SQFBSS shown with  
SQFBCN10 cone





## Mini Fry Baskets HOT

Everyone loves the classic design and easy storage of our fry baskets. They're great for serving up any side, not just fried foods.

### Stainless Steel

**FRYT433** Rectangular  
4 1/8" L x 3 3/8" W x 3" H  
with 3 1/2" Handle  
(10.5 x 8.6 x 7.6, 8.9 cm)

**FRYS443** Square  
4" Sq. x 3" H  
with 3 1/2" Handle  
(10.2 x 7.6, 8.9 cm)

### Black

**FRYB433** Rectangular  
4 1/8" L x 3 3/8" W x 3" H  
with 3 1/2" Handle  
(10.5 x 8.6 x 7.6, 8.9 cm)

**FRYB443** Square  
4" Sq. x 3" H  
with 3 1/2" Handle  
(10.2 x 7.6, 8.9 cm)



## Round Stainless Steel Fry Basket

**FRYR375** Round  
3 1/2" Dia. x 2 3/4" H  
with 4" Handle  
(8.9 x 7, 10.2 cm)



FRYR375

Shown with PSLT17 sauce cup





MSQBSKT

MFRYBSKT

### Stainless Steel Fry Baskets

**MSQBSKT** Square  
5" Sq. x 3" H  
with 3 3/4" Handle  
(12.7 x 7.6, 9.5 cm)

**MFRYBSKT** Rectangular  
5" L x 4" W x 3" H  
with 3 3/4" Handle  
(12.7 x 10.2 x 7.6, 9.5 cm)

### Stainless Steel Mini Snack Baskets

Our popular fry baskets are now available without handles.

**FBSR43** Rectangular  
4 1/8" L x 3 3/8" W x 3" H  
(10.5 x 8.6 x 7.6 cm)

**FBSS44** Square  
4" Sq. x 3" H  
(10.2 x 7.6 cm)



FBSS44

FBSR43





NESTABLE DESIGN  
SAVES ON SPACE IN  
THE BACK OF THE HOUSE



NEW

### Laser Cut Fry Baskets

Sleek, stylish and contemporary, these baskets offer a modern twist on the traditional fry basket. Each item is expertly crafted and laser cut from stainless steel to provide a precise design with every piece. Dishwasher-safe gold finish. Color may vary slightly.

#### Silver

- LFRY44** Square  
4" Sq. x 3" H (10.2 x 7.6 cm)
- LFRY43** Rectangle  
4 1/8" L x 3 3/8" W x 3" H  
(10.5 x 8.6 x 7.6 cm)
- LFRY55** Square  
5" Sq. x 3" H (12.7 x 7.6 cm)
- LFRY54** Rectangle  
5" L x 4" W x 3" H (12.7 x 10.2 x 7.6 cm)
- LPLT10** Rectangular Platter  
10" L x 7" W x 1" H (25.4 x 17.8 x 2.5 cm)

#### Gold

- LFRYG44** Square  
4" Sq. x 3" H (10.2 x 7.6 cm)
- LFRYG43** Rectangle  
4 1/8" L x 3 3/8" W x 3" H  
(10.5 x 8.6 x 7.6 cm)
- LFRYG55** Square  
5" Sq. x 3" H (12.7 x 7.6 cm)
- LFRYG54** Rectangle  
5" L x 4" W x 3" H (12.7 x 10.2 x 7.6 cm)
- LPLTG10** Rectangular Platter  
10" L x 7" W x 1" H (25.4 x 17.8 x 2.5 cm)



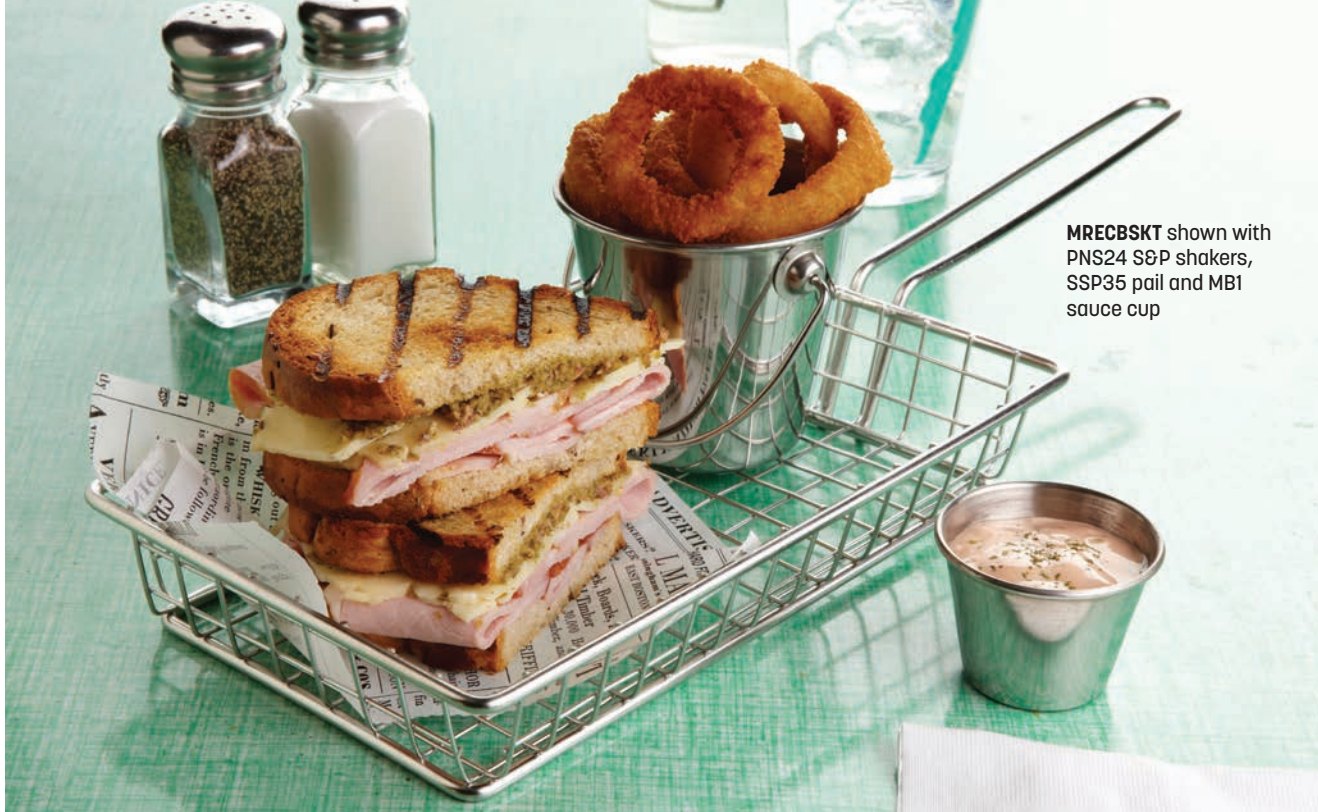

MRECBSKT shown with  
PNS24 S&P shakers,  
SSP35 pail and MB1  
sauce cup

### Rectangular Fry Basket

MRECBSKT 9 1/2" L x 6" W x 1 1/2" H  
with 4" Handle  
(24.1 x 15.2 x 3.8, 10.2 cm)

### Rectangular Grid Baskets

#### Small

RMB95B Black  
 9" L x 6" W x 2 1/2" H  
(22.9 x 15.2 x 6.4 cm)

RMB59C Chrome  
 9" L x 6" W x 2 1/2" H  
(22.9 x 15.2 x 6.4 cm)

SSRT962 Stainless Steel  
9" L x 6" W x 2 1/2" H  
(22.9 x 15.2 x 6.4 cm)

#### Large

GCRB2613 Black  
 13" L x 6" W x 2 1/2" H  
(33 x 15.2 x 6.4 cm)

GCRC1362 Chrome  
 13" L x 6" W x 2 1/2" H  
(33 x 15.2 x 6.4 cm)

GCSS6132 Stainless Steel  
13" L x 6" W x 2 1/2" H  
(33 x 15.2 x 6.4 cm)



RMB59C

RMB95B shown with  
FFC337 fry cup

SSRT962



GCRB2613

GCSS6132

GCRC1362 shown with  
FRYR375 fry basket and  
MRF350W ramekin





SQGS10 shown with SSP35 mini pail and MB1 sauce cup

SQGS6

SQGS8

SQGS12

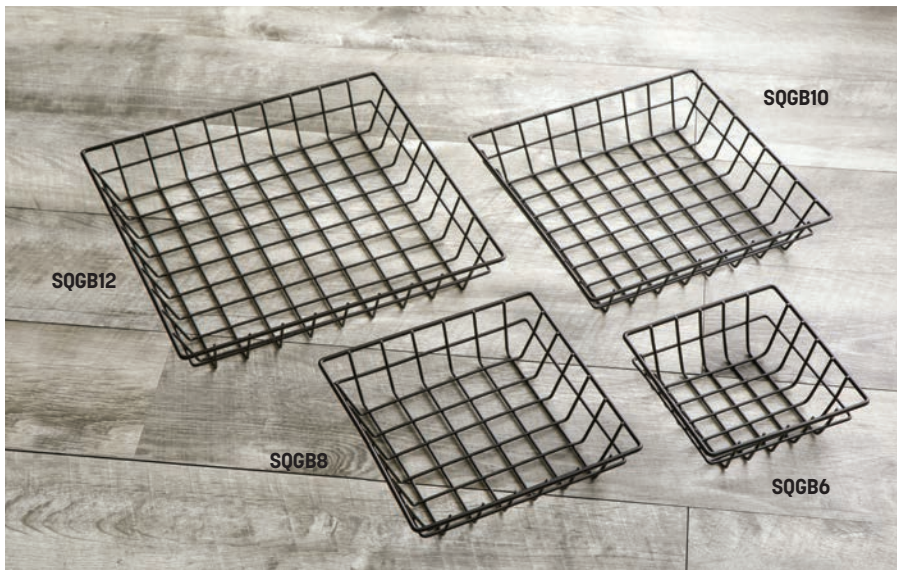

### Square Grid Baskets

The classic, squared. Our popular wire baskets now come in multiple square sizes. Think beyond the plate for burgers and fries, sandwiches or appetizers.

#### Stainless Steel

- SQGS6** 6" Sq. x 2" H  
(15.2 x 5.1 cm)
- SQGS8** 8" Sq. x 2" H  
(20.3 x 5.1 cm)
- SQGS10** 10" Sq. x 2" H  
(25.4 x 5.1 cm)
- SQGS12** 12" Sq. x 2" H  
(30.4 x 5.1 cm)

#### Black

- SQGB6** 6" Sq. x 2" H  
(15.2 x 5.1 cm)
- SQGB8** 8" Sq. x 2" H  
(20.3 x 5.1 cm)
- SQGB10** 10" Sq. x 2" H  
(25.4 x 5.1 cm)
- SQGB12** 12" Sq. x 2" H  
(30.4 x 5.1 cm)





### Round Grid Baskets

In stainless steel or black, these grid-bottomed baskets can be dressed to look retro or futuristic.

#### Stainless Steel

**WISS8** 8" Dia. x 2" H  
(20.3 x 5.1 cm)

**WISS10** 10" Dia. x 2" H  
(25.4 x 5.1 cm)

**WISS12** 12" Dia. x 2" H  
(30.5 x 5.1 cm)

#### Black

**WIB80** 8" Dia. x 2" H  
(20.3 x 5.1 cm)

**WIB100** 10" Dia. x 2" H  
(25.4 x 5.1 cm)

**WIB120** 12" Dia. x 2" H  
(30.5 x 5.1 cm)







GOVB811 shown with PPRN2121 fry paper and HAMSC25 sauce cup

GOVB69

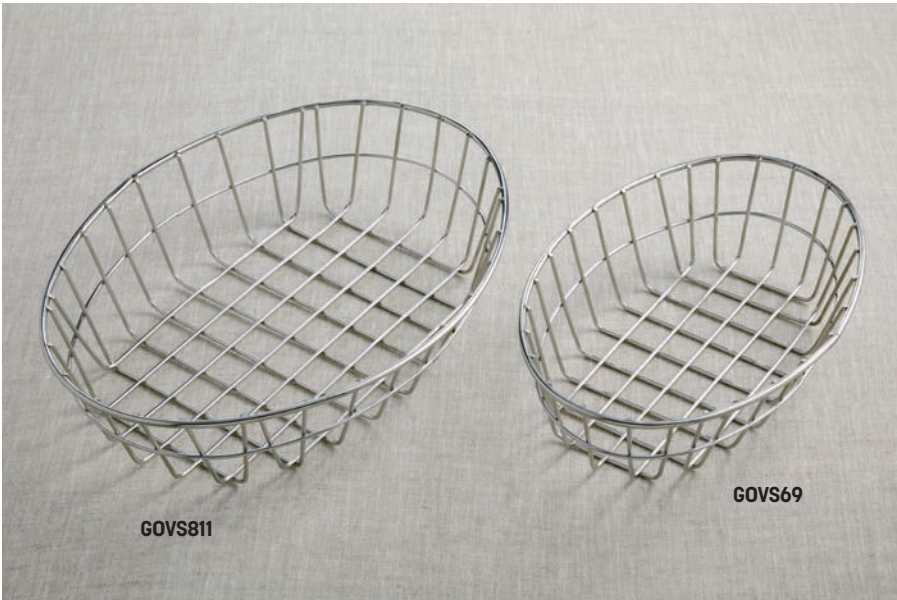

GOVS811

GOVS69

### Oblong Grid Baskets

In your choice of black or stainless steel, these stylish baskets are perfect for serving casual entrées and appetizers with panache.

#### Black

- GOVB69 9" L x 6" W x 2 1/2" H (22.9 x 15.2 x 6.4 cm)
- GOVB811 11" L x 8" W x 2 1/2" H (27.9 x 20.3 x 6.4 cm)

#### Stainless Steel

- GOVS69 9" L x 6" W x 2 1/2" H (22.9 x 15.2 x 6.4 cm)
- GOVS811 11" L x 8" W x 2 1/2" H (27.9 x 20.3 x 6.4 cm)





BZZ95B

BZZ59C



ROC1362

ROB2613 shown with  
FFB59 conical basket

## Zorro Baskets

### Small

**BZZ95B** Black  
9" L x 6" W x 2 1/2" H  
(22.9 x 15.2 x 6.4 cm)

**BZZ59C** Chrome  
9" L x 6" W x 2 1/2" H  
(22.9 x 15.2 x 6.4 cm)

### Large

**ROB2613** Black  
13" L x 6" W x 2 1/2" H  
(33 x 15.2 x 6.4 cm)

**ROC1362** Chrome  
13" L x 6" W x 2 1/2" H  
(33 x 15.2 x 6.4 cm)

## Loop-D-Loop Baskets

### Small

**EBB59B** Black  
9" L x 6" W x 2 1/2" H  
(22.9 x 15.2 x 6.4 cm)

**EBB95C** Chrome  
9" L x 6" W x 2 1/2" H  
(22.9 x 15.2 x 6.4 cm)

### Large

**LDLB2613** Black  
13" L x 6" W x 2 1/2" H  
(33 x 15.2 x 6.4 cm)

**LDLC1362** Chrome  
13" L x 6" W x 2 1/2" H  
(33 x 15.2 x 6.4 cm)



EBB59B

EBB95C



LDLB2613

LDLC1362





BLLB94

BLSB93

BLSB80

BLLB81



OSC9

OLB9

### IRONWORKS™ BASKETS

Whether you're serving breads, sandwiches or snacks, our Ironworks Collection twists hearty wrought iron and steel into artisanal showstoppers.

#### Round Wrought Iron Bread Baskets

**BLLB81** Leaf, 8" Dia. x 3" H  
(20.3 x 7.6 cm)

**BLLB94** Leaf, 9" Dia. x 3 5/8" H  
(22.9 x 9.2 cm)

**BLSB80** Scroll, 8" Dia. x 3" H  
(20.3 x 7.6 cm)

**BLSB93** Scroll, 9" Dia. x 3 5/8" H  
(22.9 x 9.2 cm)

#### Oval Wrought Iron Bread Baskets

**OSC9** Scroll, 6 3/4" L x 9" W  
(17.1 x 22.9 cm)

**OLB9** Leaf, 6 3/4" L x 9" W  
(17.1 x 22.9 cm)



Shown with PRSD3 sauce cup



Shown with DXP4 S&amp;P shakers

### BIRDNEST BASKETS

Our Birdnest Baskets feature a lightweight yet sturdy construction. Choose from a variety of shapes and styles in black or chrome.

#### Round Baskets

**FRUB9** Black, 7" Dia. x 5" H  
(17.8 x 12.7 cm)

**FRUC7** Chrome, 7" Dia. x 5" H  
(17.8 x 12.7 cm)

#### Disposable Liner

**WBCLINER** PET Liner  
for 7" Dia. baskets

#### Oval Baskets

**FRUB18** Black, 9" L x 6" W x 3" H  
(22.9 x 15.2 x 7.6 cm)

**FRUC16** Chrome, 9" L x 6" W x 3" H  
(22.9 x 15.2 x 7.6 cm)

#### Square Baskets/Risers

**BNRB64B** Black, 6" Sq. Top  
x 4" Sq. Bottom x 4" H  
(15.2 x 10.2 x 10.2 cm)

**BNRB86B** Black, 8" Sq. Top  
x 6" Sq. Bottom x 4" H  
(20.3 x 15.2 x 10.2 cm)

**BNRB46C** Chrome, 6" Sq. Top  
x 4" Sq. Bottom x 4" H  
(15.2 x 10.2 x 10.2 cm)

**BNRB68C** Chrome, 8" Sq. Top  
x 6" Sq. Bottom x 4" H  
(20.3 x 15.2 x 10.2 cm)







BSKB80 shown with  
MRS200BL ramekin

BSKC08



BSKB96

BSKC69 shown with  
MRS200W ramekins

### Round Wire Baskets with Ramekin Holders

**BSKB80** Black  
8" Dia. x 3 3/4" H  
(20.3 x 9.5 cm)

**BSKC08** Chrome  
8" Dia. x 3 3/4" H  
(20.3 x 9.5 cm)

### Oblong Wire Baskets with Ramekin Holders

**BSKB96** Black  
9" L x 6" W x 4" H  
(22.9 x 15.2 x 10.2 cm)

**BSKC69** Chrome  
9" L x 6" W x 4" H  
(22.9 x 15.2 x 10.2 cm)

HOT





BSKB811 shown with  
MRS200BL ramekins

BSKC118

### Oval Wire Baskets with Ramekin Holders-Mesh Bottom HOT

With stylishly retro curves and your choice of finish, these durable baskets are great for sandwich and entrée service.

**BSKB811** Black  
 11" L x 8" W x 3 1/4" H  
 (27.9 x 20.3 x 8.3 cm)

**BSKC118** Chrome  
 11" L x 8" W x 3 1/4" H  
 (27.9 x 20.3 x 8.3 cm)

#### Smooth Ramekins

**MRS200W** White, 2 oz. (59.1 mL)

**MRS200BL** Black, 2 oz. (59.1 mL)

#### Fluted Ramekins

**MRF250W** White, 2 oz. (59.1 mL)

**MRF250BL** Black, 2 oz. (59.1 mL)

### Onion Ring Spindles

Take your onion ring and bagel presentation to new heights with these stainless steel spindles. Fits round and oval baskets (sold separately).

**ORHC1** Round Base  
 5 1/4" Dia. x 9" H  
 (13.3 x 22.9 cm)

**ORH02** Oval Base  
 6 1/4" L x 4" W x 9" H  
 (15.9 x 10.2 x 22.9 cm)



ORHC1 shown with  
BSKC08 basket and  
MRF250BL ramekins

ORH02 shown with  
BSKC69 basket and  
MRF250BL ramekins







**WBBR80** shown with  
RGJ4 glass jar and  
PPCH4N natural paper

**WBBV90**

## Black Wire Baskets

These essential baskets set the stage for entrées and appetizers alike. Elegant, sleek and absolutely eye-catching.

**WBBV90** Oval  
9" L x 6" W x 2 ¾" H  
(22.9 x 15.2 x 7 cm)

**WBBR80** Round  
8" Dia. x 2 ¾" H  
(20.3 x 7 cm)

## Bronze Wire Baskets

A beautiful bronze finish on an attractive wire design, perfect for presenting rolls, breads and biscuits.

### Round

**WBBS** 5" Dia. x 3 ⅛" H  
(12.7 x 7.9 cm)

**WBBM** 7" Dia. x 4 ¼" H  
(17.8 x 10.8 cm)

### Oval

**WBB9** 9" L x 6" W x 2 ¼" H  
(22.9 x 15.2 x 5.7 cm)

**WBB11** 11" L x 8" W x 2 ½" H  
(27.9 x 20.3 x 6.4 cm)



**WBBM** shown with  
PPCH2N natural paper

**WBBS**



**WBB11**

**WBB9**

### Black Mesh Bottom Baskets

These simple, functional wrought iron baskets come in your choice of size and design.

**SSB28** Straight-Sided Round  
8" Dia. x 2 ½" H  
(20.3 x 6.4 cm)

**SSB96** Straight-Sided Oval  
9" L x 6" W x 2 ½" H  
(22.9 x 15.2 x 6.4 cm)

**WSB82** Wavy-Sided Round  
8" Dia. x 2 ½" H  
(20.3 x 6.4 cm)

**WSB69** Wavy-Sided Oval  
9" L x 6" W x 2 ½" H  
(22.9 x 15.2 x 6.4 cm)

### Chix Wire Baskets

In black or chrome, these rustic baskets bring homey authenticity to your presentation.

**WIR4** Black Oval  
9 ½" L x 6 ½" W x 2 ½" H  
(24.1 x 16.5 x 6.4 cm)

**WIR3** Chrome Oval  
9 ½" L x 6 ½" W x 2 ½" H  
(24.1 x 16.5 x 6.4 cm)

### Go-Go Baskets

**WCW69** Silver Oval  
9" L x 6" W x 3" H  
(22.9 x 15.2 x 7.6 cm)

**WCW81** Silver Round  
8" Dia. x 2 ⅞" H  
(20.3 x 7.3 cm)

**WBW96** Black Oval  
9" L x 6" W x 3" H  
(22.9 x 15.2 x 7.6 cm)

**WBW80** Black Round  
8" Dia. x 2 ⅞" H  
(20.3 x 7.3 cm)

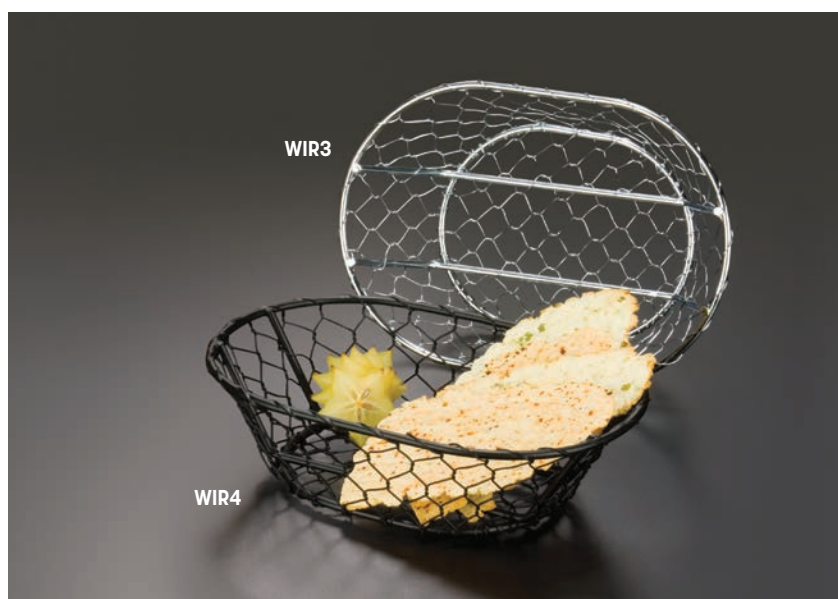
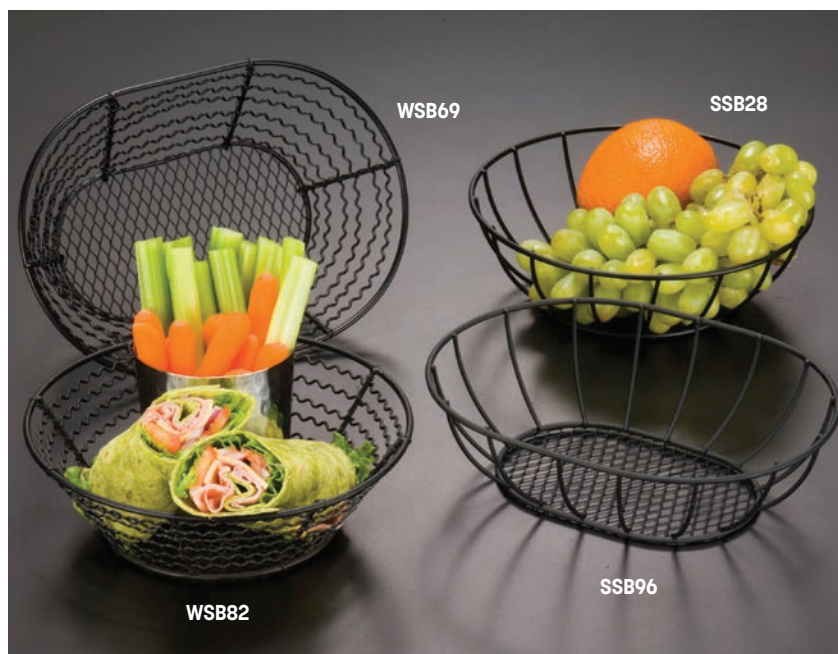





OBS913

BSS11

BSS7

OBS69

BSS8

OBS58

FRUB12

FRUC10

### Stainless Steel Baskets

Available in oval and round shapes and three different sizes.

#### Oval

**OBS58** 7 7/8" L x 5 5/8" W x 3" H  
(20 x 14.3 x 7.6 cm)

**OBS69** 9 1/8" L x 7" W x 3" H  
(23.2 x 17.8 x 7.6 cm)

**OBS913** 13 3/8" L x 9 3/8" W x 4 1/2" H  
(34 x 23.8 x 11.4 cm)

#### Round

**BSS7** 6 5/8" Dia. x 2 3/4" H  
(16.8 x 7 cm)

**BSS8** 8" Dia. x 2 7/8" H  
(20.3 x 7.3 cm)

**BSS11** 11" Dia. x 4 1/4" H  
(27.9 x 11 cm)

### Round Thatch Baskets

These unique baskets are ideal for serving baked goods in an intimate setting, or even for a memorable sandwich presentation.

**FRUB12** Black  
8" Dia. x 3 5/8" H  
(20.3 x 9.2 cm)

**FRUC10** Chrome  
8" Dia. x 3 5/8" H  
(20.3 x 9.2 cm)

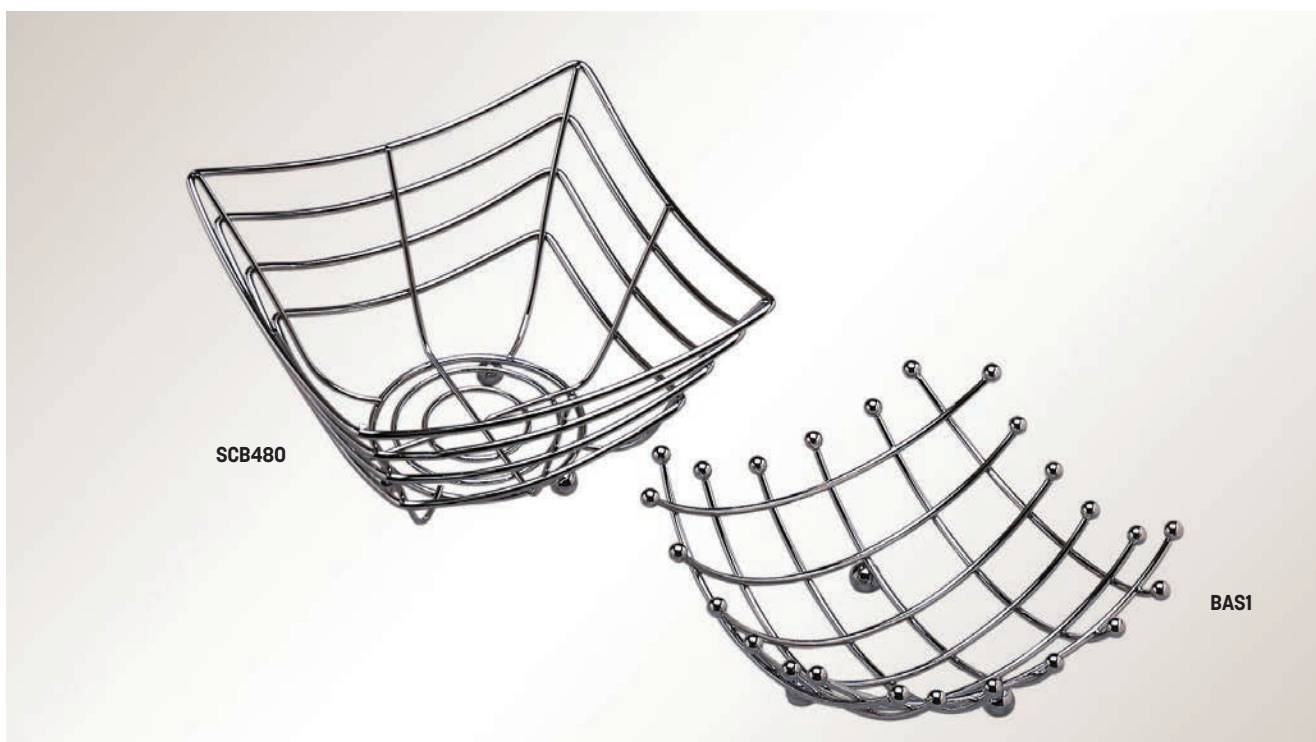

### Space/Time Continuum Chrome Baskets

Retro-futurism is timeless, and these chic baskets are proof.

**SCB480** Square Web  
8 ¼" Sq. x 4 ½" H (21 x 11.4 cm)

**BAS1** Checker  
8" Sq. x 2 ¾" H (20.3 x 7 cm)

### Round Wire Baskets

Available in chrome or black wire. A plastic liner is also available.

**BWB750** Black  
7" Dia. x 5" H (17.8 x 13 cm)

**WBC705** Chrome  
7" Dia. x 5" H (17.8 x 13 cm)



### Disposable Liner

**WBCLINER** PET Liner for 7" Dia. Baskets  
(not shown)



Shown with GLADT6,  
3307 and BEE319 shakers



SCAW7



USE TO CREATE A FRESH  
CONDIMENT STATION

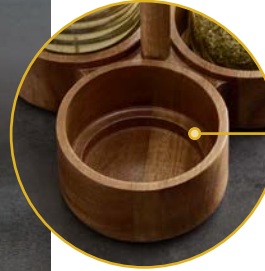

FITS AN ASSORTMENT  
OF SHAKERS DUE  
TO BUILT-IN LEDGE

### Loft Collection Acacia Wood Shaker Caddy

Stylishly bring the condiments to the table with this beautifully designed caddy from the Loft Collection. Made of intricately grained Acacia wood, this caddy includes three holders for a trio of shakers or loose condiments. The smart inset design allows for a solid fit for most 6 to 12 oz. shakers. Knockdown handle also allows for smart shipping and storage.

**SCAW7** 7" L x 6 1/2" W x 8 5/8" H  
(17.8 x 16.5 x 21.9 cm)  
Fits Most 6 oz. (177.4 mL) to  
12 oz. (354.9 mL) Shakers



NEW

CCAW9

CCAW8

CCAW7

### Loft Collection Condiment Caddies

Rustic beauty just radiates from these acacia wood caddies. Designed to organize tabletop essentials like condiments, spices and rolled flatware, each caddy conveniently includes a notched handle for table number cards.

**CCAW7** 7 1/4" Dia. x 10" H  
(18.4 x 25.4 cm)

**CCAW8** 8 3/8" Dia. x 10" H  
(21.3 x 25.4 cm)

**CCAW9** 9 1/8" L x 7 1/8" W x 10" H  
(23.2 x 18.1 x 25.4 cm)



CSM2 shown with OWP13 olive wood peel

CSM3

CSM40 shown with 4406 and GLADT6 shakers

### Jumbo Stainless Steel Soup Cans

Whether you use them as risers or condiment holders, these rustic cans offer versatile solutions with a memorable twist.

- CSM40** 40 oz. (1.2 L)  
6 1/4" Dia. x 3" H (15.9 x 7.6 cm)
- CSM2** 2 qt. (1.9 L)  
5 1/4" Dia. x 6" H (13.3 x 15.2 cm)
- CSM3** 3 1/4 qt. (3.1 L)  
6 1/4" Dia. x 7" H (15.9 x 17.8 cm)

### Contemporary Condiment Racks

These brushed stainless steel and black condiment holders feature a laser-cut design for a modern, upscale look.

#### Stainless Steel

- SCH6** 6 1/4" Dia. x 9 1/4" H  
(15.9 x 23.5 cm)
- SCH7** 7 3/4" Dia. x 9 1/2" H  
(19.7 x 24.1 cm)
- SCH8** 8" L x 5 7/8" W x 9 1/2" H  
(20.3 x 14.9 x 24.1 cm)

#### Black

- SCHB6** 6 1/4" Dia x 9 1/4" H  
(15.9 x 23.5 cm)
- SCHB7** 7 3/4" Dia x 9 1/2" H  
(19.7 x 24.1 cm)
- SCHB8** 8" L x 5 7/8" W x 9 1/2" H  
(20.3 x 14.9 x 24.1 cm)



SCH7

SCH6

SCH8



SCHB8

SCHB7

SCHB6



CRL86 shown with BHM2 S&P shakers and BEE606 shaker



FLAT-BACK DESIGN FOR PLACEMENT AGAINST A WALL



## Semi-Round Wrought Iron Condiment Racks

- CRL86** Leaf  
8 ¼" L x 6 ¼" W x 9" H  
(21 x 15.9 x 22.9 cm)
- CRS68** Scroll  
8 ¼" L x 6 ¼" W x 9" H  
(21 x 15.9 x 22.9 cm)

## Wrought Iron Condiment Racks

### Leaf Design

- LDCC16** 6 ¼" Dia. x 9" H  
(15.9 x 22.9 cm)
- LDCC17** 7 ½" Dia. x 9" H  
(19.1 x 22.9 cm)
- LDCC18** 7 ¾" Dia. x 9" H  
(19.7 x 22.9 cm)

### Scroll Design

- WBCC6** 6 ¼" Dia. x 9" H  
(15.9 x 22.9 cm)
- WBCC7** 7 ½" Dia. x 9" H  
(19.1 x 22.9 cm)
- WBCC8** 7 ¾" Dia. x 9" H  
(19.7 x 22.9 cm)

102

LDCC17 shown with BHM2 S&P shakers



LDCC18

LDCC16

WBCC6

WBCC7 shown with GLA316 shaker and BHM2 S&P shakers

WBCC8 shown with BEE606 shaker



HOT

ALL THREE DESIGNS FEATURE  
CENTER-SLOTTED HANDLES

**FWC68** shown with  
BHM2 S&P shakers



**FWC89** shown with  
3309 shaker



**FWC69**



**Flat Coil Wrought Iron  
Condiment Racks**



**FWC69** 6" Dia. x 9 1/2" H  
(15.2 x 24.1 cm)

**FWC89** 7 7/8" Dia. x 9 1/8" H  
(20 x 23.2 cm)

**FWC68** 8" L x 5 7/8" W x 9 1/4" H  
(20.3 x 14.9 x 23.5 cm)

**Birdnest Semi-Round  
Condiment Racks**



**SRBNB1** Black  
5 5/8" L x 8" W x 9 1/8" H  
(14.3 x 20.3 x 23.2 cm)

**SRBNC2** Chrome  
5 5/8" L x 8" W x 9 1/8" H  
(14.3 x 20.3 x 23.2 cm)



**SRBNB1**

**SRBNC2**





RBNC26

RBNB16



RBNB17 shown with BEE319 shaker and PNS13 S&P shakers

RBNC27

### Birdnest Condiment Racks

#### Small

**RBNB16** Black  
6" Dia. x 9 1/8" H  
(15.2 x 23.2 cm)

**RBNC26** Chrome  
6" Dia. x 9 1/8" H  
(15.2 x 23.2 cm)

#### Large

**RBNB17** Black  
7 3/4" Dia. x 9 1/8" H  
(19.7 x 23.2 cm)

**RBNC27** Chrome  
7 3/4" Dia. x 9 1/8" H  
(19.7 x 23.2 cm)



WSPR2B

WSPR3C shown with PNS24 S&P shakers

### Salt & Pepper Racks

In black or chrome, each rack features a slot on top to hold order numbers or menus.

**WSPR2B** Black  
5 3/4" L x 2 1/4" W x 12" H  
(14.6 x 5.7 x 30.5 cm)

**WSPR3C** Chrome  
5 3/4" L x 2 1/4" W x 12" H  
(14.6 x 5.7 x 30.5 cm)

### Rectangular Shopping Baskets

Keep condiments and napkins handy with these charming double-handed baskets.

**RBHB975** Black  
9" L x 7" W x 5" H  
(22.9 x 17.8 x 12.7 cm)

**RBHC759** Chrome  
9" L x 7" W x 5" H  
(22.9 x 17.8 x 12.7 cm)



### Rectangular Condiment Racks

Though we designed them for condiments, these racks double as stages for sandwiches.

**BWC9** 9" L x 6" W x 3 1/2" H  
(22.9 x 15.2 x 8.9 cm)

**BWC12** 12 3/4" L x 4 3/8" W x 3 1/2" H  
(32.4 x 11.1 x 8.9 cm)



GJ24 SQUARE  
JARS ON PG.65  
FIT JUST RIGHT

### Galvanized Condiment Caddy

We made these metallic caddies extra deep to make topper-proof transport a cinch.

**MTUB7** 7" L x 5 3/4" W x 4" H  
(17.8 x 14.6 x 10.2 cm)



COMPLETE THE LOOK WITH OUR  
GALVANIZED TUBS ON PG. 80





### Glass Carafes

With smaller sizes for individual servings of beverages or soups, and larger sizes for shared drinks, these elegantly curved carafes are a stylish addition to any brunch or dinner service.

#### Multi-Serving

- GC36** 36 oz., 34 oz. to Shoulder (1.1 L, 1 L)  
4" Dia. x 9 1/2" H (10.2 x 24.1 cm)
- GC34** 34 oz., 16 oz. to Shoulder (1 L, 473.2 mL)  
4" Dia. x 9 1/2" H (10.2 x 24.1 cm)

#### Single-Serving

- GC12** 12 oz., 10.5 oz. to Shoulder (354.9 mL, 310.5 mL)  
3 1/4" Dia. x 4 3/4" H (8.2 x 12 cm)
- GC8** 8 oz., 3 oz. to Shoulder (236.6 mL, 88.7 mL)  
3" Dia. x 4 3/4" H (7.6 x 12 cm)

### Glass Water Bottles and Stoppers

In-house water filtration is in, and these elegant pieces are the perfect accompaniment to the trend. Mix and match two styles of carafes and three styles of stoppers to elevate your H<sub>2</sub>O. Stopper sold separately.

#### Glass Water Bottles

- GCD28** Diamond  
29 oz., 28 oz. to Shoulder (0.9 L, 0.8 L)  
3 1/8" Dia. x 10 1/4" H (7.9 x 26 cm)
- GCH28** Pebbled  
29 oz., 28 oz. to Shoulder (0.9 L, 0.8 L)  
3 1/8" Dia. x 10 1/4" H (7.9 x 26 cm)

#### Glass and Silicone Bottle Stoppers

- GSB2** Blue Marble  
1 3/4" Dia. x 2 3/4" H (4.4 x 7 cm)
- GSC2** Clear  
1 3/4" Dia. x 2 3/4" H (4.4 x 7 cm)
- GSF2** Frosted  
1 3/4" Dia. x 2 3/4" H (4.4 x 7 cm)



## Hinged Acrylic Water Bottles

Our original take on a popular style, these gasketed bottles are designed to keep out contaminants.

**WBC34** 34 oz. (1 L)  
4 1/8" Dia. x 11 5/8" H (10.5 x 29.5 cm)

**WBC36** 36 oz. (1.1 L)  
3 3/8" Dia. x 11 1/8" H (8.6 x 28.3 cm)

## Clear Acrylic Water Bottles

In a quartet of distinct styles, these one-liter acrylic bottles make even simple beverages photogenic. Cap included.

**WB32** Clear  
34 oz. (1 L)  
3 1/2" Dia. x 11 1/4" H (8.9 x 28.6 cm)

**WB33** Fluted  
34 oz. (1 L)  
3 1/2" Dia. x 11 1/4" H (8.9 x 28.6 cm)

**WB34** Pebbled  
34 oz. (1 L)  
3 1/2" Dia. x 11 1/4" H (8.9 x 28.6 cm)

**WB35** Diamond  
34 oz. (1 L)  
3 1/2" Dia. x 11 1/4" H (8.9 x 28.6 cm)

**WBCAP** Replacement Cap  
1 5/8" Dia. x 1" H (4.1 x 2.5 cm)



TURN CLEAR ACRYLIC WATER BOTTLES INTO A JUMBO MIXER BOTTLE WITH A STAINLESS STEEL POURER ON PG. 348 OR A SALAD DRESSING POURER ON PG. 158







**Pebbled Acrylic Water Bottle**  

Inspired by our pebbled glass water bottle, this piece is made from plastic for extra durability. Cap included.

**WBP34** 34 oz. (1 L)  
3 7/8" Dia. x 11 5/8" H  
(8.9 x 29.5 cm)

**WBPCAP** Replacement Cap  
2 1/4" Dia. x 5/8" H  
(5.7 x 1.6 cm)

**Clear Acrylic Water Carafes with Cup**  

Durable and designed with ease in mind, these cup-carafe combos are crafted for daily use.

**WC40** 40 oz. (1.2 L)  
3 1/2" Dia. x 10" H  
(8.9 x 25.4 cm)





### Bell Pitchers

Available in stainless steel mirror finish.

#### Stainless Steel

- WP68** 68 oz. (2 L)  
5" Dia. x 8 1/4" H  
8 1/4" W with Handle  
(12.7 x 21, 21 cm)
- WP100** 100 oz. (3 L)  
5 1/4" Dia. x 9" H  
9 3/4" W with Handle  
(13.3 x 22.9, 24.8 cm)
- BPG67** 68 oz. (2 L)  
5" Dia. x 8 1/2" H  
8 1/4" W with Handle  
(12.7 x 21.6, 21 cm)  
Includes Ice Guard
- BPG101** 100 oz. (3 L)  
5" Dia. x 9 1/4" H  
9 3/4" W with Handle  
(12.7 x 23.5, 24.8 cm)  
Includes Ice Guard







DWP64

SDWP64

### Long Neck Bell Pitchers

Available in a hammered or brushed stainless steel finish.

#### Single-Wall

**BWP84** Satin Finish  
84 oz. (2.5 L)  
5" Dia. x 9 1/4" H, 8 3/4" W with Handle  
(12.7 x 23.5, 22.2 cm)  
(Not Shown, Includes Ice Guard)

**BWPH84** Hammered Finish  
84 oz. (2.5 L)  
5" Dia. x 9 1/4" H, 8 3/4" W with Handle  
(12.7 x 23.5, 22.2 cm)  
(Not Shown, Includes Ice Guard)

#### Double-Wall

**SDWP64** Satin Finish  
64 oz. (1.9 L)  
5" Dia. x 10 3/4" H, 8 3/4" W with Handle  
(12.7 x 27.3, 22.2 cm)

**DWP64** Hammered Finish  
64 oz. (1.9 L)  
5" Dia. x 10 3/4" H, 8 3/4" W with Handle  
(12.7 x 27.3, 22.2 cm)

### Gold Long Neck Bell Pitchers

Featuring beautiful hammered and satin finishes, these gold pitchers are très fashionable.

#### Single-Wall

**BWPG84** Satin Finish  
84 oz. (2.5 L)  
5" Dia. x 9 1/4" H, 8 3/4" W with Handle  
(12.7 x 23.5, 22.2 cm)

**BWPHG84** Hammered Finish  
84 oz. (2.5 L)  
5" Dia. x 9 1/4" H, 8 3/4" W with Handle  
(12.7 x 23.5, 22.2 cm)



BWPHG84

BWPG84



### Double-Wall Bell Pitchers

These double-walled pitchers are cleverly crafted to reduce condensation and drippage.

#### Mirror Finish

**DWP44** 44 oz. (1.3 L)  
4 ½" Dia. x 8 ⅛" H, 8 ½" W with Handle  
(11.4 x 20.6, 21.6 cm)

**DWP64** 64 oz. (1.9 L)  
5" Dia. x 9" H, 10" W with Handle  
(12.7 x 22.9, 25.4 cm)  
(not shown)

#### Hammered Finish

**HMWP44** 44 oz. (1.3 L)  
4 ½" Dia. x 8 ⅛" H, 8 ½" W with Handle  
(11.4 x 20.6, 21.6 cm)

**HMWP64** 64 oz. (1.9 L)  
5" Dia. x 9" H, 10" W with Handle  
(12.7 x 22.9, 25.4 cm)  
(not shown)

#### Satin Finish

**DWPS44** 44 oz. (1.3 L)  
4 ½" Dia. x 8 ⅛" H, 8 ½" W with Handle  
(11.4 x 20.6, 21.6 cm)

**DWPS64** 64 oz. (1.9 L)  
5" Dia. x 9" H, 10" W with Handle  
(12.7 x 22.9, 25.4 cm)  
(not shown)



### Hammered Bell Water Pitchers

Add a touch of artistry to your cold beverage service with these hammered stainless steel pitchers. Perfect for water, iced tea or lemonade.

**HMWP85** 68 oz. (2 L)  
5" Dia. x 8 ¼" H, 8 ¼" W with Handle  
(12.7 x 21, 21 cm)

**HMWP97** 100 oz. (3 L)  
6" Dia. x 9" H, 9 ¾" W with Handle  
(15.2 x 22.9, 24.8 cm)





**OWPIT54**

### Angled Water Pitchers

Stylishly sleek, these satin-finished stainless steel pitchers are simple, elegant and practical.

**OWPIT54** 54 oz. (1.6 L)  
4 ½" Dia. x 11" H, 6 ¼" W with Handle  
(11.4 x 27.9, 15.9 cm)

### Double-Wall Pitcher with Lid

Durable stainless steel pitcher features double-wall styling and hinged lid.

**DWCP48** 52 oz. (1.5 L)  
4 ½" Dia. x 9" H, 6 ¼" W with Handle  
(10.8 x 22.9, 15.9 cm)



HINGED LID

**DWCP48**

## Contemporary Pitchers

Our most modern pitchers, these stainless steel pieces feature slim design and ice guards for a brilliant blend of functionality and style.

**WPSF33** 33 oz. (1 L)  
3 1/8" Dia. x 8 7/8" H, 5 3/8" W with Handle  
(7.9 x 22.5, 13.7 cm)

**WPSF67** 67 oz. (2 L)  
4 1/2" Dia. x 9 1/4" H, 6 3/4" W with Handle  
(11.4 x 23.5, 17.1 cm)

WPSF67

WPSF33



## Elegance™ Double-Wall Beverage Service

Style via consistency. This five-piece stainless steel line includes coffee pots in two sizes, a water pitcher, a sugar bowl and a creamer.

**DWS5** Sugar Bowl  
5 oz. (147.9 mL)  
3 1/4" Dia. x 3" H  
(8.3 x 7.6 cm)

**DWC5** Creamer  
5 oz. (147.9 mL)  
3 1/2" L x 2" W x 5" H  
(8.9 x 5.1 x 12.7 cm)

**DWCP16** Coffee Pot  
16 oz. (473.2 mL)  
3" L x 5 1/4" W x 7 1/4" H  
(7.6 x 13.3 x 18.4 cm)

**DWWP50** Water Pitcher  
50 oz. (1.5 L)  
4 3/8" L x 7" W x 8" H  
(11.1 x 17.8 x 20.3 cm)

**DWCP50** Coffee Pot  
50 oz. (1.5 L)  
4 3/8" L x 7" W x 10" H  
(11.1 x 17.8 x 25.4 cm)



DWWP50

DWCP50

DWCP16

DWS5

DWC5





### Porcelain Creamers

These simple, round creamers bring a friendly touch to coffee service.

**PCR25** 2 ½ oz. (73.9 mL)  
2 ½" L x 3 ¼" W x 2 ¾" H  
(6.4 x 8.3 x 6 cm)

**PCR55** 5 ½ oz. (162.7 mL)  
3" L x 4 ¾" W x 3" H  
(7.6 x 11.1 x 7.6 cm)

### Porcelain Bell Creamers

A quintessential design that's sure to invoke nostalgia.

**PBC25** 2 oz. (59.1 mL)  
2 ½" L x 3" W x 3" H  
(5.4 x 7.6 x 7.6 cm)

**PBC45** 4 oz. (118.3 mL)  
3 ¼" L x 2 ¼" W x 3 ¼" H  
(8.3 x 5.7 x 8.3 cm)



### Ceramic Milk Carton Creamer

A surprising spin on a cafeteria classic, this design is a customer favorite.

**CMCC5** 5 oz. (147.9 mL)  
2 ½" L x 4 ½" W x 3 ¼" H  
(5.4 x 10.5 x 8.3 cm)



## Black Artisanal Porcelain

With a rustic two-tone glazed finish, our black collection brings a handcrafted look to coffee and dinner service alike.

<b>PBBL2</b>	<p>Creamer 2 ½ oz. (73.9 mL) 2 ½" L x 3 ¼" W x 2 ¾" H (6.3 x 8.3 x 6 cm)</p>
<b>PBBL4</b>	<p>Creamer 4 oz. (118.3 mL) 3 ¼" L x 2 ¼" W x 2 ¼" H (8.3 x 5.7 x 5.7 cm)</p>
<b>PBL7</b>	<p>Bowl 7 oz. (207 mL) 3 ⅞" Dia. x 2 ¼" H (9.8 x 5.7 cm)</p>
<b>PSBL</b>	<p>Sugar Packet Holder 5 oz. (147.9 mL) 3 ½" L x 2 ½" W x 2" H (8.9 x 6.3 x 5.1 cm)</p>



## The Swan Collection

Just like an elegant swan's neck, this pair of glass sugar holder and creamer adds a touch of class to every table. The clear curvature of the design allows for easy serving and pouring. Pair with a stainless steel or acacia wood caddy to complete the look.

<b>GC4</b>	<p>Glass Creamer 4 oz. (118.3 mL) 1 ¾" Dia. x 4 ⅜" H (4.4 x 11.1 cm)</p>
<b>GS4</b>	<p>Glass Sugar Holder 4 oz. (118.3 mL) 1 ¾" Dia. x 4 ⅜" H (4.4 x 11.1 cm)</p>
<b>CADDYW2</b>	<p>Acacia Wood Caddy 6 ⅞" L x 3 ½" W x 6 ¾" H (17.5 x 8.9 x 17.1 cm)</p>
<b>CADDYSS2</b>	<p>Stainless Steel Caddy 6 ⅞" L x 3 ½" W x 6 ¾" H (16.8 x 8.9 x 17.1 cm)</p>



FITS 6 OZ. CONTEMPORARY  
GLASS SHAKERS ON PG. 146





## Evolution™ Creamers

### Silver

- SCM3** 2 ½ oz. (73.9 mL)  
2" Dia. x 2" H (5.1 x 5.1 cm)
- SCM4** 4 ½ oz. (133.1 mL)  
2" Dia. x 3 ½" H (5.1 x 8.9 cm)
- SCM6** 6 oz. (177.4 mL)  
2" Dia. x 4 ¾" H (5.1 x 12.1 cm)

### Crimped NEW

- SCMC3** 2 ½ oz. (73.9 mL)  
2" Dia. x 2" H (5.1 x 5.1 cm)
- SCMC4** 4 ½ oz. (133.1 mL)  
2" Dia. x 3 ½" H (5.1 x 8.9 cm)
- SCMC6** 6 oz. (177.4 mL)  
2" Dia. x 4 ¾" H (5.1 x 12.1 cm)

### Black

- SCMB3** 2 ½ oz. (73.9 mL)  
2" Dia. x 2" H (5.1 x 5.1 cm)
- SCMB4** 4 ½ oz. (133.1 mL)  
2" Dia. x 3 ½" H (5.1 x 8.9 cm)
- SCMB6** 6 oz. (177.4 mL)  
2" Dia. x 4 ¾" H (5.1 x 12.1 cm)

### Gold

- SCMG3** 2 ½ oz. (73.9 mL)  
2" Dia. x 2" H (5.1 x 5.1 cm)
- SCMG4** 4 ½ oz. (133.1 mL)  
2" Dia. x 3 ½" H (5.1 x 8.9 cm)
- SCMG6** 6 oz. (177.4 mL)  
2" Dia. x 4 ¾" H (5.1 x 12.1 cm)

## Hammered Bell Creamers

Just try and resist these adorable creamers in copper, gold or natural stainless steel. Your customers will be charmed by their sleek hammered design and petite frame.

### Copper 🔹

- CHC2** 2 oz. (59.1 mL)  
2 ¼" L x 2" W x 2 ¼" H  
(5.7 x 5.1 x 5.7 cm)
- CHC4** 4 oz. (118.3 mL)  
3" L x 2 ¼" W x 2 ¾" H  
(7.6 x 5.7 x 7 cm)

### Gold 🔹

- CHG2** 2 oz. (59.1 mL)  
2 ¼" L x 2" W x 2 ¼" H  
(5.7 x 5.1 x 5.7 cm)
- CHG4** 4 oz. (118.3 mL)  
3" L x 2 ¼" W x 2 ¾" H  
(7.6 x 5.7 x 7 cm)

### Silver

- CHS2** 2 oz. (59.1 mL)  
2 ¼" L x 2" W x 2 ¼" H  
(5.7 x 5.1 x 5.7 cm)
- CHS4** 4 oz. (118.3 mL),  
3" L x 2 ¼" W x 2 ¾" H  
(7.6 x 5.7 x 7 cm)

## Milk Carton Creamers

### Silver

**MCC300** 3 oz. (88.7 mL)  
2 3/4" L x 2" W x 2 1/4" H (7 x 5.1 x 5.7 cm)

**MCC500** 5 oz. (147.9 mL)  
2 3/4" L x 2" W x 3" H (7 x 5.1 x 7.6 cm)

### Gold

**MCG300** 3 oz. (88.7 mL)  
2 3/4" L x 2" W x 2 1/4" H (7 x 5.1 x 5.7 cm)

**MCG500** 5 oz. (147.9 mL)  
2 3/4" L x 2" W x 3" H (7 x 5.1 x 7.6 cm)

### Black

**MCB300** 3 oz. (88.7 mL)  
2 3/4" L x 2" W x 2 1/4" H (7 x 5.1 x 5.7 cm)

**MCB500** 5 oz. (147.9 mL)  
2 3/4" L x 2" W x 3" H (7 x 5.1 x 7.6 cm)



PAIR THESE WITH MATCHING PIECES ON PG. 122





HOT



SSPT5

SSBV1

Shown with ST10 stainless steel tray

MCC500

SSPH2

SCM2

SSPT3

SSPH4

SSPT3



HOT

RSSPH2

SQSSPH2

SSPT3

RTSSPH3

### Satin Finish Stainless Coffee/ Tabletop Accessories HOT

#### Straight-Sided Sugar Packet/Cube Holders

- SSPH2 2" Dia. x 2 3/4" H (5.1 x 7 cm)
- SSPT5 2" Sq. x 2 3/4" H (5.1 x 7 cm)
- SSPH4 3 1/4" L x 2 3/4" W x 1 3/4" H (8.3 x 7 x 4.4 cm)

#### Angled Sugar Packet/Cube Holders

- RSSPH2 2" Dia. x 2 3/4" H (5.1 x 7 cm)
- SQSSPH2 2" Sq. x 2 3/4" H (5.1 x 7 cm)
- RTSSPH3 3 1/8" L x 2 1/2" W x 1 3/4" H (7.9 x 6.4 x 4.4 cm)

#### Tray

- SSPT3 4 1/4" L x 2 1/4" W x 1" H (10.8 x 5.7 x 2.5 cm)

#### Bud Vase

- SSBV1 1 3/4" Sq. x 5 1/4" H (4.4 x 13.3 cm)

#### Creamers

- SCM2 4 oz. (118.3 mL)  
2" Dia. x 2 3/4" H (5.1 x 7 cm)
- MCC500 5 oz. (147.9 mL)  
2 3/4" L x 2" W x 3" H (7 x 5.1 x 7.6 cm)



## Hammered Finish Stainless Coffee/ Tabletop Accessories

### Angled Sugar Packet/Cube Holders

**HMSRSPH2** 2" Dia. x 2 ¾" H (5.1 x 7 cm)

**HMSSQPH2** 2" Sq. x 2 ¾" H (5.1 x 7 cm)

**HMSRSPH3** 3 ½" L x 2 ½" W x 1 ¾" H (7.9 x 6.6 x 4.5 cm)

### Straight-Sided Sugar Packet/Cube Holders

**HMSPH2** 2" Dia. x 2 ¾" H (5.1 x 7 cm)

**HMSPT5** 2" Sq. x 2 ¾" H (5.1 x 7 cm)

**HMSPH4** 3 ¼" L x 2 ¾" W x 1 ¾" H (8.3 x 7 x 4.4 cm)

### Tray

**HMSPT3** 4 ¼" L x 2 ¼" W x 1" H (10.8 x 5.7 x 2.5 cm)

### Bud Vase

**HMBV1** 1 ¾" Sq. x 5 ¼" H (4.4 x 13.3 cm)

### Creamer

**HMCM2** 4 oz. (118.3 mL)  
2" Dia. x 2 ¾" H (5.1 x 7 cm)







## Stainless Steel Coffee Accessories

Contemporary, luxe and undeniably striking, this collection of tabletop accessories draws attention with cosmopolitan flair. Dishwasher-safe finish. Color may vary slightly.

### Black

- BSPH2** Cylinder  
2" Dia. x 2 3/4" H  
(5.1 x 7 cm)
- BPT3** Tray  
4 1/4" L x 2 1/4" W x 1" H  
(10.8 x 5.7 x 2.5 cm)
- BSPT5** Square  
2" Sq. x 2 3/4" H  
(5.1 x 7 cm)
- BCM2** Creamer  
4 oz. (118.3 mL)  
2" Dia. x 2 3/4" H  
(5.1 x 5.1 x 7 cm)
- BSPH4** Rectangular  
3 1/4" L x 2 3/4" W x 1 3/4" H  
(8.3 x 7 x 4.4 cm)



### Gold

- GSPH2** Cylinder  
2" Dia. x 2 3/4" H  
(5.1 x 7 cm)
- GPT3** Tray  
4 1/4" L x 2 1/4" W x 1" H  
(10.8 x 5.7 x 2.5 cm)
- GSPH4** Rectangular  
3 1/4" L x 2 3/4" W x 1 3/4" H  
(8.3 x 7 x 4.4 cm)
- GSPT5** Square  
2" Sq. x 2 3/4" H  
(5.1 x 7 cm)
- GCM2** Creamer  
4 oz. (118.3 mL)  
2" Dia. x 2 3/4" H  
(5.1 x 7 cm)



## Hammered Aluminum Sugar Packet Holders

In your choice of super sleek colors, these aluminum sugar packet holders are sure to sweeten your coffee and tea presentation.

- ASPC** Copper  
6 oz. (177.4 mL)  
3 3/8" L x 2 3/8" W x 2" H  
(8.6 x 6 x 5.1 cm)
- ASPB** Black  
6 oz. (177.4 mL)  
3 3/8" L x 2 3/8" W x 2" H  
(8.6 x 6 x 5.1 cm)
- ASPS** Silver  
6 oz. (177.4 mL)  
3 3/8" L x 2 3/8" W x 2" H  
(8.6 x 6 x 5.1 cm)
- ASPG** Gold  
6 oz. (177.4 mL)  
3 3/8" L x 2 3/8" W x 2" H  
(8.6 x 6 x 5.1 cm)

### Stainless Steel Sugar Packet Milk Crates

- SPC2** Cylinder  
2" Dia. x 2 ¾" H  
(5.1 x 6.9 cm)
- SPC3** Rectangular  
3 ½" L x 2 ½" W x 1 ½" H  
(8.9 x 6.4 x 3.8 cm)

### Stainless Steel Sugar Packet Crates

- SPC** Satin  
3 ½" L x 2 ½" W x 1 ½" H  
(8.9 x 6.4 x 3.8 cm)
- SPH** Hammered  
3 ½" L x 2 ½" W x 1 ½" H  
(8.9 x 6.4 x 3.8 cm)

### Galvanized Sugar Packet Holders

- GSP35** Silver  
5" L x 3" W x 2" H, 6 ½" L with Handles  
(12.7 x 7.6 x 5.1, 16.5 cm)
- DGSP35** Black  
5" L x 3" W x 2" H, 6 ½" L with Handles  
(12.7 x 7.6 x 5.1, 16.5 cm)

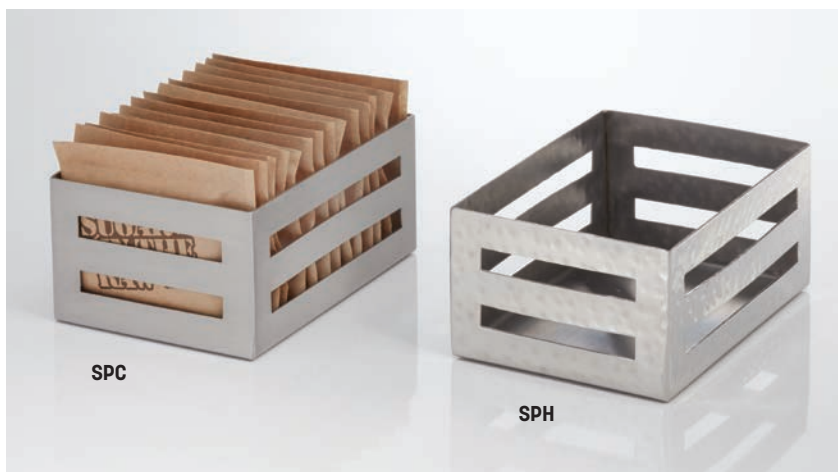





SPP326

### Ceramic Sugar Packet Holder

**SPP326** 3 1/2" L x 2 1/2" W x 2" H  
(8.9 x 6.4 x 5.1 cm)

### Porcelain Sugar Packet Holders

**PSPH3** 3 1/4" L x 2 1/2" W x 1 7/8" H  
(8.3 x 6.4 x 4.8 cm)

**PSPH4** 4" L x 2 1/4" W x 1 3/4" H  
(10.2 x 5.7 x 4.4 cm)

### Wrought Iron Sugar Packet Baskets



**SBL353** Leaf  
3 3/4" L x 2 3/4" W x 2 1/2" H  
(9.5 x 7 x 6.4 cm)

**SBS533** Scroll  
3 3/4" L x 2 3/4" W x 2 1/2" H  
(9.5 x 7 x 6.4 cm)

### Birdnest Sugar Packet Baskets



**BNSB3** Black  
4 1/2" L x 2 1/4" W x 1 3/4" H  
(11.4 x 5.7 x 4.4 cm)

**BNSC3** Chrome  
4 1/2" L x 2 1/4" W x 1 3/4" H  
(11.4 x 5.7 x 4.4 cm)



PSPH4

PSPH3



SBS533

SBL353



BNSC3

BNSB3

**Stainless Steel Swing Waste Bins** HOT

- TIM1** 4 ¾" Dia. x 6 ⅝" H  
(12.1 x 16.8 cm)
- TIM2** 4 ¾" Dia. x 9" H  
(12.1 x 22.9 cm)



**Stainless Steel Mini Trash Cans**

- OSCAR** Can  
3 ¾" Dia. x 3 ½" H  
(9.5 x 8.9 cm)
- OLID** Lid for OSCAR  
3 ¾" Dia. x 1 ½" H  
(9.5 x 3.8 cm)
- OSCAR2** Can  
5" Dia. x 4 ⅞" H  
(12.7 x 12.4 cm)
- OLID2** Lid for OSCAR2  
5" Dia. x 1 ⅝" H  
(12.7 x 4.1 cm)
- OSCAR3** Can  
6" Dia. x 5 ⅞" H  
(15.2 x 14.9 cm)
- OLID3** Lid for OSCAR3  
6" Dia. x 1 ⅞" H  
(15.2 x 4.8 cm)

**Sugar and Ice Tongs**

- IT400** Sugar Tongs  
4" L (10.2 cm)
- IT700** Hammered Ice Tongs  
6 ½" L (16.5 cm)







BNCB84

BNCC48

## Birdnest Coffee Caddies 🔹

- BNCB84** Black  
8 1/2" L x 4 3/8" W x 3 1/8" H  
(21.6 x 11.1 x 7.9 cm)
- BNCC48** Chrome  
8 1/2" L x 4 3/8" W x 3 1/8" H  
(21.6 x 11.1 x 7.9 cm)

## Stainless Steel Coffee Caddies

- BAR55** Satin  
8" L x 4" W x 4 1/8" H  
(20.3 x 10.2 x 10.5 cm)
- HMBAR9** Hammered  
8" L x 4" W x 4 1/8" H  
(20.3 x 10.2 x 10.5 cm)

## Metal Caddies 🔹

Our most versatile bar caddies yet, this pair of stylishly functional pieces are perfect for just about any bar setting.

### Antique Copper

- BARC5** Coffee Caddy  
8" L x 4" W x 4 1/8" H  
(20.3 x 10.2 x 10.5 cm)
- BARC7** Bar Caddy  
9 1/8" L x 5 7/8" W x 4 1/8" H  
(23.2 x 14.9 x 10.5 cm)

### Black

- BARB5** Coffee Caddy  
8" L x 4" W x 4 1/8" H  
(20.3 x 10.2 x 10.5 cm)
- BARB7** Bar Caddy  
9 1/8" L x 5 7/8" W x 4 1/8" H  
(23.2 x 14.9 x 10.5 cm)

### Gold NEW

- BARG5** Coffee Caddy  
8" L x 4" W x 4 1/8" H  
(20.3 x 10.2 x 10.5 cm)
- BARG7** Bar Caddy  
9 1/8" L x 5 7/8" W x 4 1/8" H  
(23.2 x 14.9 x 10.5 cm)



BAR55

HMBAR9



BARC7

BARC5



BARB7

BARB5



BARG7

BARG5

NEW





Shown with GLADT6 glass shaker, PNS24 glass S&P set and MSTNG5 stainless steel tongs

PRODUCTS PWBB45 AND PWBB3 STACK FOR SIMPLE STORAGE

PWBC8

PWBS4

PWBC7

PWBB45

PWBB3



PWC8

PWC7

PWS4

PWB45

PWB3

### Poplar Wood Caddies

This five-piece collection provides function and stylish coordination. Choose from rustic natural wood or sleek black.

#### Black

**PWBS4** 4" L x 3 5/8" W x 1 5/8" H  
(10.2 x 9.2 x 4 cm)

**PWBB3** 3 5/8" L x 3 7/8" W x 3 1/2" H  
(9.2 x 9.8 x 9 cm)

**PWBB45** 4 5/8" L x 5" W x 3 3/4" H  
(11.7 x 12.7 x 9.5 cm)

**PWBC7** 7 1/2" L x 6 1/2" W x 5 1/8" H  
(19.1 x 16.5 x 13 cm)

**PWBC8** 6 5/8" L x 6 1/2" W x 7 1/4" H  
(16.8 x 16.5 x 18.4 cm)

#### Natural

**PWS4** 4" L x 3 5/8" W x 1 5/8" H  
(10.2 x 9.2 x 4 cm)

**PWB3** 3 5/8" L x 3 7/8" W x 3 1/2" H  
(9.2 x 9.8 x 9 cm)

**PWB45** 4 5/8" L x 5" W x 3 3/4" H  
(11.7 x 12.7 x 9.5 cm)

**PWC7** 7 1/2" L x 6 1/2" W x 5 1/8" H  
(19.1 x 16.5 x 13 cm)

**PWC8** 6 5/8" L x 6 1/2" W x 7 1/4" H  
(16.8 x 16.5 x 18.4 cm)



## Wood Caddies

Our crates in vintage, bamboo and black wood are so popular that we have expanded into matching caddies.

### Vintage

**WCV4** 3 7/8" Sq. x 4 3/4" H  
(9.8 x 12.1 cm)

**WCV7** 7 1/2" L x 6 1/4" W x 4 3/4" H  
(19.1 x 15.9 x 12.1 cm)

### Bamboo

**WCBA4** 3 7/8" Sq. x 4 3/4" H  
(9.8 x 12.1 cm)

**WCBA7** 7 1/2" L x 6 1/4" W x 4 3/4" H  
(19.1 x 15.9 x 12.1 cm)

### Black

**WCBL4** 3 7/8" Sq. x 4 3/4" H  
(9.8 x 12.1 cm)

**WCBL7** 7 1/2" L x 6 1/4" W x 4 3/4" H  
(19.1 x 15.9 x 12.1 cm)

PERFECT FOR COFFEE STATIONS







### Porcelain Sauce Cups

**PCG2** Gray  
2 oz. (59.1 mL)  
2" Dia. x 1 1/2" H (5.1 x 3.8 cm)

**PCWH2** White  
2 oz. (59.1 mL)  
2" Dia. x 1 1/2" H (5.1 x 3.8 cm)

### Porcelain Three-Compartment Sauce Dish

Try serving sauces, tiny desserts, hors d'oeuvres and more in this elegant, low-profile triptych.

**PORSD3R** 1 1/2 oz. (44.4 mL)  
5 3/4" L x 3 1/8" W x 1" H  
(14.6 x 7.9 x 2.5 cm)

### Mini Ceramic Fry Pan

The pouring spout and handle on this petite piece make it exceptionally versatile.

**CFP4** 4 oz. (118.3 mL)  
3 1/2" Dia. x 1 1/2" H  
5 1/8" W with Handle  
(13 x 8.9 x 3.8, 13 cm)





### Round and Porcelain Sauce Cups

Originally designed for sauces, these beauties also set the stage for salts, oils, condiments and more.

- PRSD3** 1½ oz. (44.4 mL)  
3" Dia. x ¾" H (7.6 x 1.9 cm)
- PSLT17** ½ oz. (14.8 mL)  
1¾" Dia. x ¾" H (4.4 x 1.9 cm)
- PSLT2** 1 oz. (29.6 mL)  
2 ⅛" Dia. x 1" H (5.4 x 2.5 cm)

### Squavy™ Porcelain Sauce Cups

- SQVY1** 1½ oz. (44.4 mL)  
2 ¼" Dia. x 1½" H (5.7 x 3.8 cm)
- SQVY2** 2½ oz. (73.9 mL)  
2 ½" Dia. x 1 ⅝" H (6.4 x 4.1 cm)
- SQVY3** 5 oz. (147.9 mL)  
3 ½" Dia. x 1 ⅞" H (8.9 x 4.8 cm)
- SQVY4** 15 oz. (443.6 mL)  
4 ½" Dia. x 2 ½" H (11.4 x 6.6 cm)

### Squound™ Ceramic Sauce Cups

- SQSC15** 1½ oz. (44.4 mL)  
2 ¾" Dia. x 1" H (7 x 2.5 cm)
- SQSC20** 2 oz. (59.1 mL)  
3" Dia. x 1" H (7.6 x 2.5 cm)
- SQSC30** 3 oz. (88.7 mL)  
3 ½" Dia. x 1 ¼" H (8.9 x 3.2 cm)
- SQSC40** 4 oz. (118.3 mL)  
4" Dia. x 1 ½" H (10.2 x 3.8 cm)







### Ceramekins™

- CRMK2** 2 oz. (59.1 mL)  
2 ¾" Dia. x 1 ¼" H (7 x 3.2 cm)
- CRMK4** 4 oz. (118.3 mL)  
3 ½" Dia. x 1 ⅝" H (8.9 x 4.1 cm)
- CRMK6** 6 oz. (177.4 mL)  
3 ⅝" Dia. x 1 ⅝" H (9.5 x 4.1 cm)

### Square Porcelain Sauce Cups

When a culinary experience consists of a single bite, these porcelain cups are the perfect solution.

- CSC15** 1 ½ oz. (44.4 mL)  
1" Sq. x 1 ⅝" H (2.5 x 2.9 cm)
- CSC20** 2 oz. (59.1 mL)  
2 ½" Sq. x 1 ⅜" H (6.4 x 3.5 cm)
- PORD39** 2 oz. (59.1 mL)  
3" Sq. x 1" H (7.6 x 2.5 cm)
- PORB29** 4 oz. (118.3 mL)  
3" Sq. x 2" H (7.6 x 5.1 cm)
- PORB30** 5 ½ oz. (162.7 mL)  
3 ¼" Sq. x 2 ¼" H (8.3 x 5.7 cm)





**Flared Stainless Steel Sauce Cups**

- FT15** 2 oz. (59.1 mL)  
2 5/8" Dia. x 1 1/4" H (6.7 x 3.2 cm)
- FT25** 3 oz. (88.7 mL)  
3" Dia. x 1 1/2" H (7.6 x 3.8 cm)
- FT40** 4 oz. (118.3 mL)  
3 3/8" Dia. x 1 7/8" H (8.6 x 4.8 cm)

**Double-Wall Stainless Steel Sauce Cup**

- DWSC7** 7 oz. (207 mL)  
3 3/8" Dia. x 2 5/8" H (8.6 x 6.7 cm)

**Ribbed Stainless Steel Sauce Cups**

- RSC3** 1 1/2 oz. (44.4 mL)  
2 1/2" Dia. x 1" H (6.4 x 2.5 cm)
- RSC1** 2 1/2 oz. (73.9 mL)  
2 1/4" Dia. x 1 3/4" H (5.7 x 4.4 cm)
- RSC4** 4 oz. (118.3 mL)  
3" Dia. x 2" H (7.6 x 5.1 cm)

**Fluted Stainless Steel Sauce Cups**

- RB15** 1 1/2 oz. (44.4 mL)  
2 1/2" Dia. x 7/8" H (6.4 x 2.2 cm)
- RB25** 2 1/2 oz. (73.9 mL)  
2 3/8" Dia. x 1 5/8" H (6 x 4.1 cm)

SATIN FINISH DELIVERS  
EASY ELEGANCE





HOT

STAINLESS STEEL MAKES THIS COLLECTION SHINE



### Stainless Steel Sauce Cups HOT

- MB3** 1 ½ oz. (44.4 mL)  
2 ½" Dia. x 1" H (6.4 x 2.5 cm)
- MB1** 2 ½ oz. (73.9 mL)  
2 ¼" Dia. x 1 ¾" H (5.7 x 4.4 cm)
- MB4** 4 oz. (118.3 mL)  
3" Dia. x 2" H (7.6 x 5.1 cm)
- SSC15** 1 ½ oz. (44.4 mL)  
2 ¾" Sq. x 1" H (6 x 2.5 cm)
- D404** 1 ½ oz. (44.4 mL)  
2 ¾" L x 2" W x ½" H (7 x 5.1 x 1.3 cm)
- D405** 2 ½ oz. (73.9 mL)  
3 ⅞" L x 3" W x ⅞" H (9.8 x 7.6 x 2.2 cm)
- SSC25** 2 ½ oz. (73.9 mL)  
2 ¾" Sq. x 1 ⅜" H (6 x 3.5 cm)
- D406** 4 oz. (118.3 mL)  
4 ⅝" L x 3 ¾" W x ⅞" H (11.7 x 9.5 x 2.2 cm)
- B34** 3 ½ oz. (103.5 mL)  
3 ¼" Dia. x 1 ¼" H (8.3 x 3.2 cm)

### Large Capacity Stainless Steel Sauce Cups

- B31** Mirror Finish  
8 oz. (236.6 mL)  
3 ⅝" Dia. x 2 ¼" H (9.2 x 5.7 cm)
- BS31** Satin Finish  
8 oz. (236.6 mL)  
3 ⅝" Dia. x 2 ¼" H (9.2 x 5.7 cm)
- BH31** Hammered  
8 oz. (236.6 mL)  
3 ⅝" Dia. x 2 ¼" H (9.2 x 5.7 cm)

## Round Hammered Stainless Steel Sauce Cups HOT

Add a lustrous quality to your tabletop with gorgeous hammered stainless steel sauce cups. Available in a variety of sizes and dishwasher-safe colors. Color may vary slightly.

### Silver

<b>HAMSC3</b>	1 ½ oz. (44.4 mL) 2 ¼" Dia. x 1" H (5.7 x 2.5 cm)
<b>HAMSC</b>	2 ½ oz. (73.9 mL) 2 ¼" Dia. x 1 ¾" H (5.7 x 4.4 cm)
<b>HAMSC4</b>	4 oz. (118.3 mL) 2 ¾" Dia. x 2" H (7 x 5.1 cm)

### Black

<b>HAMSCB3</b>	1 ½ oz. (44.4 mL) 2 ¼" Dia. x 1" H (5.7 x 2.5 cm)
<b>HAMSCB</b>	2 ½ oz. (73.9 mL) 2 ¼" Dia. x 1 ¾" H (5.7 x 4.4 cm)
<b>HAMSCB4</b>	4 oz. (118.3 mL) 2 ¾" Dia. x 2" H (7 x 5.1 cm)

### Gold

<b>HAMSCG3</b>	1 ½ oz. (44.4 mL) 2 ¼" Dia. x 1" H (5.7 x 2.5 cm)
<b>HAMSCG</b>	2 ½ oz. (73.9 mL) 2 ¼" Dia. x 1 ¾" H (5.7 x 4.4 cm)
<b>HAMSCG4</b>	4 oz. (118.3 mL) 2 ¾" Dia. x 2" H (7 x 5.1 cm)

## Square Hammered Stainless Steel Sauce Cups

<b>HAMSC15</b>	1 ½ oz. (44.4 mL) 2" Sq. x 1" H (5.1 x 2.5 cm)
<b>HAMSC25</b>	2 ½ oz. (73.9 mL) 2 ¼" Sq. x 1 ¼" H (5.7 x 3.2 cm)







### Straight-Sided Satin Finish Stainless Steel Mini Bowls

- SMB3** 4 oz. (118.3 mL)  
3" Dia. x 1" H (7.6 x 2.5 cm)
- SMB4** 8 oz. (236.6 mL)  
4" Dia. x 1 1/4" H (10.2 x 3.2 cm)
- SMB5** 15 oz. (443.6 mL)  
5" Dia. x 1 1/4" H (12.7 x 3.2 cm)

### Double-Wall Stainless Steel Angled Mini Bowls

#### Satin Finish

- DWS2** 2.5 oz. (73.9 mL)  
3" Dia. x 2 3/4" H (7.6 x 7 cm)
- DWSS5** 5 oz. (147.9 mL)  
3 1/2" Dia. x 3" H (8.9 x 7.6 cm)

#### Hammered

- HDWS2** 2.5 oz. (73.9 mL)  
3" Dia. x 2 3/4" H (7.6 x 7 cm)
- HDWS5** 5 oz. (147.9 mL)  
3 1/2" Dia. x 3" H (8.9 x 7.6 cm)



### Oval Hammered Sauce Cups

These tiny oval sauce cups dress up any dish in need of an accompaniment. Available in sleek finishes and multiple sizes.

#### Stainless Steel

- HS2** 2 oz. (59.1 mL)  
2 ½" L x 2" W x 1 ¼" H  
(6.3 x 5 x 3.1 cm)
- HS3** 3 oz. (88.7 mL)  
2 ¾" L x 2" W x 1 ¼" H  
(6.9 x 5 x 3.1 cm)
- HS4** 4 oz. (118.3 mL)  
3 ¼" L x 2 ¾" W x 1 ½" H  
(8.2 x 6.9 x 3.8 cm)
- HS8** 8 oz. (236.5 mL)  
3 ¾" L x 3" W x 2" H  
(9.5 x 7.6 x 5 cm)

#### Copper

- HSC2** 2 oz. (59.1 mL)  
2 ½" L x 2" W x 1 ¼" H  
(6.3 x 5 x 3.1 cm)
- HSC3** 3 oz. (88.7 mL)  
2 ¾" L x 2" W x 1 ¼" H  
(6.9 x 5 x 3.1 cm)
- HSC4** 4 oz. (118.3 mL)  
3 ¼" L x 2 ¾" W x 1 ½" H  
(8.2 x 6.9 x 3.8 cm)
- HSC8** 8 oz. (236.5 mL)  
3 ¾" L x 3" W x 2" H  
(9.5 x 7.6 x 5 cm)







## Mini Melamine Serving Dishes BPA FREE

Let's face it. Cute sells and these mini melamine bowls and plates are the epitome of adorable! Use as a small dish to plate up small bites or to creatively serve sauces and condiments. These guys may be small, but they pack a powerful punch in versatility.

### Rectangular Plates

- MMP6** 6 5/8" L x 4 3/8" W x 7/8" H  
(16.8 x 11.1 x 2.2 cm)
- MMP8** 8 1/2" L x 5 3/4" W x 1" H  
(21.6 x 14.6 x 2.5 cm)

### Round Bowls

- MMB3** 3 oz. (88.7 mL)  
3 3/4" Dia. x 1 1/8" H  
(9.5 x 2.9 cm)
- MMB6** 6 oz. (177.4 mL)  
4 1/2" Dia. x 1 1/4" H  
(11.4 x 3.2 cm)
- MMB9** 9 oz. (266.2 mL)  
5 1/2" Dia. x 1 3/8" H  
(14 x 3.5 cm)

### Handled Bowls

- MMBH3** 3 oz. (88.7 mL)  
4" L x 3 5/8" W x 2 1/4" H  
(10.2 x 2.9 x 5.7 cm)
- MMBH7** 7 oz. (207 mL)  
4 1/4" L x 4 3/4" W x 3" H  
(10.8 x 12.1 x 7.6 cm)

### Shaped Bowls

- MMOB1** 1 1/2 oz. (44.4 mL)  
4 5/8" L x 2 5/8" W x 2 1/8" H  
(11.7 x 6.7 x 5.4 cm)
- MMOB2** 2 oz. (59.1 mL)  
4 1/4" L x 3 3/8" W x 1" H  
(10.8 x 8.6 x 2.5 cm)
- MMOB25** 2 1/2 oz. (73.9 mL)  
4 1/4" L x 2 1/2" W x 1 5/8" H  
(10.8 x 6.4 x 4.1 cm)
- MMOB3** 3 oz. (88.7 mL)  
5 1/2" L x 3" W x 1 1/4" H  
(14 x 7.6 x 3.2 cm)



## Unity Collection Sauce Cups

### Round

**USCR2GE** Graphite  
2 oz. (59.1 mL)  
2 1/2" Dia. x 1 5/8" H  
(6.4 x 4.1 cm)

**USCR2MO** Mocha  
2 oz. (59.1 mL)  
2 1/2" Dia. x 1 5/8" H  
(6.4 x 4.1 cm)

### Square

**USCS2GE** Graphite  
2 oz. (59.1 mL)  
2" Sq. x 1 5/8" H  
(5.1 x 4.1 cm)

**USCS2MO** Mocha  
2 oz. (59.1 mL)  
2" Sq. x 1 5/8" H  
(5.1 x 4.1 cm)



## Crave Collection Sauce Cups

**CSC4SH** Shadow  
4 1/2 oz. (133.1 mL)  
3 1/4" Dia. x 2" H  
(8.3 x 5.1 cm)

**CSC4CL** Cloud  
4 1/2 oz. (133.1 mL)  
3 1/4" Dia. x 2" H  
(8.3 x 5.1 cm)

**CSC4ST** Storm  
4 1/2 oz. (133.1 mL)  
3 1/4" Dia. x 2" H  
(8.3 x 5.1 cm)  
(not shown)



## Jane Collection Sauce Cups

**DSC1WH** 1 oz. (29.6 mL)  
2 3/4" Dia. x 7/8" H  
(7 x 2.2 cm)

**DSC3WH** 2 3/4 oz. (81.3 mL)  
3 1/2" Dia. x 1" H  
(8.9 x 2.5 cm)

**MSC8** 8 oz. (236.6 mL)  
3 5/8" Dia. x 2 1/8" H  
(9.2 x 5.4 cm)







MSCSB3

MSCRW2

MSCRB2

MSCSW3

STYLISHLY STACKABLE FOR PRESENTATION AND STORAGE



MELBPH

### Matte Finish Melamine Stackable Sauce Cups BPA FREE

#### Round

**MSCRB2** Black,  
2 ½ oz. (73.9 mL)  
2 ¾" Dia. x 1 ¾" H (6 x 4.5 cm)

**MSCRW2** White  
2 ½ oz. (73.9 mL)  
2 ¾" Dia. x 1 ¾" H (6 x 4.5 cm)

#### Square

**MSCSB3** Black  
3 oz. (88.7 mL)  
2 ¾" Sq. x 1 ¾" H (6 x 4.5 cm)

**MSCSW3** White  
3 oz. (88.7 mL)  
2 ¾" Sq. x 1 ¾" H (6 x 4.5 cm)

### Melamine Butter Dish BPA FREE

**MELBPH** 1 oz. (29.6 mL)  
2 ½" Dia. x 1 ⅞" H (6.4 x 2.9 cm)



CRAFTED TO BE DURABLE AND DISHWASHER-SAFE

TSCB2

### Black Triangular Bamboo Fiber Sauce Cup

**TSCB2** 2 oz. (59.1 mL)  
2 ⅝" Triangle x 1 ½" H (6.7 x 3.8 cm)

**Melamine Ramekins** **White with Smooth Sides**

<b>MRS150W</b>	1 ½ oz. (44.4 mL) 2 ¾" Dia. x 1 ½" H (6 x 3.8 cm)
<b>MRS200W</b>	2 oz. (59.1 mL) 2 7/8" Dia. x 1 ½" H (7.3 x 3.8 cm)
<b>MRS300W</b>	3 oz. (88.7 mL) 3 ¼" Dia. x 1 7/8" H (8.3 x 4.8 cm)
<b>MRS400W</b>	4 oz. (118.3 mL) 3 ¼" Dia. x 2" H (8.3 x 5.1 cm)
<b>MRS600W</b>	6 oz. (177.4 mL) 3 7/8" Dia. x 2" H (9.8 x 5.1 cm)

**Black with Smooth Sides**

<b>MRS150BL</b>	1 ½ oz. (44.4 mL) 2 ¾" Dia. x 1 ½" H (6 x 3.8 cm)
<b>MRS200BL</b>	2 oz. (59.1 mL) 2 7/8" Dia. x 1 ½" H (7.3 x 3.8 cm)
<b>MRS300BL</b>	3 oz. (88.7 mL) 3 ¼" Dia. x 1 7/8" H (8.3 x 4.8 cm)
<b>MRS400BL</b>	4 oz. (118.3 mL) 3 ¼" Dia. x 2" H (8.3 x 5.1 cm)
<b>MRS600BL</b>	6 oz. (177.4 mL) 3 7/8" Dia. x 2" H (9.8 x 5.1 cm)

**White with Fluted Sides**

<b>MRF150W</b>	1 ½ oz. (44.4 mL) 2 ½" Dia. x 1 ½" H (6.4 x 3.8 cm)
<b>MRF250W</b>	2 oz. (59.1 mL) 2 ¾" Dia. x 1 ½" H (7 x 3.8 cm)
<b>MRF350W</b>	3 oz. (88.7 mL) 3 ½" Dia. x 1 5/8" H (7.9 x 4.1 cm)
<b>MRF450W</b>	4 oz. (118.3 mL) 3 ¼" Dia. x 2" H (8.3 x 5.1 cm)

**Black with Fluted Sides**

<b>MRF150BL</b>	1 ½ oz. (44.4 mL) 2 ½" Dia. x 1 ½" H (6.4 x 3.8 cm)
<b>MRF250BL</b>	2 oz. (59.1 mL) 2 ¾" Dia. x 1 ½" H (7 x 3.8 cm)
<b>MRF350BL</b>	3 oz. (88.7 mL) 3 ½" Dia. x 1 5/8" H (7.9 x 4.1 cm)
<b>MRF450BL</b>	4 oz. (118.3 mL) 3 ¼" Dia. x 2" H (8.3 x 5.1 cm)

**Square Melamine Sauce Cups** **White**

<b>MELSC15</b>	1 oz. (29.6 mL) 2" Sq. x 1 3/8" H (5.1 x 3.5 cm)
<b>MELSC20</b>	2 oz. (59.1 mL) 2 ½" Sq. x 1 5/8" H (6.4 x 4.1 cm)

**Black**

<b>MELSCB51</b>	1 oz. (29.6 mL) 2" Sq. x 1 3/8" H (5.1 x 3.5 cm)
<b>MELSCB21</b>	2 oz. (59.1 mL) 2 ½" Sq. x 1 5/8" H (6.4 x 4.1 cm)





### Porcelain Gravy Boats

This classic design comes in three different sizes.

- GB3** 3 oz. (88.7 mL)  
6" L x 1 3/4" W x 3 1/2" H  
(15.2 x 4.5 x 8.9 cm)
- GB8** 9 oz. (266.2 mL)  
8" L x 2 3/4" W x 5" H  
(20.3 x 7 x 12.7 cm)
- GB16** 16 oz. (473.2 mL)  
9" L x 3 1/2" W x 5 1/4" H  
(22.9 x 8.9 x 13.3 cm)

### Porcelain Sauce Server

Creamer by day and gravy boat by night, this modern piece features organic curves and a unique handle-free design.

- CM4** 4 oz. (118.3 mL)  
3 3/4" L x 2 3/4" W x 2" H  
(9.5 x 7 x 5.1 cm)

### Stainless Steel Gravy Boats

Perfect for gravy or salad dressings.

- GB300** 3 oz. (88.7 mL)  
5 7/8" L x 2 5/8" W x 2 7/8" H  
(14.9 x 6.7 x 7.3 cm)
- GB500** 5 oz. (147.9 mL)  
7 1/8" L x 3" W x 2 3/4" H  
(18.1 x 7.6 x 7.9 cm)
- GB1000** 10 oz. (295.7 mL)  
8 3/4" L x 3 3/4" W x 3 1/4" H  
(22.2 x 9.5 x 8.3 cm)
- GB1600** 16 oz. (473.2 mL)  
9 1/4" L x 4 3/4" W x 4 3/4" H  
(23.5 x 12.1 x 12.1 cm)

### Stainless Steel Bell Creamers/Syrup Servers

Stainless steel with mirror finish.

- CP150** NEW 1 ½ oz. (44.4 mL)  
1 ¾" Dia. x 2" H, 2 ¾" W with Handle  
(4.4 x 5.1, 7 cm)
- CP300** 3 oz. (88.7 mL)  
2 ½" Dia. x 2 ¾" H, 3 ¾" W with Handle  
(5.4 x 6, 9.5 cm)
- CP500** 5 oz. (147.9 mL)  
2 ½" Dia. x 2 ¾" H, 4 ¼" W with Handle  
(6.4 x 7.3, 10.8 cm)



### Ceramic Bud Vases

These simple vases are designed to make the flowers inside pop with color.

#### Black

- BVJGB5** 2 ⅛" Dia. x 3 ⅞" H  
(5.4 x 9.8 cm)
- BVTB7** 1 ½" Dia. x 4" H  
(3.8 x 10.2 cm)

#### White

- BVJGG4** 2" Dia. x 3 ⅞" H  
(5.1 x 9.8 cm)
- BVTG6** 1 ½" Dia. x 4" H  
(3.8 x 10.2 cm)

#### Marble NEW

- BVJM8** 2 ⅛" Dia. x 3 ⅞" H  
(5.4 x 9.8 cm)
- BVTM9** 1 ½" Dia. x 4" H  
(3.8 x 10.2 cm)







## 2 oz. Contemporary Glass Shakers

With glass bodies and a variety of stainless steel tops, these shakers feature eye-catching contemporary design. 2" Dia. x 3 1/8" H (5.1 x 7.9 cm).

**GLACT2** Shaker with Cheese Top

**GLAST2** Shaker with Slotted Top

**GLADT2** Shaker with Adjustable Dial Top

**GLBASE** Shaker Base Only

### Replacement Shaker Tops

**CT2** Cheese Round Holes

**ST2** Spice Slotted

**DT2** Adjustable Dial Top

**CAP2** Plastic Cover for Top

## 6 oz. Contemporary Glass Shakers

This stylishly modern line of glass shakers is an instant classic. Each measures in at 2 3/8" Dia. x 4 1/2" H (6 x 11.4 cm).

**4406** Shaker with Cheese Top

**4407** Shaker with Slotted Top

**GLADT6** Shaker with Adjustable Dial Top

**GLA600** Shaker Base Only

### Replacement Shaker Tops

**4406T** Cheese Round Holes  
2 3/4" Dia. x 1 1/8" H (7 x 2.9 cm)

**4407T** Spice Slotted  
2 3/4" Dia. x 1 1/8" H (7 x 2.9 cm)

**DT6** Adjustable Dial Top  
2 3/4" Dia. x 1 1/8" H (7 x 2.9 cm)

**CAP25** Plastic Cover for Top



## 6 oz. Vintage Glass Shakers

Part of the Vintage Collection that includes the salt & pepper shakers on pg. 151, these cheese and spice shakers feature stainless steel caps and are dishwasher-safe.

**GSC6** Shaker with Cheese Top  
6 oz. (177.4 mL)  
2 5/8" Sq. x 3 3/4" H (6.7 x 9.5 cm)

**GSS6** Shaker with Slotted Top  
6 oz. (177.4 mL)  
2 5/8" Sq. x 3 3/4" H (6.7 x 9.5 cm)

**GSD6** Shaker with Adjustable Dial Top  
6 oz. (177.4 mL)  
2 5/8" Sq. x 3 3/4" H (6.7 x 9.5 cm)



#### 4 oz. Mason Jar Salt & Pepper Shaker Set

For a fun alternative use of these shakers, remove the caps and pair them with our flight boards (pg. 244) for craft beer tastings.

**MSP4** 4 oz. (118.3 mL)  
5" L x 4 3/4" W x 4" H  
(12.7 x 12.1 x 10.2 cm)

#### 6 oz. Swirl Jar Shakers

Our take on classic pizzeria styling. 6 oz. (177.4 mL) capacity.  
2 5/8" Dia. x 3 1/2" H (6.7 x 8.9 cm).

##### Glass

**3306** Shaker with Cheese Top

**3307** Shaker with Spice Top

##### PET

**LX306** Shaker with Cheese Top  
(not shown)

**LX307** Shaker with Spice Top  
(not shown)  
Shipped complete with tops.

#### 8 oz. Glass Shakers

Ideal for condiments such as red pepper, oregano and parmesan cheese. 8 oz. (236.6 mL) capacity.  
2 3/4" Dia. x 3 7/8" H (7 x 9.8 cm).

**3308** Shaker with Cheese Top

**3309** Shaker with Spice Top

#### 16 oz. Satin Finish Stainless Steel Shakers

In stainless steel, these shakers feature fine or coarse holes for different seasonings.  
16 oz. (473.2 mL) capacity.  
3" Dia. x 7" H (7.6 x 17.8 cm).

**TSF7** Shaker with Fine Holes

**TSC7** Shaker with Coarse Holes







BEE312

BEE317

BEE319

BEE318

BEE316



BEE607

BHM2



BEE606

### 12 oz. Glass Beehive Shakers

Our line of stylishly ridged beehive shakers begins with these standard 12 oz. (354.9 mL) pieces. 3" Dia. x 5 3/8" H (7.6 x 13.7 cm).

**BEE312** Shaker with Cheese Top

**BEE316** Shaker with Sugar Flap Top

**BEE317** Shaker with Spice Top

**BEE318** Shaker with Dredge Top

**BEE319** Shaker with Extra Large Holes Cheese Top

**BEE300** Shaker Base Only

### 2 oz. Glass Beehive Shakers

These 2 oz. (59.1 mL) beehive shakers feature a charming pear-shaped design. 2" Dia. x 3 3/4" H (5.1 x 9.5 cm).

**BHM2** Salt & Pepper Shakers

### 6 oz. Glass Beehive Shakers

These 6 oz. (177.4 mL) feature a ridged glass design. 2 3/4" Dia. x 4 1/8" H (7 x 10.5 cm).

**BEE606** Shaker with Cheese Top

**BEE607** Shaker with Spice Top

**BEE600** Shaker Base Only



### 12 oz. Shakers

These 12 oz. (354.9 mL) fluted shakers are stain-proof, dishwasher-safe and crafted from nearly indestructible SAN plastic or crystal clear glass. Sugar top has a self-closing flap. 3" Dia. x 5 3/8" H (7.6 x 13.7 cm).

#### Glass

- GLA312** Shaker with Cheese Top
- GLA316** Shaker with Sugar Flap Top
- GLA317** Shaker with Spice Top
- GLA318** Shaker with Dredge Top
- GLA319** Shaker with Extra Large 1/4" Holes Cheese Top
- GLA300** Shaker Base Only

#### SAN Plastic

- SAN312** Shaker with Cheese Top
- SAN316** Shaker with Sugar Flap Top
- SAN317** Shaker with Spice Top
- SAN318** Shaker with Dredge Top
- SAN319** Shaker with Extra Large 1/4" Holes Cheese Top
- SAN300** Shaker Base Only



### 12 oz. Plastic Shakers

These 12 oz. (354.9 mL) paneled shakers are stain-proof, dishwasher-safe and crafted from nearly indestructible plastic. Sugar top has a self-closing flap. 3" Dia. x 5 3/8" H (7.6 x 13.7 cm).

- 3312** Shaker with Cheese Top
- 3316** Shaker with Sugar Flap Top
- 3317** Shaker with Spice Top
- 3318** Shaker with Dredge Top
- 3319** Shaker with Extra Large 1/4" Holes Cheese Top
- 3300** Shaker Base Only





**NEW**

### Glass Syrup Dispenser <sup>NEW</sup>

With this contemporary design, this durable glass syrup dispenser is a great addition to any tabletop. Featuring an easy-pour lever and screw-on top, this dispenser efficiently serves your syrup, honey, and dressings. Replacement top available separately.

- SD10** Syrup Dispenser with Screw-On Top  
10 oz. (295.7 mL)  
3 1/4" Dia. x 5" H (8.3 x 12.7 cm)

**SGLR** Chrome Plated Syrup Replacement Lid



### Mini Glass Shakers and Caddy

This stainless steel rack and its matching glass shakers are a fraction of the size of regular shakers.

- MGLA3** 2 oz. (59.1 mL) Jar  
1 5/8" Dia. x 3 5/8" H (4.1 x 9.2 cm)

- MCADDY** Caddy  
4 1/2" L x 2 1/4" W x 5 1/2" H (11.4 x 5.7 x 14 cm)

- MGLCS** Set (Includes Caddy and Cheese with Spice Shakers)

### Replacement Shaker Tops

- M30SP** Salt and Pepper
- M312T** Cheese
- M316T** Sugar Flap Top
- M317T** Spice

### Shaker Tops

#### 6 oz. and 8 oz. Tops

- 3307T** Spice Slotted
- 3306T** Cheese Round

#### 12 oz. Tops

- 3312T** Cheese
- 3316T** Sugar Top Flap
- 3317T** Slotted Spice
- 3319T** Cheese Shaker with Extra Large Holes (1/4" Hole)
- 3318T** Dredge with Small Round Holes



## Glass Lightbulb Salt & Pepper Shaker Sets

A shaker and conversation piece, all in one. These eclectic shakers look just like the real thing.

**SPLB7** 4 oz. (118.3 mL)  
2 1/8" Dia. x 4" H (5.4 x 10.2 cm)

**SPLBCAP** Replacement Caps  
1" Dia. x 3/4" H (2.5 x 1.9 cm)

## Vintage Glass Salt & Pepper Sets

A timeless way to keep the essentials on hand, these salt & pepper sets add a dash of retro style to diner booths and dinner tables.

**GSPR** Ribbed Round  
2 oz. (59.1 mL)  
1 1/2" Dia. x 4 1/2" H (3.8 x 11.4 cm)

**GSPC** Round  
2 oz. (59.1 mL)  
1 1/2" Dia. x 4 1/2" H (3.8 x 11.4 cm)

**GSPSR** Ribbed Square  
2 oz. (59.1 mL)  
2" Sq. x 2 1/2" H (5.1 x 6.3 cm)

**GSPS** Square  
2 oz. (59.1 mL)  
2" Sq. x 2 1/2" H (5.1 x 6.3 cm)

**GR2** Replacement Caps  
1 1/2" Dia. x 1/2" H (3.8 x 1.3 cm)

## Vintage Salt & Pepper Caddies

Specifically designed to go with our Vintage Salt & Pepper Shakers, this beautiful caddy is crafted from your choice of acacia or stainless steel for a timeless look. Shakers sold separately.

### Acacia Wood

**CADDYW** Fits GSPR and GSPC S&P Shakers  
5" L x 2 1/2" W x 6 3/4" H  
(12.7 x 6.4 x 17.1 cm)

### Stainless Steel

**CADDYSS** Fits GSPR and GSPC S&P Shakers  
4 3/4" L x 2 1/2" W x 6 5/8" H  
(12.1 x 6.4 x 16.8 cm)







### Glass Salt & Pepper Shakers

These classically shaped shakers feature paneled glass and chrome or stainless steel tops. Your choice of top style: Petite, Eiffel Tower, Mushroom Cap or Bullet.

- SP125** Petite  
½ oz. (14.8 mL)  
2" H (5 cm)
- SP126** Eiffel Tower  
1 ¼ oz. (37 mL)  
4 ½" H (11.4 cm)
- PNS13** Mushroom Cap  
1 oz. (29.6 mL)  
3" H (7.6 cm)
- PNS24** Mushroom Cap  
2 oz. (59.1 mL)  
4" H (10.2 cm)
- BPNS115** Bullet  
1 ½ oz. (44.4 mL)  
3" H (7.6 cm)
- TOPPNS1** Replacement Tops for PNS24

### Acrylic Salt & Pepper Combo

Save table space with this rectangular two-in-one shaker.

- CPM62** 3 ½ oz. (103.5 mL)  
1 ½" Sq. x 6 ½" H  
(3.8 x 16.5 cm)



CPM62



### Ceramic Salt & Pepper Shaker Sets

In your choice of three contemporary shapes, these simple shakers deliver graphic simplicity.

- CSPT2** Round Tapered  
2 ½ oz. (73.9 mL)  
1 ¾" Dia. x 3" H (4.4 x 7.6 cm)
- CSPS3** Square  
2 ½ oz. (73.9 mL)  
3 ¼" Sq. x 3 ⅜" H (8.3 x 8.6 cm)
- CSPR1** Round  
2 ½ oz. (73.9 mL)  
3 ¼" Dia. x 3 ⅜" H (8.3 x 8.6 cm)
- CCPLUGS** Replacement Stoppers

### Ceramic Mason Jar Salt & Pepper Shaker Set

Bring farm-to-table charm to your presentation with these Mason jar-inspired shakers.

- CMSP** 2 oz. (59.1 mL)  
1 ½" Dia. x 3" H (3.8 x 7.6 cm)



### Porcelain Salt & Pepper Set

The artful simplicity of these teardrop-shaped shakers complements even the most refined table settings.

- PSP2** 2 oz. (59.1 mL)  
2" Dia. x 2 ¼" H (5.1 x 5.7 cm)



### Porcelain Salt & Pepper Dishes

Incorporate a tactile element into your dinner service by replacing "shake" with "pinch."

- PSLT17** ½ oz. (14.8 mL)  
1 ¾" Dia. x ¾" H (4.4 x 1.9 cm)
- PSLT2** 1 oz. (29.6 mL)  
2 ⅞" Dia. x 1" H (5.4 x 2.5 cm)







## Stainless Steel Salt & Pepper Shaker Sets

This contemporary design can read as futuristic, industrial or just plain stylish depending on the setting.

### Silver

**SSP2** Brushed Finish  
2 oz. (59.1 mL)  
1 3/4" Dia. x 2 3/4" H (4.4 x 7 cm)

**HMSP2** Hammered Finish  
2 oz. (59.1 mL)  
1 3/4" Dia. x 2 3/4" H (4.4 x 7 cm)

**HMPLUGS** Clear Replacement Stoppers

### Copper

**CSP2** Brushed Finish  
2 oz. (59.1 mL)  
1 3/4" Dia. x 2 3/4" H (4.4 x 7 cm)

**CHSP2** Hammered Finish  
2 oz. (59.1 mL)  
1 3/4" Dia. x 2 3/4" H (4.4 x 7 cm)

**HMPLUGS** Clear Replacement Stopper

### Black

**BHSP2** Hammered Finish  
2 oz. (59.1 mL)  
1 3/4" Dia. x 2 3/4" H (4.4 x 7 cm)

**BHMLUGS** Black Replacement Stoppers

### Gold

**GHSP2** Hammered Finish  
2 oz. (59.1 mL)  
1 3/4" Dia. x 2 3/4" H (4.4 x 7 cm)

**HMPLUGS** Clear Replacement Stoppers

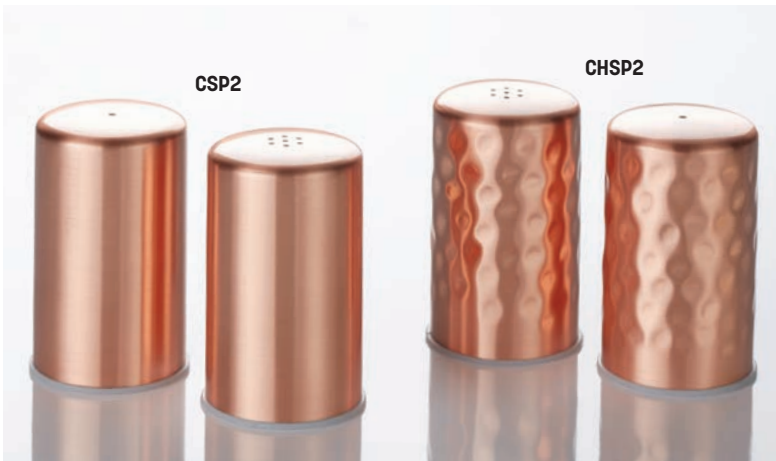

## Modern Stainless Steel Salt & Pepper Shaker Sets

Choose from funky, whimsical styles in satin-finished stainless steel. Also available in dishwasher-safe black and gold options (color may vary slightly).

### Silver

- SPDX33** 3 oz. (88.7 mL)  
1" Sq. x 3 3/4" H (2.5 x 9.5 cm)
- DXP4** 2 oz. (59.1 mL)  
1" Sq. x 4" H (2.5 x 10.2 cm)
- SPDX11** 4 oz. (118.3 mL)  
3 1/8" L x 2 5/8" H (7.9 x 6.7 cm)
- SPDX22** 3 oz. (88.7 mL)  
3 1/4" W x 2 5/8" H (8.3 x 6.7 cm)

### Gold

- SPDG33** 3 oz. (88.7 mL)  
1" Sq. x 3 3/4" H (2.5 x 9.5 cm)
- SPDG11** 4 oz. (118.3 mL)  
3 1/8" L x 2 5/8" H (7.9 x 6.7 cm)

### Black

- SPDB33** 3 oz. (88.7 mL)  
1" Sq. x 3 3/4" H (2.5 x 9.5 cm)
- SPDB11** 4 oz. (118.3 mL)  
3 1/8" L x 2 5/8" H (7.9 x 6.7 cm)
- SPPLUGS** Replacement Stoppers

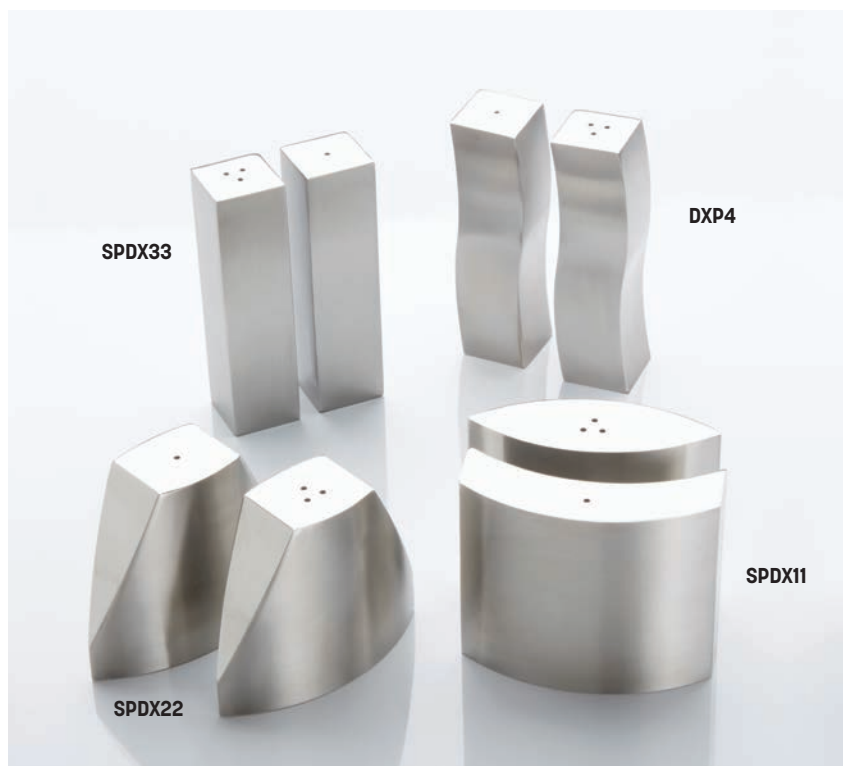

## Satin Finish Stainless Steel Salt & Pepper Shaker Set

A stainless steel set for the contemporary scene, these shakers deliver just the right amount of flash.

- SPM4** 3 oz. (88.7 mL)  
1 3/4" Dia. x 4" H (4.4 x 10.2 cm)

## Brushed Stainless Steel

### Salt & Pepper Shaker Sets HOT

Give your tabletops a contemporary upgrade with these brushed stainless steel shakers.

- SP29** Round  
1 oz. (29.6 mL) 3" H (7.6 cm)
- SP4** Rectangular  
2 oz. (59.1 mL) 2 1/2" H (6.4 cm)
- SP35** Round  
1 1/2 oz. (44.4 mL) 3 1/2" H (8.9 cm)
- SP6** Round with Caddy  
1 oz. (29.6 mL) 3 1/4" H (8.3 cm)





## Salt and Pepper Mill Sets

### Red

**PMSR62** Salt & Pepper Set  
6" H (15.2 cm)

**PMKNOB** Replacement Screw

### White

**PMSW62** Salt & Pepper Set  
6" H (15.2 cm)

**PMKNOB** Replacement Screw

### Bamboo

**PMSBA62** Salt & Pepper Set  
6" H (15.2 cm)

**PMKNOB** Replacement Screw

### Acrylic

**PMSA62** Salt & Pepper Set  
6" H (15.2 cm)

**PMKNOB** Replacement Screw

## Presto-Push Pepper Mill

**PMG6** 6" H (15.2 cm)



## Pepper Mills

### Stainless Steel

**PMSS62** Salt & Pepper Set  
6" H (15.2 cm)

**PMSS12** Pepper Mill  
12" H (30.5 cm)

**PMSKNOB** Replacement Screw

### Black

**PMSBL62** Salt & Pepper Set  
6" H (15.2 cm)

**PMBL8** Pepper Mill  
8" H (20.3 cm)

**PMBL12** Pepper Mill  
12" H (30.5 cm)

**PMKNOB** Replacement Screw

### Mahogany

**WPMS62** Salt & Pepper Set  
6" H (15.2 cm)

**WPM8** Pepper Mill  
8" H (20.3 cm)

**WPM12** Pepper Mill  
12" H (30.5 cm)

**WPM18** Pepper Mill  
18" H (45.7 cm)

**PMKNOB** Replacement Screw





Shown with WB33 water bottle

USE WITH CLEAR ACRYLIC  
WATER BOTTLES ON PG. 348

PRS2

### Stainless Steel Salad Dressing Pourer

This easy-to-clean stainless steel pourer is a brilliant way to repurpose our Acrylic Water Bottles. Just fit the plastic cork into the neck and use the bottle to dispense salad dressing or oil. **Sold in a pack of 12.**

**PRS2** Fits WB32, WB33, WB34, WB35  
2" Dia. x 3 1/4" H (5.1 x 8.3 cm)

### Oil & Vinegar Cruets

For something your customers have never seen before, these hand-blown glass designs feature an inner chamber for vinegar and an outer chamber for oil. An ideal accessory for keeping up with the gastronomic fad.

**OVJ1** Inner Capacity, 2 oz. (59.1 mL)  
Outer Capacity, 10 1/2 oz. (310.5 mL)  
2 1/2" Dia. x 6 1/4" H (6.3 x 15.9 cm)

**OVJ2** Inner Capacity, 3 oz. (88.7 mL)  
Outer Capacity, 13 1/2 oz. (399.2 mL)  
3 3/4" Dia. x 5 3/4" H (9.5 x 14.6 cm)

**OVJS** Replacement Stoppers

OVJ1

OVJ2



### Curved Wire Paper Towel Holders

A normally ordinary product made extraordinary with modern, unique styling.

**PTCC** Stainless Steel  
7" Dia. x 13" H (17.8 x 33 cm)

**PTBC** Black  
7" Dia. x 13" H (17.8 x 33 cm)

### Contemporary Paper Towel Holders

Two classic table pieces in one smartly designed product.

**PTCR** Stainless Steel  
7" Dia. x 13" H (17.8 x 33 cm)

**PTBR** Black  
7" Dia. x 13" H (17.8 x 33 cm)

### Wrought Iron Paper Towel Holder

Durable wrought iron meets a playful wavy design.

**THN61** 6" Dia. x 12" H (15.2 x 30.5 cm)

### Straw Dispenser

Crafted from stainless steel and plastic, this retro straw dispenser is fun to look at and easy to use.

**SD3511** 3 1/2" Dia. x 10 3/4" H (8.9 x 27.3 cm)







### Cake Stand & Cover

Stand is constructed from bright-finished stainless steel. Cover is made of break-resistant heavy clear plastic. Shipped in three pieces.

- 19SET** Base & Cover Set
- 19001** Stand Only  
13 1/2" Dia. x 7 1/2" H (34.3 x 19.1 cm)
- 19004** Cover Only  
12" Dia. x 6" H (30.5 x 15.3 cm)

### Stainless Steel Snail Plate, Tong and Fork

- SNF700** Snail Fork  
7" L (17.8 cm)
- SN60** Six-Compartment Plate
- SNT612** Satin Finish Snail Tong

### Lobster/Nut Crackers

- LNC602** Cast Iron, 6 3/8" L (16.2 cm)
- LN722** Chrome, 6 3/8" L (16.2 cm)





### Stainless Steel Au Gratin Dishes

In multiple sizes, these serving dishes feature timeless design and subtle metalwork.

#### Round

- AR060** 6 oz. (177.4 mL)  
6 3/4" Dia. x 5 1/2" Top ID (17.1 x 14 cm)
- AR080** 8 oz. (236.6 mL)  
7 1/4" Dia. x 5 5/8" Top ID (18.4 x 14.3 cm)
- AR100** 10 oz. (295.7 mL)  
6 7/8" Dia. x 6" Top ID (17.5 x 15.2 cm)

#### Oval

- A0080** 8 oz. (236.6 mL)  
8 1/8" L x 4 1/4" W x 1 1/4" H (20.6 x 10.8 x 3.2 cm)
- A0120** 12 oz. (354.9 mL)  
8 7/8" L x 4 1/2" W x 1 1/4" H (22.5 x 11.4 x 3.2 cm)
- A0150** 15 oz. (443.6 mL)  
9 5/8" L x 5" W x 1 1/2" H (24.4 x 12.7 x 3.8 cm)

### Counter Setup Menu Holder

Polished heavy-gauge stainless steel. Screws and bracket included.

- CS125** Holder  
15 1/2" L x 5" H (39.4 x 12.7 cm)



### Butter Warmer

- BWR34** Ceramic Ramekin  
4 oz. (118.3 mL)  
Stand  
3 1/4" Dia. x 3 7/8" H (8.3 x 9.8 cm)
- RAM1** Replacement Ramekin for BWR34  
4 oz. (118.3 mL)





AVAILABLE IN TWO SIZES AND  
IN THREE COLORS



WTSM31



WTSW32



WTSB33



CTS31

TRSD1815

HOT

### Wood Tray Stands

Your servers will appreciate that these elegant tray stands open with one hand, fold for easy storage and hold heavy loads. Featuring nylon straps and real wood.

#### Mahogany

**WTSM31** 17" W x 31" H (43.2 x 78.7 cm)

**WTSM38** 18" W x 38" H (45.7 x 96.5 cm)  
(not shown)

#### Walnut

**WTSW32** 17" W x 31" H (43.2 x 78.7 cm)

**WTSW39** 18" W x 38" H (45.7 x 96.5 cm)  
(not shown)

#### Black Finish

**WTSB33** 17" W x 31" H (43.2 x 78.7 cm)

**WTSB40** 18" W x 38" H (45.7 x 96.5 cm)  
(not shown)

### Deluxe Metal Tray Stands HOT

Choose from polished chrome or black chrome plate tubular steel with black nylon straps. Black plastic feet prevent damage to floors.

**CTS31** Black Chrome  
19 1/2" L x 15" W x 31" H  
(49.5 x 38.1 x 78.7 cm)

**TRSD1815** Polished Chrome  
19 1/2" L x 15" W x 31" H  
(49.5 x 38.1 x 78.7 cm)



FITS OVER 27" OVAL TRAYS  
AND INSIDE 29" OVAL TRAYS

ATCU

### Antimicrobial Oval Tray Cover

Protect an entire tray of food with just one cover. Ingeniously designed to work with the most popular 27" and 29" oval serving trays, this cover helps deliver food safely from kitchen to table while keeping meals warm and free from contaminants. Made of antimicrobial, dishwasher-safe ABS plastic, this cover not only minimizes germs on its surface but also can be safely sanitized after use. The ideal companion for any server.

**ATCU** 27 7/8" L x 22 1/2" W x 5 5/8" H  
(70.8 x 57.2 x 14.3 cm)

### Plastic Plate Cover HOT

Made of durable and dishwasher-safe ABS plastic, this plate cover provides full coverage (no finger or steam hole) for safely delivering food to the table. Universal crown on top of cover allows for quick and easy stacking while innovative inside sizing system allows for fit on plates 10 to 11 1/2" (25.4 to 29.2 cm) in diameter.

**APCU** 11 7/8" Dia. x 2 7/8" H  
(30.2 x 7.3 cm)



HOT

APCU

Shown with MCBPBSS bill presenter and PORSD3R sauce dish

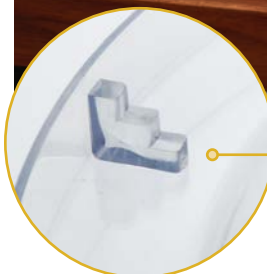

CAN COVER AND STACK ON PLATES  
10 TO 11 1/2" IN DIAMETER





## STANDARD STOCKED PLATE COVERS

Need to please a crowd in a pinch? Our most popular plate covers are now available for rapid turnaround. Made of durable satin-finished stainless steel, these covers feature top-of-the-line heat retention and odor resistance. A well in the top of each cover fits the foot of many different plates. Just measure the diameter of the plate and note the design of the foot to determine the best option. We can also help guide you to the right cover choice with key details about the plate (manufacturer, model and/or size) or by sending a sample plate. All covers are 2" in height and include a finger hole. For help ordering, call 800-333-9133 or email [platecovers@amnow.com](mailto:platecovers@amnow.com).

### Round Standard Stocked Stainless Steel Plate Covers

<b>PC0600S</b>	Fits plates 5 <sup>5</sup> / <sub>8</sub> " to 6" Dia. (14.3 x 15.2 cm) with Standard or Wide Foot	<b>PC1068S</b>	Fits plates 10 <sup>7</sup> / <sub>16</sub> " to 10 <sup>1</sup> / <sub>4</sub> " Dia. (26.5 to 27.1 cm) with Narrow Foot
<b>PC0688S</b>	Fits plates 6 <sup>3</sup> / <sub>8</sub> " to 6 <sup>7</sup> / <sub>8</sub> " Dia. (16.8 x 17.5 cm) with Standard, Narrow or Wide Foot	<b>PC1093R</b>	Fits plates 10 <sup>1</sup> / <sub>2</sub> " to 10 <sup>7</sup> / <sub>8</sub> " Dia. (26.7 to 27.6 cm) with Standard or Narrow Foot
<b>PC0788S</b>	Fits plates 7 <sup>5</sup> / <sub>8</sub> " to 7 <sup>7</sup> / <sub>8</sub> " Dia. (19.4 x 20 cm) with Standard or Narrow Foot	<b>PC1093E</b>	Fits plates 10 <sup>1</sup> / <sub>2</sub> " to 10 <sup>7</sup> / <sub>8</sub> " Dia. (26.7 to 27.6 cm) with English-Style or Wide Foot
<b>PC0825S</b>	Fits plates 8 <sup>1</sup> / <sub>16</sub> " to 8 <sup>1</sup> / <sub>4</sub> " Dia. (20.5 to 21 cm) with Standard or Wide Foot	<b>PC1112S</b>	Fits plates 11" to 11 <sup>1</sup> / <sub>8</sub> " Dia. (27.9 to 28.3 cm) with Standard or Wide Foot
<b>PC0875S</b>	Fits plates 8 <sup>3</sup> / <sub>8</sub> " to 8 <sup>13</sup> / <sub>16</sub> " Dia. (21.3 to 22.4 cm) with Standard or Wide Foot	<b>PC1112R</b>	Fits plates 11" to 11 <sup>1</sup> / <sub>8</sub> " Dia. (27.9 to 28.3 cm) with Standard or Narrow Foot
<b>PC0900S</b>	Fits plates 8 <sup>15</sup> / <sub>16</sub> " to 9 <sup>1</sup> / <sub>8</sub> " Dia. (22.7 to 23.2 cm) with Standard or Wide Foot	<b>PC1150S</b>	Fits plates 11 <sup>1</sup> / <sub>8</sub> " to 11 <sup>1</sup> / <sub>2</sub> " Dia. (28.3 to 29.2 cm) with Standard or English-Style Foot
<b>PC0950R</b>	Fits plates 9 <sup>1</sup> / <sub>4</sub> " to 9 <sup>1</sup> / <sub>2</sub> " Dia. (23.5 to 24.1 cm) with Standard Foot	<b>PC1175R</b>	Fits plates 11 <sup>5</sup> / <sub>8</sub> " to 11 <sup>3</sup> / <sub>4</sub> " Dia. (29.5 to 29.8 cm) with Standard Foot
<b>PC0988S</b>	Fits plates 9 <sup>5</sup> / <sub>8</sub> " to 9 <sup>7</sup> / <sub>8</sub> " Dia. (24.4 to 25.1 cm) with Standard or English-Style Foot	<b>PC1206R</b>	Fits plates 11 <sup>3</sup> / <sub>4</sub> " to 12 <sup>1</sup> / <sub>16</sub> " Dia. (29.8 to 30.6 cm) with Standard Foot
<b>PC1025S</b>	Fits plates 10" to 10 <sup>1</sup> / <sub>4</sub> " Dia. (25.4 to 26 cm) with Standard or English-Style Foot	<b>PC1244R</b>	Fits plates 12 <sup>1</sup> / <sub>8</sub> " to 12 <sup>7</sup> / <sub>16</sub> " Dia. (30.8 to 31.6 cm) with Standard Foot
<b>PC1062E</b>	Fits plates 10 <sup>3</sup> / <sub>8</sub> " to 10 <sup>5</sup> / <sub>8</sub> " Dia. (26.4 to 27 cm) with English-Style or Wide Foot	<b>PC1250S</b>	Fits plates 12 <sup>3</sup> / <sub>16</sub> " to 12 <sup>9</sup> / <sub>16</sub> " Dia. (31 to 31.9 cm) with Standard, Narrow or Wide Foot
<b>PC1068R</b>	Fits plates 10 <sup>7</sup> / <sub>16</sub> " to 10 <sup>1</sup> / <sub>4</sub> " Dia. (26.5 to 27.1 cm) with Standard Foot	<b>PC1300S</b>	Fits plates 12 <sup>5</sup> / <sub>8</sub> " to 13" Dia. (32 to 33 cm) with Standard, Narrow or Wide Foot

NEW



**Non-Skid Plate Cover Pads**

Stack your orders and serve with confidence. These non-skid pads fit on top of plate covers, securing each plate in place during transport. Made of textured silicone for extra resistance. Sold in a pack of 12.

**SCP65** 6 1/2" Dia. (16.5 cm)

**SCP8** 8" Dia. (20.3 cm)

**Plate Cover Plug**

Not everyone loves a finger hole. Now there is an easy way to cover the hole of a plate cover for safe, secure transport. Made of durable yet flexible silicone, these plate cover plugs are designed to fit the finger holes of our standard stocked plate covers. Sold in a pack of 12.

**PCP12** 7/8" Dia. (2.2 cm)



PCP12



SCP65 shown with PC0988S plate covers

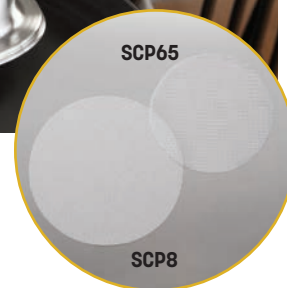

**CUSTOM PLATE COVERS**

For more information or to receive a quote, call 800.333.9133 or email [platecovers@amnow.com](mailto:platecovers@amnow.com). Sample of plate may be required for evaluation.





## CUSTOM PLATE COVERS

For more information or to receive a quote, call 800.333.9133 or email [platecovers@amnow.com](mailto:platecovers@amnow.com). Sample of plate may be required for evaluation.



SCRACK5

### Plate Cover Cart

Aluminum base with five casters. Comes with a steel screw-in bar. Holds up to 175 covers.

**SCRACK5** 40 1/4" H x 20" Dia. Overall  
(102.2 x 50.8 cm)  
Pole 37 1/4" H x 5/8" Dia.  
(94.6 x 1.6 cm)  
Base 4" H (10.2 cm)

### Condiment or Relish Jar Cover

Stainless steel with a deluxe finish. Comes with a heavy riveted stainless knob. Slotted to accommodate dauber spoon.

**RD412** Standard size  
3 1/8" ID (7.94 cm)

RD412



# Buffet & Display







SLOW-RELEASE GLASS LID

REVLRD20 shown with REVLRD20BASE

INCLUDES A CONVENIENT SPOON HOLDER

## THE EVOLUTION™ COLLECTION

The sharpest, most contemporary designs in the restaurant world need not be limited to the dinner table. The Evolution Collection from American Metalcraft features simple, elegant designs in stainless steel for today's buffets.

### Evolution Round Chafer

Chafer features an induction base and comes complete with a stainless steel spoon holder. Stand sold separately.

**REVLRD20** 7 qt. (6.6 L)  
20 ½" L x 20" W x 12" H  
(52.1 x 50.8 x 30.5 cm)

Note: For use on induction units greater than 1800 watts.

#### Replacement Parts

**REVLRD20BASE** Stand with Fuel Holder  
14 ½" L x 17" W x 5 ¾" H  
(36.8 x 43.2 x 14.6 cm)

**CSR26** Spoon Holder

**RFP18RD** Round Food Pan

### Evolution Rectangular Chafer

Chafer features an induction base and comes complete with a stainless steel spoon holder. Stand sold separately.

**REVLRT26** 9 qt. (8.5 L)  
26" L x 18" W x 12" H  
(66 x 45.7 x 30.5 cm)

Note: For use on induction units greater than 1800 watts.

#### Replacement Parts

**REVLRT26BASE** Stand with Fuel Holders  
22" L x 16" W x 5 ¾" H  
(55.9 x 40.6 x 14.6 cm)

**CSR26** Spoon Holder

**CDFP88** Rectangular Food Pan



REVLRT26 shown with REVLRT26BASE



REVLUICESQ12

### Evolution Juice Dispenser

Give brunch a dose of elegance. The polycarbonate body features an offset ice reservoir for easier dispensing and refilling. Legs, lid and frame crafted from sleek stainless steel.

**REVLUICESQ12** 12 qt. (11.4 L)  
 11" L x 12" W x 23 1/8" H  
 (27.9 x 30.5 x 58.7 cm)



#### Replacement Parts

- JFAUC8** Faucet
- JTUBE6** Stainless Steel Ice Tube
- JCOV6** Stainless Steel Cover
- JREP6** Polycarbonate Body



### Evolution Coffee Urn

A simple, futuristic design makes this all-stainless steel piece shine. With high-quality faucet and fuel holder.

**REVLOSCU12** 12 qt. (11.4 L)  
 11" L x 13 3/8" W x 21 1/4" H  
 (27.9 x 34 x 54 cm)

#### Replacement Parts

- AFAUC1** Faucet

**WARNING:** This product can expose you to chemicals including Bisphenol A (BPA), which is known to the State of California to cause birth defects or other reproductive harm. For more information, go to <http://www.P65warnings.ca.gov>. Warning applies to State of California only.

### Evolution Beverage Urn

Serve ice-cold juice by day and piping-hot coffee by night with this versatile stainless steel urn. Includes a fuel holder and ice reservoir.

**REVLURN12** 12 qt. (11.4 L)  
 10 1/4" L x 12 3/8" W x 20 7/8" H  
 (26 x 32.1 x 53 cm)

#### Replacement Parts

- AFAUC1** Faucet

### Drip Trays

These stainless steel drip trays keep buffet spaces clean without sacrificing aesthetics.

**DT3** Round  
 5 1/2" Dia. x 1/2" H  
 (14 x 1.3 cm)

**DT4** Square  
 6" Sq. x 1/2" H  
 (15.2 x 1.3 cm)



REVLOSCU12

REVLURN12 shown with MICH25 and MICH5 milk cans



COMPLETE THE LOOK WITH EVOLUTION CREAMERS ON PG.120



DT3



DT4





HOT

MESA72C



MESA72H



HOT

MESA91C



MESA91H

## THE MESA™ COLLECTION

Equally elegant and eye-catching, the Mesa Collection is a fabulous way to make your buffet service memorable. Featuring a classic combination of wrought iron and hammered copper or stainless steel, each of these items works independently or as a cohesive collection.

### Mesa Hammered Copper Roll-Top Chafers HOT 🔥

These 180° roll-top chafers are adorned with beautiful wrought iron trim and convenient built-in spoon holders. A locking mechanism allows the lid to remain open at 90° for a stunning presentation. Each chafers comes with a 22-gauge food pan, water pan and fuel holder.

**MESA91C** Round  
6 qt. (5.7 L)  
19" L x 20" W x 24" H  
(48.3 x 50.8 x 61 cm)

**MESA72C** Rectangular  
8 qt. (7.6 L)  
27 1/8" L x 21 1/4" W x 19 1/2" H  
(68.9 x 54 x 49.5 cm)

### Mesa Hammered Stainless Steel Roll-Top Chafers

**MESA91H** Round  
6 qt. (5.7 L)  
19" L x 20" W x 24" H  
(48.3 x 50.8 x 61 cm)

**MESA72H** Rectangular  
8 qt. (7.6 L)  
27 1/8" L x 21 1/4" W x 19 1/2" H  
(68.9 x 54 x 49.5 cm)

### Replacement Parts

- CDFP44** Round Food Pan
- CDWPM19** Round Water Pan
- CDFP33** Rectangular Food Pan
- CDWPM27** Rectangular Water Pan

Shown with GJ24 square glass jars,  
DM10WH mugs and BTS2 condiment rack



MESABUSH13



MESABUCH13

## Mesa Coffee Urns

The most stylish way to serve hot beverages. Designed to be paired with a Mesa Roll-Top Chafer.

### Silver

**MESABUSH13** 13 qt. (12.3 L)  
14 1/8" Dia. x 23 1/2" H  
(35.9 x 59.7 cm)

### Copper

**MESABUCH13** 13 qt. (12.3 L)  
14 1/8" Dia. x 23 1/2" H  
(35.9 x 59.7 cm)

### Replacement Parts

**AFAUC1** Faucet





### Adagio™ Chafers

These stainless steel roll-top chafers can be kept open at any angle. Choose the gold-handled option for an extra luxe flair. Comes complete with a food pan, water pan and fuel holder(s).

#### Silver-Handled

**ADAGIORD18** Round  
7 qt. (6.6 L)  
18" L x 18 ½" W x 18" H  
(45.7 x 47 x 45.7 cm)

**ADAGIORT26** Rectangular  
9 qt. (8.5 L)  
26 ½" L x 19 ½" W x 17 ½" H  
(67.3 x 49.5 x 44.5 cm)

#### Gold-Handled

**GOLDAGR18** Round  
7 qt. (6.6 L)  
18" L x 18 ½" W x 18" H  
(45.7 x 47 x 45.7 cm)

**GOLDAGR26** Rectangular  
9 qt. (8.5 L)  
26 ½" L x 19 ½" W x 17 ½" H  
(67.3 x 49.5 x 44.5 cm)

#### Replacement Parts

- RFP18RD** Round Food Pan
- CDWP18** Round Water Pan
- CDFP88** Rectangular Food Pan
- CDWP26** Rectangular Water Pan

### Applause™ Chafer

Your crowds will go wild over the satin-finished stainless steel, 90° roll-top rectangular chafer. Comes with standard water pan, food pan and two fuel holders.

**MACD3** 8 qt. (7.6 L)  
24 ½" L x 13 ¾" W x 15 ¼" H  
(62.2 x 34.9 x 38.7 cm)

#### Replacement Parts

- MACTOP** Lid

### Chafers Frames

All frames fit standard-sized chafers pans and feature slots for fuel holders. Choose the ornate option for extra style and functionality with spoon holders and side handles. Chafers kits sold separately.

#### Stackable

**SCF2** Wrought Iron Full-Size Frame  
24 1/2" L x 16 1/2" W x 8 1/4" H  
(62.2 x 41.9 x 21 cm)

#### Ornate

**CF1** Wrought Iron Full-Size Frame & Cup  
24" L x 13" W x 11" H  
(61 x 33 x 27.9 cm)

#### Chafers Frame Accessories

**CFKIT** Food Pan, Water Pan, Lid, (2) Fuel Holders

**CDFP55** Food Pan

**CDWP66** Water Pan

**CDCV77** Lid

#### Fuel Holder

**FH1** Stainless Steel  
3 3/4" Dia. x 2 1/2" H, 6 3/4" with Handle  
(9.5 x 6.4, 17.1 cm)

#### Adapter Bars

For dividing water pans into sections.

**AB131** 12 1/2" L (31.8 cm)

**AB211** 20 1/2" L (52.1 cm)

#### Stackable Storage Crate

This large container is especially practical for back-of-house storage. See pairing guide on pg. 456 for fit options.

**SCBL** 21 1/4" L x 17 5/8" W x 18 1/8" H  
(54 x 44.8 x 46 cm)



SCF2 shown with CFKIT

STACKABILITY MAKES STORAGE A CINCH



CF1 shown with CFKIT and SSP120 spoon



FH1



AB211

AB131

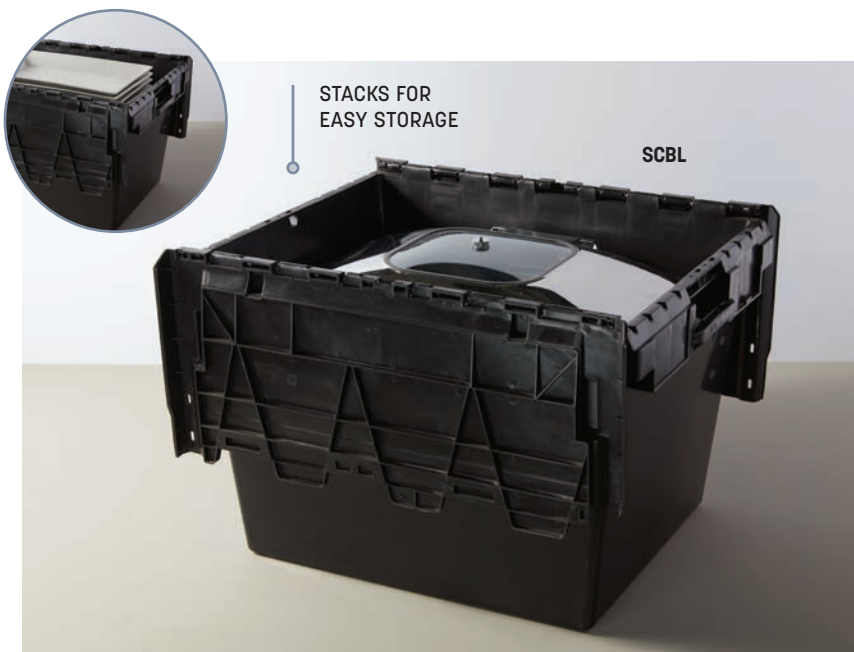

STACKS FOR EASY STORAGE

SCBL





### Folding Beverage Frames

Upgrade buffets in an instant with these collapsible frames. Use with food pans or beverage inserts, and then fold and stack for easy storage. In your choice of size and style.

#### Black Twilight Crates

- KBC6** 1/6-Size  
6 1/4" L x 5 3/4" W x 6 1/2" H  
(15.9 x 14.6 x 16.2 cm)
- KBC12** 1/3-Size  
12" L x 6 1/8" W x 6 3/8" H  
(30.5 x 15.6 x 16.2 cm)
- KBC10** Half-Size  
12 1/8" L x 10" W x 8 1/8" H  
(30.8 x 25.4 x 20.6 cm)
- KBC20** Full-Size  
20 3/8" L x 12 3/8" W x 8 1/4" H  
(51.8 x 31.4 x 21 cm)

#### Stainless Steel Milk Crates

- KSMC6** 1/6-Size  
6 1/4" L x 5 3/4" W x 6 1/2" H  
(15.9 x 14.6 x 16.5 cm)
- KSMC12** 1/3-Size  
12" L x 6 1/8" W x 6 3/8" H  
(30.5 x 15.6 x 16.2 cm)
- KSMC10** Half-Size  
12 1/8" L x 10" W x 8 1/8" H  
(30.8 x 25.4 x 20.6 cm)
- KSMC20** Full-Size  
20 1/4" L x 12 3/8" W x 8 1/4" H  
(51.4 x 31.4 x 21 cm)





### Twilight Griddle Stands

Elevate your brunch presentation with this trio of griddle stands. All three are crafted from stainless steel so they can stand the heat in style. Tapered for easy storage.

#### Black

- GSC16** Half-Size  
16" L x 8" W x 4 1/2" H  
(40.6 x 20.3 x 11.4 cm)
- GSC17** Round  
17" Dia. x 4 1/2" H  
(43.2 x 11.4 cm)
- GSC26** Full-Size  
26 1/4" L x 14" W x 4 1/2" H  
(66.7 x 35.6 x 11.4 cm)

#### Silver

- SGSC16** Half-Size  
16" L x 8" W x 4 1/2" H  
(40.6 x 20.3 x 11.4 cm)
- SGSC17** Round  
17" Dia. x 4 1/2" H  
(43.2 x 11.4 cm)
- SGSC26** Full-Size  
26 1/4" L x 14" W x 4 1/2" H  
(66.7 x 35.6 x 11.4 cm)





## Black Twilight Market Trays

Give your deli case an easy, stylish upgrade. A striking angular design gives these dishwasher-safe market trays a contemporary flair.

- MTB296** Rectangular  
29 3/4" L x 6 1/8" W x 2" H  
(75.6 x 15.6 x 5.1 cm)
- MTB298** Rectangular  
29 3/4" L x 8 1/2" W x 2" H  
(75.6 x 21.6 x 5.1 cm)
- MTB2910** Rectangular  
29 3/4" L x 10 1/2" W x 2" H  
(75.6 x 26.7 x 5.1 cm)
- MTB156** Rectangular  
15" L x 6" W x 2" H  
(38.1 x 15.2 x 5.1 cm)
- MTB159** Rectangular  
15" L x 9" W x 2" H  
(38.1 x 22.9 x 5.1 cm)
- MTB1512** Rectangular  
15" L x 12" W x 2" H  
(38.1 x 30.5 x 5.1 cm)
- SBBL** Rectangular  
16 3/8" L x 8 1/4" W x 2" H  
(41.6 x 21 x 5.1 cm)
- SBBS** Square  
8 1/8" Sq. X 2" H  
(20.6 x 5.1 cm)



Shown with COLDB8 cold cell and POR9 bowl

## Rubberized Wedges NEW

Level up your display - literally - with these handy rubberized wedges! The rubberized coating allows you to prop up crates and trays for full display. Available in different heights for different needs.

- DWRB2** 5" L x 3" W x 2 1/2" H  
(12.7 x 7.6 x 6.4 cm)
- DWRB5** 5" L x 5" W x 5" H  
(12.7 x 12.7 x 12.7 cm)  
(not shown)



## Ultra-Chill Cold Cell NEW

Keep food colder for longer. These cells freeze at 10° F and maintain cold temperatures up to four hours. Recharge in freezer for 24 hours.\*

- COLD8** 8" Sq. x 1 7/8" H  
(20.3 x 4.8 cm)



COLD CELL MUST MAINTAIN  
SURFACE-TO-SURFACE CONTACT  
FOR BEST PERFORMANCE

\*The performance of the cold cell will vary based on food types, environmental temperature and humidity and other external variables.





G30 shown on GSST2514 stand

G17 shown on GSSS20 stand

Marinated Vegetables



G30

### HAMMERED STAINLESS STEEL GRIDDLES AND STANDS

These gorgeous pieces lend a sparkling touch to any buffet. Each of these warming griddles is individually hammered, making no two alike. Pair them with matching contemporary stainless steel stands to complete the exquisite look.

#### Large Rectangular Griddle and Stand

**G30** Griddle  
30 3/4" L x 16 1/4" W x 1 3/4" H  
(78.1 x 41.3 x 4.4 cm)

**GSST2514** Stand  
26 1/4" L x 14" W x 4 1/4" H  
(66.7 x 35.6 x 10.8 cm)

#### Round Griddle and Stand

**G17** Griddle  
18" Dia. x 2" H  
(45.7 x 5.1 cm)

**GSSS20** Stand  
17" Dia. x 4 1/4" H  
(43.2 x 10.8 cm)



G17



**Oval Griddle and Stand**

**G23** Griddle  
23 3/4" L x 13 3/4" W x 1 3/4" H  
(60.3 x 34.9 x 4.4 cm)

**GSOVL** Stand  
20" L x 14" W x 4 3/4" H  
(50.8 x 35.6 x 12.1 cm)

**Small Rectangular Griddle and Stand**

**G21** Griddle  
21 3/4" L x 9" W x 1 1/2" H  
(55.2 x 22.9 x 3.8 cm)

**GSREC** Stand  
17 1/4" L x 9 1/4" W x 5" H  
(43.8 x 23.5 x 12.7 cm)

**Paella Pan and Stand**

**GP21** Paella Pan  
21 3/4" Dia. x 4 3/4" H  
(55.2 x 12.1 cm)

**GSSS20** Stand  
17" Dia. x 4 1/4" H  
(43.2 x 10.8 cm)





## Stainless Steel Griddles and Stands

### Round Griddle and Stand

**GSST17** Griddle  
17 1/2" Dia. x 2 1/8" H  
(44.5 x 5.4 cm)

**GSSS20** Stand  
17" Dia. x 4 1/4" H  
(43.2 x 10.8 cm)

### Rectangular Griddle and Stand

**GSSS1526** Griddle  
32 5/8" L x 16 1/2" W x 2 1/8" H  
(82.9 x 41.9 x 5.4 cm)

**GSST2514** Stand  
26 1/4" L x 14" W x 4 1/4" H  
(66.7 x 35.6 x 10.8 cm)

### Flame Guards

**FGRS7** 7" Dia. x 3 1/2" H  
(17.8 x 8.9 cm)

**FGRS10** 10" Dia. x 3 1/2" H  
(25.4 x 8.9 cm)



GSST17 shown with  
GSSS20 stand



GSSS1526 shown with  
GSST2514 stand

LASER-CUT FLAMES  
EMBELLISH THESE  
BRUSHED STAINLESS  
STEEL GUARDS THAT  
PROTECT FUEL CANS  
FROM WIND



FGRS10 shown with  
GSSS1526 griddle and  
GSST2514 stand

FGRS7 shown with  
GS1775 paella pan  
and GSS17 stand



GS1775 shown  
with GSS17 stand

### Wrought Iron Griddles and Stands

These griddles and stands are perfect for self-served breakfast, globally-inspired fare, tempting desserts and more.

#### Round Paella Pan and Stand

**GS1775** Paella Pan  
21 3/4" Dia. x 4 3/4" H  
(55.2 x 12.1 cm)

**GSS17** Stand  
17" Dia. x 4 1/4" H  
(43.2 x 10.8 cm)

#### Round Griddle and Stand

**GS18** Round Griddle with Stand  
18" Dia. x 4 1/4" H  
(45.7 x 10.8 cm)

**GS81** Griddle  
18" Dia. x 1" H  
(45.7 x 2.5 cm)

**GSS17** Stand  
17" Dia. x 4 1/4" H  
(43.2 x 10.8 cm)

#### Rectangular Griddles and Stands

**GS27** Full-Size Griddle with Stand  
27" L x 16" W x 5" H  
(68.6 x 40.6 x 12.7 cm)

**GS16** Half-Size Griddle with Stand (not shown)  
16" L x 13 1/2" W x 5" H  
(40.6 x 34.3 x 12.7 cm)

**G72** Full-Size Griddle  
27" L x 16" W x 1" H  
(68.6 x 40.6 x 2.5 cm)

**G61** Half-Size Griddle (not shown)  
16" L x 13 1/2" W x 1" H  
(40.6 x 34.3 x 2.5 cm)



GS18



GS27





## CAST IRON

Heavy-duty cast iron goes straight from oven to table and looks great at stations and buffets. In a variety of styles and sizes to accommodate the trendy rustic look.

### Round Cast Iron Fry Pans

- CIS8** 48 oz. (1.4 L)  
8" Dia. x 2 1/4" H  
13 3/4" L with Handle  
(20.3 x 5.7, 35 cm)
- CIS10** 64 oz. (1.9 L)  
10" Dia. x 2 1/4" H  
15 3/4" L with Handle  
(25.4 x 5.7, 40 cm)
- CIS12** 96 oz. (2.8 L)  
12" Dia. x 2 1/4" H  
19" L with Handle  
(30.5 x 5.7, 48.3 cm)
- CIS14** 128 oz. (3.8 L)  
14" Dia. x 3 1/2" H  
20" L with Handle  
(35.6 x 8.9, 50.8 cm)

### Large Cast Iron Casseroles

- CIPO3** 96 oz. (2.8 L)  
10 5/8" L x 8 1/8" W x 4 1/2" H  
12 1/2" L with Handles, 6 1/2" H with Knob  
(27 x 20.6 x 11.4, 31.8, 16.5 cm)
- CIPO4** 128 oz. (3.8 L)  
11 5/8" L x 8 1/4" W x 4 1/2" H  
14" L with Handles, 6 1/2" H with Knob  
(29.5 x 21 x 11.4, 35.6, 16.5 cm)
- CIPR3** 96 oz. (2.8 L)  
8 3/4" Dia. x 4" H  
11 1/4" L with Handles, 6" H with Knob  
(22.2 x 10.2, 28.6, 15.2 cm)  
(not shown)
- CIPR4** 128 oz. (3.8 L)  
9 1/2" Dia. x 4 1/4" H  
12" L with Handles, 6 1/2" H with Knob  
(24.1 x 10.8, 30.5, 16.5 cm)  
(not shown)



### Large Silicone Trivets

- TRVR8** Round  
8" Dia. x 1/4" H  
(20.3 x 0.6 cm)
- TRVR10** Round  
10" Dia. x 1/4" H  
(25.4 x 0.6 cm)

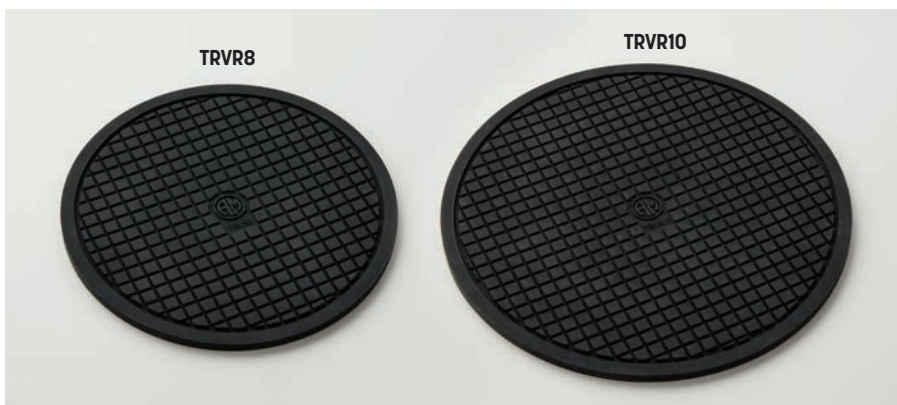

### Mini Fry Pans and Casseroles

- CIPRT5336** 9 ½ oz. (280.9 mL)  
5 ⅜" L x 3 ⅝" W x 1 ⅝" H, 7" L with Handles  
(13.7 x 9.2 x 4.1, 17.8 cm)
- CIPS61** 9 ½ oz. (280.9 mL)  
5 ¾" Sq. x ⅞" H, 7 ⅞" L with Handles  
(14.6 x 2.2, 18.1 cm)
- CIS41** 3 ½ oz. (103.5 mL)  
3 ⅞" Dia. x 1" H, 6 ⅞" L with Handle  
(9.8 x 2.5, 17.5 cm)
- CIS51** 8 ½ oz. (251.4 mL)  
5" Dia. x 1 ½" H, 8 ¼" L with Handle  
(12.7 x 3.8, 21 cm)
- CIS61** 15 ½ oz. (458.4 mL)  
6 ¼" Dia. x 1 ¼" H, 10" L with Handle  
(15.9 x 3.2, 25.4 cm)



### Mini Round Casseroles and Pots

- CIPR5125** 8 ½ oz. (251.4 mL)  
5" Dia. x 1 ¼" H, 6 ½" L with Handles  
(12.7 x 3.2, 16.5 cm)
- CIPR6250** 19 oz. (561.9 mL)  
6 ¼" Dia. x 1 ½" H, 8 ¾" L with Handles  
(15.9 x 3.8, 22.2 cm)
- CIPR7251** 27 oz. (798.5 mL)  
7 ¼" Dia. x 1 ¾" H, 9 ⅝" L with Handles  
(18.4 x 4.4, 24.5 cm)
- CIPR42** 9 oz. (266.2 mL)  
4" Dia. x 2" H, 5 ⅝" L with Handles  
3" H with Knob  
(12.7 x 5.1, 14.3, 6 cm)
- CIPR5500** 19 oz. (561.9 mL)  
5" Dia. x 2 ¼" H, 6 ½" L with Handles  
3 ¾" H with Knob  
(12.7 x 5.7, 16.5, 9.5 cm)
- CIPR5526** 27 oz. (798.5 mL)  
5 ½" Dia. x 2 ⅝" H, 7 ⅝" L with Handles  
4" H with Knob  
(14 x 6.6, 19.4, 10.2 cm)



### Mini Oval Casseroles and Pots

- CIPOV856** 27 oz. (798.5 mL)  
8 ½" L x 6" W x 1 ¾" H, 10 ⅞" L with Handles  
(21.6 x 15.2 x 4.5, 27.6 cm)
- CIPOV9567** 36 ½ oz. (1.1 L)  
9 ½" L x 6 ⅝" W x 2" H, 12" L with Handles  
(24.1 x 16.2 x 5.1, 30.5 cm)
- CIPOV63** 11 ½ oz. (340.1 mL)  
5" L x 2 ⅝" W x 2" H, 6 ½" L with Handles  
3" H with Knob  
(12.7 x 6.7 x 5, 16.5, 7.6 cm)
- CIPOV6040** 17 ½ oz. (517.5 mL)  
6" L x 4" W x 2 ½" H, 7 ½" L with Handles  
3 ⅞" H with Knob  
(15.2 x 10.2 x 6.4, 19.1, 9.8 cm)
- CIPOV745** 23 ½ oz. (695 mL)  
7" L x 4 ½" W x 2 ¼" H, 8 ½" L with Handles  
4" H with Knob  
(17.8 x 11.4 x 5.7, 21.6, 10.2 cm)



### Mini Griddle

- CIG85** 8 ¼" L x 5 ¾" W x ¾" H, 9 ½" L with Handles  
(21 x 14.6 x 1.9, 24.1 cm)





# Mix-and-Match Juice Dispensers

These pieces are all stylishly interchangeable. Just choose a body and a base, and create a unique look that's as refreshing as the beverages you're serving. Bodies come complete with faucet, cover, ice tube and insert.

**STEP 1**  
Pick a Body Size

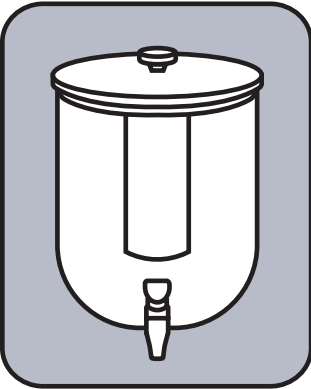

+

**STEP 2**  
Pick a Base.

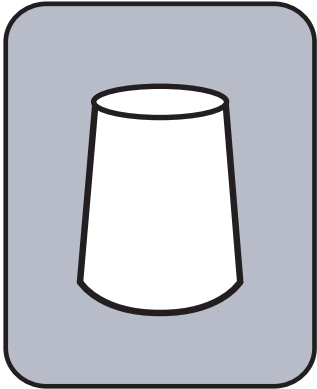

=

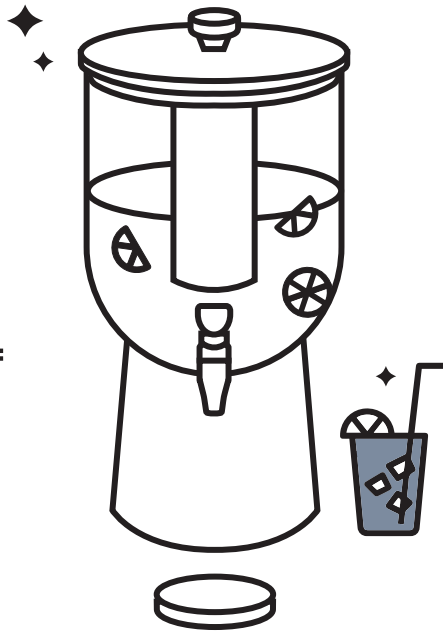

JBASE1 shown with JUICE4



JBASE7 shown with JUICE3





### Tritan Plastic Dispenser Bodies

- JUICE3** Body, 12 qt. (11.4 L)  
11" L x 10 1/4" W x 13 1/2" H  
(27.9 x 26 x 34.3 cm)
- JUICE4** Body, 20 qt. (18.9 L)  
12 1/2" L x 12" W x 20 1/2" H  
(31.8 x 30.5 x 52.1 cm)

### Dispenser Bases

- JBASE1** Hammered Stainless Steel Base  
8" Dia. x 7 3/4" H (20.3 x 19.7 cm)
- JBASE2** Wrought Iron Juice Base  
8" Dia. x 8" H (20.3 x 20.3 cm)
- JBASE5** Black Twilight Base  
8" Dia. x 8" H (20.3 x 20.3 cm)
- JBASE6** Black Twilight Base  
9" Dia. x 12" H (22.9 x 30.5 cm)
- JBASE7** Hammered Stainless Steel Base  
9" Dia. x 12" H (22.9 x 30.5 cm)
- JBASEMEL8** Acacia/Marble Melamine Base  
11 1/4" Dia. x 7 3/4" H (28.6 x 19.7 cm)

### Replacement Parts for JUICE3

- JFAUC5** Faucet
- JCOV3** Stainless Steel Cover
- JTUBE3** Stainless Steel Ice Tube with Inset
- JREP4** Plastic Body with Faucet

### Replacement Parts for JUICE4

- JFAUC5** Faucet
- JCOV4** Stainless Steel Cover
- JTUBE4** Stainless Steel Ice Tube with Inset
- JREP5** Plastic Body with Faucet







JBASEA8 shown with JUICE6

NEW



TOP DISPENSER CAN BE USED ON ITS OWN

**Stacking Dual Juice Dispenser** NEW

Serve up two beverage choices at the same time with this cleverly designed stacking juice dispenser. Made of extra strong polycarbonate, each section offers ample capacity for your largest crowds. Use them together or use the top dispenser on its own for a different look. Pair with bases in different finishes to create a look perfectly suited to your venue.

**JUICE6** Dispensers (1) 9.5 qt. (9 L) and (1) 15 qt. (14.2 L)  
 11 3/4" L x 9 3/4" W x 25 3/4" H  
 (29.8 x 24.8 x 65.4 cm)



JBASEM9 shown with JUICE6

NEW

**Acacia Wood Juice Dispenser Base** NEW

Add a rustic touch to your beverage station with this attractive acacia wood juice base! Space-saving knockdown design allows for easy storage.

**JBASEA8** Fits with JUICE6  
 11 7/8" L x 11 7/8" W x 7 3/4" H  
 (30.2 x 30.2 x 19.7 cm)

**Upton Collection Juice Dispenser Base** NEW

This juice dispenser base has a rich espresso color that adds timeless splendor to any buffet. Built in metal liner protects wood from potential moisture.

**JBASEM9** Fits with JUICE6  
 11" Dia. x 8 7/8" H  
 (27.9 x 22.5 cm)

**WARNING:** This product can expose you to chemicals including Bisphenol A (BPA), which is known to the State of California to cause birth defects or other reproductive harm. For more information, go to [www.P65warnings.ca.gov](http://www.P65warnings.ca.gov). Warning applies to State of California only.

**Dual Juice Dispenser** ⚠️

This clever, doubly functional piece comes complete with polycarbonate body, faucets, cover, ice tubes and grated base.

**JUICE12** Dispensers (2) 5.3 qt. (5 L)  
17" L x 13 ½" W x 21" H  
(43.2 x 34.3 x 53.3 cm)

**Replacement Parts**

**JFAUC8** Faucet  
**JSTRN12** Strainer  
**JCOV12** Cover  
**JTUBE12** Dual Ice Tubes  
**JBOD12** Dual Polycarbonate Bodies

**Mini Juice Dispenser** ⚠️

Comes complete with polycarbonate body, faucet, cover, ice tube and grated base.

**JUICE5** Dispenser, 5.3 qt. (5 L)  
16" L x 9" W x 14" H  
(40.6 x 22.9 x 35.6 cm)

**Replacement Parts**

**JSTRN8** Strainer  
**JCOV8** Cover  
**JFAUC8** Faucet  
**JTUBE8** Ice Tube  
**JBOD5** Polycarbonate Body



**WARNING:** This product can expose you to chemicals including Bisphenol A (BPA), which is known to the State of California to cause birth defects or other reproductive harm. For more information, go to [www.P65warnings.ca.gov](http://www.P65warnings.ca.gov). Warning applies to State of California only.





## Juice Dispensers

Retro and sleek, these pieces come with polycarbonate bodies, faucets, covers, ice tubes and grated bases.

**JUICE1** Dispenser, 8 ½ qt. (8 L)  
14 ¼" L x 10 ¼" W x 22" H  
(36.2 x 26 x 55.9 cm)

**JUICE2** Dispensers, (2) 8 ½ qt. (8 L)  
20" L x 10 ¼" W x 22" H  
(50.8 x 26 x 55.9 cm)

### Replacement Parts

- JSTRN6** Strainer
- JCOV1** Cover
- JTUBE5** Stainless Steel Ice Tube
- JFAUC4** Faucet
- JREP3** Polycarbonate Body



 **WARNING:** This product can expose you to chemicals including Bisphenol A (BPA), which is known to the State of California to cause birth defects or other reproductive harm. For more information, go to [www.P65warnings.ca.gov](http://www.P65warnings.ca.gov). Warning applies to State of California only.



### Allegro Coffee Urns

These 12 qt. (11.4 L) stainless steel urns feature a stylish faucet and a fuel holder. 11 1/8" Dia. x 19 3/4" H (28.3 x 50.2 cm).

**ALLEGUCU1** Gold Legs

**ALLEGUCU2** Stainless Steel Legs

### Allegro Coffee Urn Accessories

**AFAUC1** Faucet

### Drip Trays

These stainless steel drip trays keep buffet spaces clean without sacrificing aesthetics.

**DT3** Round  
5 1/2" Dia. x 1/2" H (14 x 1.3 cm)

**DT4** Square  
6" Sq. x 1/2" H (15.2 x 1.3 cm)







BLHT6

BLHT1

BLHP10

BLHF10

BLHSS10

BLHSP10

BLHML

BLHT2

BLHSS

BLHSP

BLHSA10

BLHSP6



BVHT1

BVHF10

BVHSP10

BVHT2

BVHSP

BVHF

BVHSP6

BVHT6

BVHP10

BVHSS10

BVHML

BVHSS

BVHL

BVHSA10



Black  
(BL)

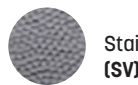

Stainless Steel  
(SV)



Bronze  
(BV)

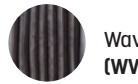

Wavy Aged  
(WV)



Gold  
(GV)

Available in five classic finishes

DISHWASHER-SAFE  
VIBRANT COLOR

### Vintage Hammered Buffetware

Make a statement with our vintage finish buffetware. Elevate your next buffet service with these classically inspired accessories. Will patina with use. Color may vary slightly.

#### Black

- BLHT6** 6" L Serving Tongs (15.2 cm)
- BLHT1** 9" L Serving Tongs (22.9 cm)
- BLHP10** 10" L Pie Server (25.4 cm)
- BLHF10** 10" L Cold Meat Fork (25.4 cm)
- BLHSS10** 10" L Slotted Spoon (25.4 cm)
- BLHSP10** 10" L Solid Spoon (25.4 cm)
- BLHML** 1 ½ oz., 11 ½" L Ladle (44.4 mL, 29.2 cm)
- BLHT2** 11 ¾" L Serving Tongs (29.8 cm)
- BLHSS** 13 ¼" L Slotted Spoon (33.7 cm)
- BLHSP** 13 ¼" L Solid Spoon (33.7 cm)
- BLHSA10** ½ oz., 9 ⅜" L Salad Spoon (14.8 mL, 23.8 cm)
- BLHSP6** 6 ⅝" L Spreader (16.8 cm)

#### Bronze

- BVHT6** 6" L Serving Tongs (15.2 cm)
- BVHT1** 9" L Serving Tongs (22.9 cm)
- BVHP10** 10" L Pie Server (25.4 cm)
- BVHF10** 10" L Cold Meat Fork (25.4 cm)
- BVHSS10** 10" L Slotted Spoon (25.4 cm)
- BVHSP10** 10" L Solid Spoon (25.4 cm)
- BVHML** 1 ½ oz., 11 ½" L Ladle (44.4 mL, 29.2 cm)
- BVHT2** 11 ¾" L Serving Tongs (29.8 cm)
- BVHSS** 13 ¼" L Slotted Spoon (33.7 cm)
- BVHSP** 13 ¼" L Solid Spoon (33.7 cm)
- BVHL** 3 ½ oz., 13" L Ladle (103.5 mL, 33 cm)
- BVHF** 13" L Cold Meat Fork (33 cm)
- BVHSA10** ½ oz., 9 ⅜" L Salad Spoon (14.8 mL, 23.8 cm)
- BVHSP6** 6 ⅝" L Spreader (16.8 cm)

**Gold**

- GVHT6** 6" L Serving Tongs (15.2 cm)
- GVHT1** 9" L Serving Tongs (22.9 cm)
- GVHP10** 10" L Pie Server (25.4 cm)
- GVHF10** 10" L Cold Meat Fork (25.4 cm)
- GVHSS10** 10" L Slotted Spoon (25.4 cm)
- GVHSP10** 10" L Solid Spoon (25.4 cm)
- GVHML** 1½ oz., 11½" L Ladle (44.4 mL, 29.2 cm)
- GVHT2** 11¾" L Serving Tongs (29.8 cm)
- GVHSS** 13¼" L Slotted Spoon (33.7 cm)
- GVHSP** 13¼" L Solid Spoon (33.7 cm)
- GVHL** 3½ oz., 13" L Ladle (103.5 mL, 33 cm)
- GVHF** 13" L Cold Meat Fork (33 cm)
- GVHSA10** ½ oz., 9¾" L Salad Spoon (14.8 mL, 23.8 cm)
- GVHSP6** 6⅝" L Spreader (16.8 cm)



**Stainless Steel**

- SVHT6** 6" L Serving Tongs (15.2 cm)
- SVHT1** 9" L Serving Tongs (22.9 cm)
- SVHP10** 10" L Pie Server (25.4 cm)
- SVHF10** 10" L Cold Meat Fork (25.4 cm)
- SVHSS10** 10" L Slotted Spoon (25.4 cm)
- SVHSP10** 10" L Solid Spoon (25.4 cm)
- SVHML** 1½ oz., 11½" L Ladle (44.4 mL, 29.2 cm)
- SVHT2** 11¾" L Serving Tongs (29.8 cm)
- SVHSS** 13¼" L Slotted Spoon (33.7 cm)
- SVHSP** 13¼" L Solid Spoon (33.7 cm)
- SVHL** 3½ oz., 13" L Ladle (103.5 mL, 33 cm)
- SVHF** 13" L Cold Meat Fork (33 cm)
- SVHSA10** ½ oz., 9¾" L Salad Spoon (14.8 mL, 23.8 cm)
- SVHSP6** 6⅝" L Spreader (16.8 cm)

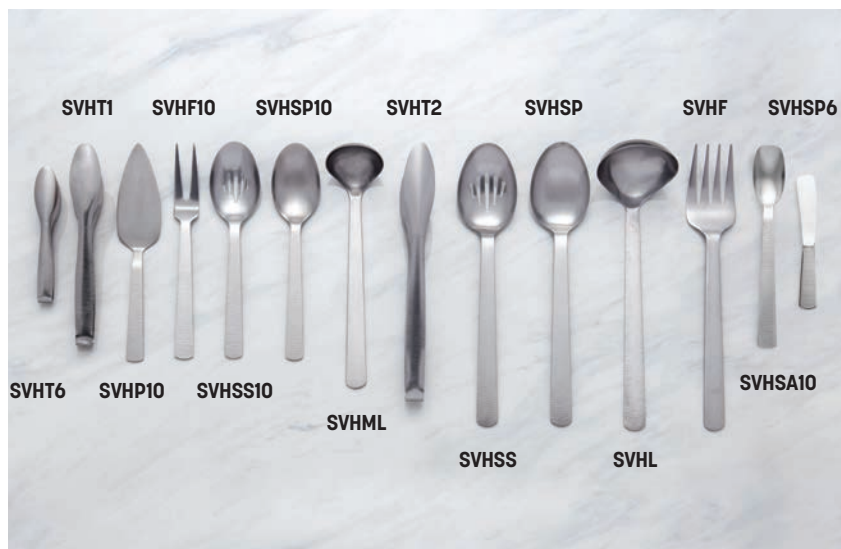

**Wavy Aged Stainless Steel**

- WVAT6** 6" L Serving Tongs (15.2 cm)
- WVAT1** 9" L Serving Tongs (22.9 cm)
- WVAP10** 10" L Pie Server (25.4 cm)
- WVAF10** 10" L Cold Meat Fork (25.4 cm)
- WVASS10** 10" L Slotted Spoon (25.4 cm)
- WVASP10** 10" L Solid Spoon (25.4 cm)
- WVAML** 1½ oz., 11½" L Ladle (44.4 mL, 29.2 cm)
- WVAT2** 11¾" L Serving Tongs (29.8 cm)
- WVASS** 13¼" L Slotted Spoon (33.7 cm)
- WVASP** 13¼" L Solid Spoon (33.7 cm)
- WVAL** 3½ oz., 13" L Ladle (103.5 mL, 33 cm)
- WVAF** 13" L Cold Meat Fork (33 cm)
- WVASA10** ½ oz., 9¾" L Salad Spoon (14.8 mL, 23.8 cm)
- WVASP6** 6⅝" L Spreader (16.8 cm)







**NEW**

SHFL9

SHFPS11

SHFSS12

SHFF12



SHFSA9



SHFSP7



SHFT6



SHFT9



SHFSP12



**NEW**

EACH PIECE FEATURES  
ONE-OF-A-KIND HANDMADE  
WORKMANSHIP

**Amano Buffetware** **NEW**

The Amano Collection is the perfect union of contemporary flair and handmade workmanship. Each piece is hand forged of durable stainless steel for a unique yet sophisticated look.

- SHFT6 6 3/8" L Serving Tongs (16.2 cm)
- SHFT9 9" L Serving Tongs (22.9 cm)
- SHFT11 11 3/4" L Serving Tongs (29.8 cm)
- SHFF12 12" L Cold Meat Fork (30.5 cm)
- SHFPS11 11" L Pastry Server (27.9 cm)
- SHFL9 1 oz., 9" L Ladle (29.6 mL, 22.9 cm)
- SHFSA9 3/4 oz., 9 3/8" L Salad Spoon (22.2 mL, 23.8 cm)
- SHFSS12 12" L Slotted Spoon (30.5 cm)
- SHFSP12 12" L Solid Spoon (30.5 cm)
- SHFSP7 7" L Spreader (17.8 cm)



**Hammered Buffet Portioned Servers**

With size-marked handles, these pieces are perfect wherever nutritional requirements need to be met.

- HMMS18** 1/8-Cup, 11 1/2" L Overall (29.6 mL, 29.2 cm)
- HMMS14** 1/4-Cup, 12" L Overall (59.1 mL, 30.5 cm)
- HMMS13** 1/3-Cup, 12 3/4" L Overall (78.8 mL, 32.4 cm)
- HMMS12** 1/2-Cup, 13" L Overall (118.3 mL, 33 cm)
- HMMS10** 1 Cup, 14" L Overall (236.6 mL, 35.6 cm)

**Hammered Buffetware**

Hammered stainless steel and inspired designs are time-honored ways of dressing up any buffet.

- HM6TNG** 6" L Serving Tongs (15.2 cm)
- HM8TNG** 8" L Serving Tongs (20.3 cm)
- HM11CMF** 11" L Cold Meat Fork (27.9 cm)
- HM11FK** 11" L Two-Tined Fork (27.9 cm)
- HM12PAS** 11" L Pastry Server (27.9 cm)
- HM14KN** 14" L Serrated Knife (35.6 cm)
- HM1LAD** 1 oz., 9" L Ladle (29.6 mL, 22.9 cm)
- HM9SPN** 1/4 oz., 9 1/2" L Salad Spoon (7.4 mL, 24.1 cm)
- HM12SL** 12" L Slotted Spoon (30.5 cm)
- HM12SOL** 12" L Solid Spoon (30.5 cm)
- HM12NOT** 12" L Notched Spoon (30.5 cm)
- HM10SPO** 10" L Solid Spoon (25.4 cm)
- HM10SL** 10" L Slotted Spoon (25.4 cm)







SW12PAS

SW6TNG

SW9TNG

SWILAD

SW9SPN



SW10SPO

SW12SOL

SW12SL

ITS6

PTS9

PTC8

### Mirage™ Buffetware

These stainless steel serving pieces come in an extensive collection for exceptional presentation consistency.

- SW12PAS** 11" L Pastry Server (27.9 cm)
- SW6TNG** 6" L Tongs (15.2 cm)
- SW9TNG** 9" L Tongs (22.9 cm)
- SWILAD** 1 oz., 9" L Ladle (29.6 mL, 22.9 cm)
- SW9SPN** ½ oz., 9 ½" L Salad Spoon (14.8 mL, 24.1 cm)
- SW10SPO** 10" L Solid Spoon (25.4 cm)
- SW12SOL** 12" L Solid Spoon (30.5 cm)
- SW12SL** 12" L Slotted Spoon (30.5 cm)
- ITS6** 6" L Ice Tongs (15.2 cm)
- PTS9** 8" L Serving Tongs (20.3 cm)
- PTC8** 8" L Pasta Tongs (20.3 cm)



**Belaire™ Hollow Handle Buffetware**

This collection features mirror-finished stainless steel, one-piece hollow handle construction and an ergonomic finger grip design.

- SLL1** 1 oz., 11" L Spout Ladle (29.6 mL, 27.9 cm)
- SLL2** 2 oz., 12" L Spout Ladle (59.1 mL, 30.5 cm)
- SPT14** 14" L Perforated Turner (35.6 cm)
- SPS11** 11" L Pie Server (27.9 cm)
- SLP121** 12" L Slotted Spoon (30.5 cm)
- SSP120** 12" L Solid Spoon (30.5 cm)
- SLL6** 6 oz., 12" L Ladle (177.4 mL, 30.5 cm)
- SLL4** 4 oz., 12" L Ladle (118.3 mL, 30.5 cm)







TONG3



TONG2

### Salad Scissor Tongs

**TONG3** Tong, Spoon/Spatula Design  
10" L (25.4 cm)

**TONG2** Tong, Spoon/Three-Tine Fork Design  
10" L (25.4 cm)



TG8

TGP8

### Serving Tongs

**TG8** Solid  
8 1/2" L x 2 1/2" W x 2 1/2" H  
(21.6 x 6.4 x 6.4 cm)

**TGP8** Perforated  
8 1/2" L x 2 1/2" W x 2 1/2" H  
(21.6 x 6.4 x 6.4 cm)

### Evolution Stainless Steel Tongs

Designed with ergonomics and contemporary design in mind, these tongs come in a range of sizes for every use.

**TGS8** 7 1/4" L (18.4 cm)

**TGS6** 6" L (15.2 cm)

**TGS9** 9 1/2" L (24.1 cm)

**TGS12** 12" L (30.5 cm)



TGS8



TGS6

TGS9

TGS12

### Evolution Cheese Knives

Clean lines and satin stainless steel make these knives the most stylish way to serve all manner of cheeses.

- CKNF6** Hard Cheese Knife  
9" L (22.9 cm)
- CKNF3** Fork-Tipped Hard Cheese Knife  
9" L (22.9 cm)
- CKNF5** Soft Cheese Knife  
9" L (22.9 cm)
- CKNF4** Hard Cheese Knife  
5 ¼" L (13.3 cm)
- CKNF7** Soft Cheese Spreader  
6 ⅝" L (16.8 cm)
- CKNF1** Flat Cheese Knife  
5 ¼" L (13.3 cm)
- CKNF2** Semi-Hard Cheese Knife  
5 ¼" L (13.3 cm)
- CKNF8** Hard Cheese Fork  
5 ¼" L (13.3 cm)



### Olive Wood Cheese Knives

Beautifully grained olive wood handles provide contrast to the mirror-finished stainless blades of these expertly crafted cheese knives. Pair with an Olive Wood Serving Board to complete the look.

- CKOW7** Soft Cheese Spreader  
5" L (12.7 cm)
- CKOW3** Hard Cheese Knife  
6" L (15.2 cm)
- CKOW2** Semi-Hard Cheese Knife  
4 ¾" L (12.1 cm)
- CKOW4** Hard Cheese Knife  
5" L (12.7 cm)
- CKOW8** Hard Cheese Fork  
5" L (12.7 cm)
- CKOW1** Hard Cheese Knife  
5" L (12.7 cm)







CER19

CER21

CER23



CER15



**THE PRESTIGE™ CERAMIC COLLECTION**

The unique shapes of these bowls and platters add fun and intrigue to anything you serve in them.

**Rectangular Ceramic Platters**

- CER19** 14" L x 7 1/2" W x 2" H  
(35.6 x 19.1 x 5.1 cm)
- CER23** 18 1/4" L x 9 1/4" W x 2 3/4" H  
(46.4 x 23.5 x 7 cm)
- CER21** 21" L x 12 3/4" W x 3 1/4" H  
(53.3 x 32.4 x 8.3 cm)

**Square Ceramic Platter**

- CER15** 14" Sq. x 1 1/2" H  
(35.6 x 3.8 cm)

**Wavy Ceramic Platters**

- RTWVY1** 14 3/8" L x 8 3/4" W x 1 1/8" H  
(36.5 x 22.2 x 2.9 cm)
- CER25** 21 3/4" L x 14 1/8" W x 2" H  
(55.2 x 35.9 x 5.1 cm)

**Squoval™ Ceramic Bowls**

- SQVL712** 37 oz. (1.1 L)  
12" L x 7" W x 2 3/4" H  
(30.5 x 17.8 x 7 cm)
- SQVL914** 71 oz. (2.1 L)  
14" L x 9" W x 3 1/4" H  
(35.6 x 22.9 x 8.3 cm)





Shown with an AWRS riser set



### Round Ceramic Bowls

- CER5** 40 oz. (1.2 L)  
8 1/2" Dia. x 3 1/4" H (21.6 x 8.3 cm)
- CER7** 60 oz. (1.8 L)  
12" Dia. x 3 1/4" H (30.5 x 8.3 cm)
- CER9** 180 oz. (5.3 L)  
17" Dia. x 5" H (43.2 x 12.7 cm)

### Squound™ Ceramic Bowls and Sauce Cups

- SQSC15** 1 1/2 oz. (44.4 mL)  
2 3/4" Dia. x 1" H (7 x 2.5 cm)
- SQSC20** 2 oz. (59.1 mL)  
3" Dia. x 1" H (7.6 x 2.5 cm)
- SQSC30** 3 oz. (88.7 mL)  
3 1/2" Dia. x 1 1/4" H (8.9 x 3.2 cm)
- SQSC40** 4 oz. (118.3 mL)  
4" Dia. x 1 1/2" H (10.2 x 3.8 cm)
- SQND7** 20 oz. (591.5 mL)  
7" Dia. x 2 7/8" H (17.8 x 7.3 cm)
- SQND9** 44 oz. (1.3 L)  
9" Dia. x 3 1/4" H (22.9 x 8.3 cm)
- SQND11** 76 oz. (2.2 L)  
10 3/4" Dia. x 4 1/8" H (27.3 x 10.5 cm)
- SQND13** 122 oz. (3.6 L)  
13" Dia. x 4 1/2" H (33 x 11.4 cm)
- SQND15** 208 oz. (6.2 L)  
15" Dia. x 5 1/2" H (38.1 x 14 cm)





### THE PRESTIGE™ PORCELAIN COLLECTION

The elegance of porcelain meets the playful profiles of our Prestige Collection, making this wide range of pieces extraordinarily versatile.

#### Square Porcelain Bowls and Sauce Cups

- CSC15** 1½ oz. (44.4 mL)  
1" Sq. x 1½" H (2.5 x 2.9 cm)
- CSC20** 2 oz. (59.1 mL)  
2½" Sq. x 1⅜" H (6.4 x 3.5 cm)
- WFB3** 3 oz. (88.7 mL)  
3" Sq. x 1⅝" H (7.6 x 4.1 cm)
- SQB55** 13 oz. (384.5 mL)  
4⅞" Sq. x 2¾" H (12.4 x 7 cm)
- WFB6** 24 oz. (709.8 mL)  
6" Sq. x 2⅞" H (15.2 x 6.7 cm)
- SQB88** 48 oz. (1.4 L)  
8¼" Sq. x 2½" H (21 x 6.4 cm)
- WFB9** 85 oz. (2.5 L)  
9" Sq. x 4" H (22.9 x 10.2 cm)
- WFB12** 193 oz. (5.7 L)  
12" Sq. x 5" H (30.5 x 12.7 cm)

#### Shallow Porcelain Bowls

- POR9** Square  
72 oz. (2.1 L)  
9¾" Sq. x 2¾" H  
(24.8 x 7 cm)
- POR17** Rectangular  
144 oz. (4.3 L)  
17¾" L x 9¾" W x 2¾" H  
(45.1 x 24.8 x 7 cm)







### Squavy™ Porcelain Bowls and Sauce Cups

- SQVY1** 1½ oz. (44.4 mL)  
2¼" Sq. x 1½" H (5.7 x 3.8 cm)
- SQVY2** 2½ oz. (73.9 mL)  
2½" Sq. x 1⅝" H (6.4 x 4.1 cm)
- SQVY3** 5 oz. (147.9 mL)  
3½" Sq. x 1⅞" H (8.9 x 4.8 cm)
- SQVY4** 15 oz. (443.6 mL)  
4½" Sq. x 2½" H (11.4 x 6.4 cm)
- SQVY5** 25 oz. (739.3 mL)  
5½" Sq. x 3" H (14 x 7.6 cm)
- SQVY8** 87 oz. (2.6 L)  
8½" Sq. x 3¾" H (21.6 x 9.5 cm)
- SQVY10** 162 oz. (4.8 L)  
10½" Sq. x 4⅜" H (26.7 x 11.1 cm)
- SQVY12** 228 oz. (6.7 L)  
12" Sq. x 5" H (30.5 x 12.7 cm)

### Footed Porcelain Bowls

- PFB6** 24 oz. (709.8 mL)  
6" Dia. x 3⅝" H (15.2 x 7.9 cm)
- PFB8** 60 oz. (1.8 L)  
8" Dia. x 4¼" H (20.3 x 10.8 cm)
- PFB10** 124 oz. (3.7 L)  
10" Dia. x 5⅝" H (25.4 x 13 cm)



PORS140

FEATURES BUILT-IN SAUCE CUPS



PORS136

**Porcelain Trays with Built-In Sauce Cups**

**PORS136** 13" L x 6" W x 1/2" H  
(33 x 15.2 x 1.3 cm)

**PORS140** 13" L x 9" W x 1/2" H  
(33 x 22.9 x 1.3 cm)

**Porcelain Impression Plate**

**CSP4** 12 1/4" L x 11" W x 1" H  
(31.1 x 27.9 x 2.5 cm)



CSP4

**Rectangular Porcelain Platters**

**WLD11** 11 1/2" L x 4" W x 7/8" H  
(29.2 x 10.2 x 2.2 cm)

**WLD13** 13 1/2" L x 4 1/2" W x 1" H  
(34.3 x 11.4 x 2.5 cm)

**WLD15** 15 1/2" L x 5" W x 1 1/8" H  
(39.4 x 12.7 x 2.9 cm)



WLD15

WLD13

WLD11





STACKABLE FOR  
EASY STORAGE

PSPL8

PSPL12 shown with ACF125 card holder  
and TACA8WT mini chalk card

## Porcelain Serving Plates

Small bites, desserts, baked goods - pretty much everything looks good on these round porcelain serving plates. The crisp white color provides the perfect elegant backdrop for any culinary creation.

**PSPL8** 8" Dia. x 1 1/4" H  
(20.3 x 3.2 cm)

**PSPL12** 12" Dia. x 1 1/4" H  
(30.5 x 3.2 cm)

## Porcelain Serving Stands

Give pastries and baked goods a lift with these porcelain pedestal stands. Available in a variety of sizes and heights, each can be used together or on its own to provide added height to any dessert.

**PSP4** 4" Dia. x 3" H  
(10.2 x 7.6 cm)

**PSP8** 8" Dia. x 3 1/8" H  
(20.3 x 7.9 cm)

**PSP12** 12" Dia. x 5 1/4" H  
(30.5 x 13.3 cm)

## Black Matte Finish Porcelain Casseroles

The look of cast iron meets the durability and weight of porcelain. Smaller casseroles (20-24 oz.) are perfect for shared sides or warm desserts. Larger casseroles (64-104 oz.) work well at buffets.

**PBB9** 20 oz. (591.5 mL)  
7 1/4" L x 4 1/4" W x 2" H  
9 1/4" L with Handles  
(18.4 x 10.8 x 5.1, 23.5 cm)

**PBB09** 24 oz. (709.8 mL)  
8 1/8" L x 6" W x 2 1/2" H  
9 1/4" L with Handles  
(20.6 x 15.2 x 6.4, 23.5 cm)

**PBB8** 24 oz. (709.8 mL)  
6 1/2" Sq. x 2" H  
8 1/4" L with Handles  
(16.5 x 5.1, 21 cm)

**PBB13** 64 oz. (1.9 L)  
11 5/8" L x 10" W x 2" H  
13 1/2" L with Handles  
(29.5 x 25.4 x 5.1, 34.3 cm)

**PBB135** 104 oz. (3.1 L)  
10 1/2" L x 9 1/4" W x 3" H  
13 1/8" L with Handles  
(26.7 x 23.5 x 7.6, 33.3 cm)

**PBB12** 92 oz. (2.7 L)  
12 1/4" L x 9 3/4" W x 2 1/2" H  
(31.1 x 24.8 x 6.4 cm)



Shown with BLCHD1, BLCHBC1 card holders,  
TACA7WT mini chalk card and LFTD11 dome

PERFECT FOR BAKERIES, COFFEE  
SHOPS AND DISPLAY CASES

PSP4

PSP8

PSP12









## THE TRANSCUENCE COLLECTION

We don't say "breathtaking" lightly, but this collection demands it. These handcrafted resin serving vessels feature a rich marbled design. Food-safe and stain-resistant, they combine elegance with durability.

### Round Translucence Bowls and Platter

**WSBM11** Bowl  
84 ½ oz. (2.5 L)  
11 ½" Dia. x 3 ½" H  
(29.2 x 8.9 cm)

**WSP15** Platter  
74 ½ oz. (2.2 L)  
15 ¼" Dia. x 2 ⅞" H  
(38.7 x 5.4 cm)

**WSBL15** Bowl  
169 oz. (5 L)  
15 ¾" Dia. x 3 ½" H  
(40 x 8.9 cm)



### Oblong Translucence Bowls

**WSMB17** 47 ½ oz. (1.4 L)  
17 ¾" L x 4 ¾" W x 2 ⅝" H  
(45.1 x 12.1 x 6 cm)

**WSLB27** 169 oz. (5 L)  
27 ¼" L x 7 ½" W x 3 ⅜" H  
(69.2 x 19.1 x 8.6 cm)

### Rectangular Translucence Platter

**WSRT21** 21 ⅞" L x 9 ¾" W x 1 ⅞" H  
(53.7 x 24.8 x 4.1 cm)





### THE GLACIER™ GLASS COLLECTION

When it comes to our Glacier Collection, the beauty is in the details. These platters and bowls make every meal a social media-worthy moment.

#### Rectangular Green Glacier Platters

- BG159** 15" L x 9" W x 7/8" H  
(38.1 x 22.9 x 2.2 cm)
- BG189** 18" L x 9" W x 7/8" H  
(45.7 x 22.9 x 2.2 cm)
- BG1911** 19" L x 11" W x 7/8" H  
(48.3 x 27.9 x 2.2 cm)
- BG2113** 21" L x 13" W x 7/8" H  
(53.3 x 33 x 2.2 cm)

#### Round Glacier Bowls

##### Green Glass

- GBG14** 98 oz. (2.9 L)  
14" Dia. x 3" H  
(35.6 x 7.6 cm)
- GBG19** 128 oz. (3.8 L)  
18" Dia. x 3 1/2" H  
(45.7 x 8.9 cm)

##### Blue Glass

- GBB15** 98 oz. (2.9 L)  
14" Dia. x 3" H  
(35.6 x 7.6 cm)
- GBB20** 128 oz. (3.8 L)  
18" Dia. x 3 1/2" H  
(45.7 x 8.9 cm)







THE ORGANIC EDGES ON THESE RIMS ENHANCE THE NATURAL LOOK OF THESE PIECES

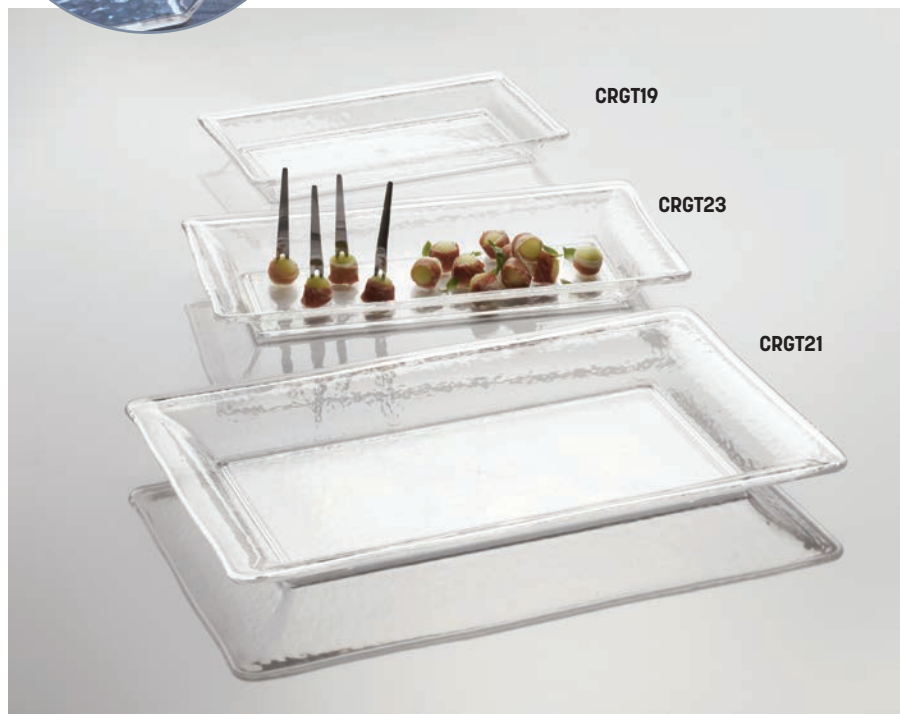

## THE RAIN COLLECTION

From organic edges to natural rain-splashed designs, every detail of these plastic platters and bowls is crafted with intent. And because it's lightweight to boot, the Rain Collection is as practical as it is beautiful.

### Square Rain Bowls

- CRGSQ53** 23 oz. (680.2 mL)  
5" Sq. x 2 7/8" H (12.7 x 7.3 cm)
- CRGSQ73** 58 oz. (1.7 L)  
7" Sq. x 3 1/4" H (17.8 x 8.3 cm)
- CRGSQ94** 125 oz. (3.7 L)  
9 1/2" Sq. x 4" H (24.1 x 10.2 cm)
- CRGSQ117** 228 oz. (6.7 L)  
12" Sq. x 4 1/2" H (30.5 x 11.4 cm)

### Rectangular Rain Platters

- CRGT19** 48 oz. (1.4 L)  
14" L x 7 1/2" W x 1 1/2" H  
(35.6 x 19.1 x 3.8 cm)
- CRGT23** 92 oz. (2.7 L)  
18 1/4" L x 9 1/4" W x 2" H  
(46.4 x 23.5 x 5.1 cm)
- CRGT21** 152 oz. (4.5 L)  
21" L x 13" W x 2" H  
(53.3 x 33 x 5.1 cm)



### THE ENDURANCE™ MELAMINE COLLECTION

If you need a collection that can stand the rigors of everyday performance, you're in the right place. These bowls, platters and plates are manufactured from highly durable melamine for long-lasting reliability. Not recommended for microwave use.

#### Shallow Melamine Bowls BPA FREE

- MELRC3** 10 oz. (295.7 mL)  
5 5/8" L x 3 3/8" W x 1 3/4" H  
(14.3 x 8.6 x 4.4 cm)
- MELSQ6** 16 oz. (473.2 mL)  
6" Sq. x 2" H (15.2 x 5.1 cm)
- MELSQ8** 36 oz. (1.1 L)  
8" Sq. x 2" H (20.3 x 5.1 cm)
- MELSQ10** 64 oz. (1.9 L)  
10" Sq. x 2" H (25.4 x 5.1 cm)

#### Shallow Round Melamine Bowls BPA FREE

Whether you serve poke bowls, açai bowls or regular old mac & cheese, these beautiful white pieces will present your creations with style.

- MELR5** 8 oz. (236.6 mL)  
5 1/4" Dia. x 1" H (13.3 x 2.5 cm)
- MELR6** 14 oz. (414 mL)  
6 5/8" Dia. x 1 3/8" H (16.8 x 3.5 cm)
- MELR8** 28 oz. (828.1 mL)  
8" Dia. x 1 3/4" H (20.3 x 4.4 cm)
- MELR9** 46 oz. (1.4 L)  
9 1/2" Dia. x 2 1/8" H (24.1 x 5.4 cm)
- MELR11** 86 oz. (2.5 L)  
11 1/4" Dia. x 2 3/8" H (28.6 x 6 cm)







### Rectangular

### Melamine Bowls HOT BPA FREE

- MLRP9** 48 oz. (1.4 L)  
9 3/4" L x 5 7/8" W x 2 3/4" H  
(24.8 x 14.9 x 7 cm)
- MLRP13** 136 oz. (4 L)  
13 3/4" L x 9 7/8" W x 2 3/4" H  
(34.9 x 25.1 x 7 cm)
- MLRP17** 233 oz. (6.9 L)  
17 5/8" L x 11 7/8" W x 2 3/4" H  
(44.8 x 30.2 x 7 cm)
- MLRP19** 157 oz. (4.6 L)  
19 5/8" L x 8" W x 3" H  
(49.8 x 20.3 x 7.6 cm)

### Square Melamine Bowls HOT BPA FREE

- MELSQ53** 23 oz. (680.2 mL)  
5" Sq. x 2 7/8" H  
(12.7 x 7.3 cm)
- MELSQ73** 58 oz. (1.7 L)  
7" Sq. x 3 1/4" H  
(17.8 x 8.3 cm)
- MELSQ94** 125 oz. (3.7 L)  
9 1/2" Sq. x 4" H  
(24.1 x 10.2 cm)
- MELSQ117** 208 oz. (6.2 L)  
12" Sq. x 4 1/2" H  
(30.5 x 11.4 cm)

### Oblong Melamine Bowls BPA FREE

These memorable oval-shaped bowls are perfectly sized for a variety of food presentations. Ideal for buffets and table service alike.

- MLRS9** 18 oz. (532.3 mL)  
9" L x 6" W x 1 3/4" H  
(22.9 x 15.2 x 4.4 cm)
- MLRS12** 42 oz. (1.2 L)  
12" L x 9" W x 2" H  
(30.5 x 22.9 x 5.1 cm)
- MLRS16** 64 oz. (1.9 L)  
16 7/8" L x 8 1/4" W x 2 3/8" H  
(42.9 x 21 x 6 cm)
- MLRS21** 194 oz. (5.7 L)  
21" L x 14" W x 2 7/8" H  
(53.3 x 35.6 x 7.3 cm)

### Angled Round Melamine Bowls BPA FREE

- MELSL52** 11 oz. (325.3 mL)  
5" Dia. x 3 1/4" H  
(12.7 x 8.3 cm)
- MELSL82** 40 oz. (1.2 L)  
8" Dia. x 5" H  
(20.3 x 12.7 cm)
- MELSL92** 64 oz. (1.9 L)  
9 1/4" Dia. x 5 1/4" H  
(23.5 x 13.3 cm)
- MELSL112** 112 oz. (3.3 L)  
12" Dia. x 6 1/2" H  
(30.5 x 16.5 cm)



MLRS12 shown inside MLRS21

MLRS9

MLRS16



MELSL92

MELSL112

MELSL82

MELSL52





FLRB95

FLRB8

FLRB11

**Flared Round Melamine Bowls** BPA FREE

- FLRB8 33 oz. (1 L)  
8" Dia. x 3 3/4" H (20.3 x 9.5 cm)
- FLRB95 54 oz. (1.6 L)  
9 1/2" Dia. x 4" H (24.1 x 10.2 cm)
- FLRB11 80 oz. (2.4 L)  
11" Dia. x 4 3/4" H (27.9 x 12.1 cm)

**Round Melamine Bowls** BPA FREE

- MEL5 57 oz. (1.7 L)  
8 1/2" Dia. x 3 3/8" H (21.6 x 8.6 cm)
- MEL7 87 oz. (2.6 L)  
12" Dia. x 3 3/4" H (30.5 x 9.5 cm)
- MEL9 270 oz. (8 L)  
17" Dia. x 4 7/8" H (43.2 x 12.4 cm)

**MEGA Melamine Bowl** BPA FREE

- MEL22 25 qt. (23.7 L)  
24" Dia. x 6" H (61 x 15.2 cm)



MEL9

FITS THE TTRS3  
STAND PG. 282



MEL7



MEL5



MEL22



**Crave Melamine Serveware** NSF BPA FREE

**Round Bowls**

- CBL78CL** Cloud, 78 oz. (2.3 L)  
9 1/2" Dia. x 3 5/8" H (24.1 x 9.2 cm)
- CBL78SH** Shadow, 78 oz. (2.3 L)  
9 1/2" Dia. x 3 5/8" H (24.1 x 9.2 cm)
- CBL185CL** Cloud, 185 oz. (5.5 L)  
13" Dia. x 4 1/2" H (33 x 11.4 cm)
- CBL185SH** Shadow, 185 oz. (5.5 L)  
13" Dia. x 4 1/2" H (33 x 11.4 cm)
- CBL325CL** Cloud, 10.2 qt. (9.6 L)  
16" Dia. x 5 1/4" H (40.6 x 13.3 cm)
- CBL325SH** Shadow, 10.2 qt. (9.6 L)  
16" Dia. x 5 1/4" H (40.6 x 13.3 cm)
- CBL54ST** Storm, 54 oz. (1.6 L)  
7 5/8" Dia. x 4 1/8" H (19.4 x 10.5 cm)
- CBL96SH** Shadow, 96 oz. (2.8 L)  
9 1/4" Dia. x 4 7/8" H (23.5 x 12.4 cm)
- CBL141CL** Cloud, 141 oz. (4.2 L)  
10 1/2" Dia. x 5 1/2" H (26.7 x 14 cm)

**Rectangular Platters**

- CPL14CL** Cloud  
14 1/4" L x 7 3/8" W x 1 3/8" H  
(36.2 x 18.7 x 3.5 cm)
- CPL14SH** Shadow  
14 1/4" L x 7 3/8" W x 1 3/8" H  
(36.2 x 18.7 x 3.5 cm)
- CPL21CL** Cloud  
21" L x 12 7/8" W x 2" H  
(53.3 x 32.7 x 5.1 cm)
- CPL21SH** Shadow  
21" L x 12 7/8" W x 2" H  
(53.3 x 32.7 x 5.1 cm)







### Melamine Serving Plates BPA FREE

Serve up your favorite pie on these versatile, durable and washable melamine serving plates. A sleek way to plate up any slice!

- MTP10** 10" Dia. x ¾" H (25.4 x 1.9 cm)
- MTP12** 12" Dia. x 1 ⅛" H (30.5 x 2.9 cm)
- MTP14** 14" Dia. x 1 ⅛" H (35.6 x 2.9 cm)
- MTP16** 16" Dia. x 1 ⅛" H (40.6 x 2.9 cm)
- MTP18** 18" Dia. x 1 ⅜" H (45.7 x 3.5 cm)

### Square Melamine Platters BPA FREE

- SQP10** 12" Sq. x 1 ⅜" H (30.5 x 3.5 cm)
- SQP12** 14" Sq. x 1 ½" H (35.6 x 3.8 cm)
- SQP16** 16" Sq. x 2" H (40.6 x 5.1 cm)

### Flat Melamine Platters BPA FREE

- MEL148** 14 ½" L x 8 ¼" W x ¾" H (36.8 x 21 x 1.9 cm)
- MEL189** 18 ¼" L x 9" W x ¾" H (46.4 x 22.9 x 1.9 cm)
- MEL1414** 14 ¾" Sq. x ¾" H (36.5 x 1.9 cm)
- MEL2113** 21 ½" L x 13" W x ¾" H (54.6 x 33 x 1.9 cm)





**Rectangular Melamine Platters**



- MEL12** 12" L x 7" W x 1 1/4" H  
(30.5 x 17.8 x 3.2 cm)
- MEL19** 14 1/8" L x 7 1/2" W x 1 1/2" H  
(35.9 x 19.1 x 3.8 cm)
- MEL23** 18 1/4" L x 9" W x 1 1/8" H  
(46.4 x 22.9 x 4.8 cm)
- MEL21** 21 5/8" L x 13" W x 1 7/8" H  
(54.9 x 33 x 4.8 cm)

**Disposable Liners**

- PBSL1** PET Liner for MEL19  
13 3/4" L x 7 1/4" W x 1" H  
(34.9 x 18.4 x 2.5 cm)
- PBSL2** PET Liner for MEL23  
17 1/2" L x 8 3/4" W x 2" H  
(44.5 x 22.2 x 5.1 cm)
- PBSL3** PET Liner for MEL21  
19 1/2" L x 12" W x 2" H  
(49.5 x 30.5 x 5.1 cm)

**Concave Melamine Platters**



- MEL44** Triangular  
17" L x 2 1/4" H  
(43.2 x 5.7 cm)
- MEL42** Square  
12" Sq. x 1 5/8" H  
(30.5 x 4.1 cm)
- MEL43** Square  
16" Sq. x 2" H  
(40.6 x 5.1 cm)

**Boat Melamine Platters**



- MEL49** 24" L x 9" W x 1 5/8" H  
(61 x 22.9 x 4.1 cm)
- MEL50** 28" L x 11 1/4" W x 1 1/2" H  
(71.1 x 28.6 x 3.8 cm)





FROM TOP  
TO BOTTOM:  
AWMEL19  
AWMEL23  
AWMEL21



DETAILED WITH ORGANIC EDGES,  
TEXTURED SURFACES AND MOTTLED ACCENTS



PORCELAIN LOOKS, MELAMINE DURABILITY

### Rectangular Antique White Melamine Platters BPA FREE

- AWMEL19** 14 1/4" L x 7 1/2" W x 1 1/2" H (36.2 x 19.1 x 3.8 cm)
- AWMEL23** 18" L x 8 1/4" W x 2" H (45.7 x 21 x 5.1 cm)
- AWMEL21** 21" L x 13" W x 2" H (53.3 x 33 x 5.1 cm)

### Square Antique White Melamine Bowls BPA FREE

- AWMSQ53** 23 oz. (680.2 mL)  
5" Sq. x 2 7/8" H (12.7 x 7.3 cm)
- AWMSQ73** 58 oz. (1.7 L)  
7" Sq. x 3 1/4" H (17.8 x 8.3 cm)
- AWMSQ94** 125 oz. (3.7 L)  
9 1/2" Sq. x 4" H (24.1 x 10.2 cm)
- AWMSQ117** 216 oz. (6.4 L)  
12" Sq. x 4 1/2" H (30.5 x 11.4 cm)



**Trapezoid Melamine Platters** BPA FREE

- TRPZ12** 12 1/2" L x 8 1/4" W x 1 1/2" H  
(31.8 x 21 x 3.8 cm)
- TRPZ18** 18 3/8" L x 8 1/8" W x 1 1/2" H  
(46.7 x 20.6 x 3.8 cm)
- TRPZ23** 22 7/8" L x 8 1/4" W x 1 1/2" H  
(58.1 x 21 x 3.8 cm)

**Rectangular Melamine Serving Trays** BPA FREE

Simple and versatile, these white melamine trays are as dapper as they are durable.

- TMW9** 9 3/8" L x 5 1/8" W x 3/4" H  
(23.8 x 13 x 1.9 cm)
- TMW13** 13 7/8" L x 6 1/2" W x 7/8" H  
(35.2 x 16.5 x 2.2 cm)
- TMW16** 16" L x 8" W x 1 1/8" H  
(40.6 x 20.3 x 2.9 cm)

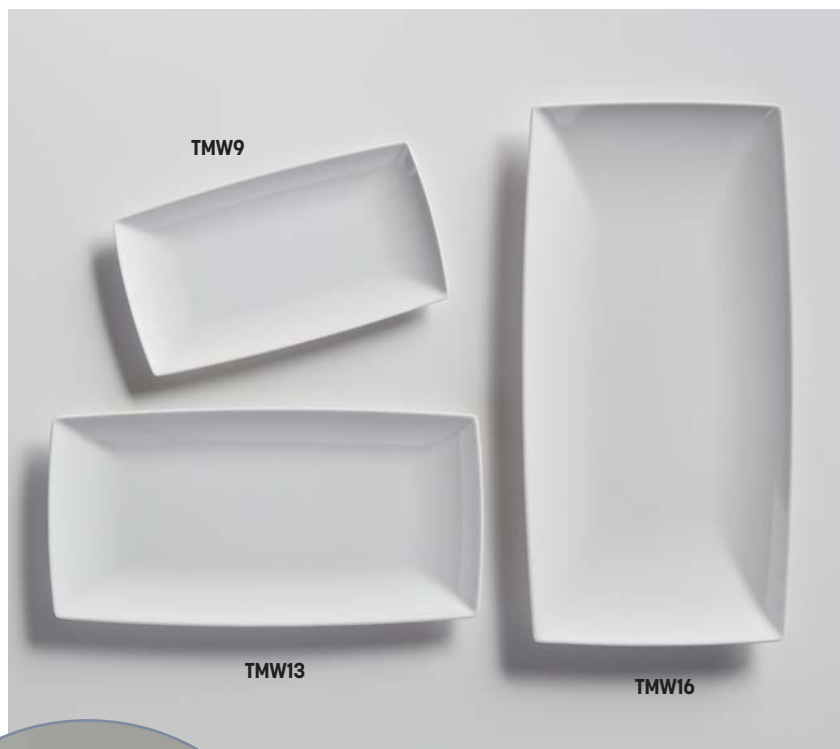

WORKS PERFECTLY IN HIGH-END SETTINGS





### Black Rimmed Rectangular Melamine Bowls BPA FREE

- MRCW6** 26 oz. (768.9 mL)  
6 7/8" L x 4 1/8" W x 3 1/4" H (17.5 x 10.5 x 8.3 cm)
- MRCW7** 44 oz. (1.3 L)  
6 3/8" L x 6 7/8" W x 3 1/4" H (16.2 x 17.5 x 8.3 cm)
- MRCW10** 64 oz. (1.9 L)  
10 3/8" L x 6 3/8" W x 3 1/4" H (26.4 x 16.2 x 8.3 cm)
- MRCW13** 82 oz. (2.4 L)  
12 3/8" L x 6 3/8" W x 3 1/4" H (32.1 x 17.1 x 8.3 cm)
- MRCW9** 98 oz. (2.9 L)  
9 3/4" Sq. x 3 1/4" H (24.8 x 8.3 cm)
- MRW615** 106 oz. (3.1 L)  
15" L x 6" W x 3 1/4" H (38.1 x 15.2 x 8.3 cm)
- MRCW12** 131 oz. (3.9 L)  
11 3/4" L x 10 3/8" W x 3 1/4" H (29.8 x 26.4 x 8.3 cm)
- MRW815** 144 oz. (4.3 L)  
15" L x 8" W x 3 1/4" H (38.1 x 20.3 x 8.3 cm)
- MRW1215** 212 oz. (6.3 L)  
15" L x 12" W x 3 1/4" H (38.1 x 30.5 x 8.3 cm)

### Black Rimmed Rectangular Melamine Platters HOT BPA FREE

- MRSW6** 6 7/8" L x 4 1/4" W x 1 1/8" H  
(17.5 x 10.8 x 2.9 cm)
- MRSW13** 12 3/4" L x 7" W x 1 1/8" H  
(32.4 x 17.8 x 2.9 cm)
- MRSW9** 9 7/8" Sq. x 1 1/8" H  
(25.1 x 2.9 cm)
- MRSW12** 12 7/8" L x 10 1/4" W x 1 1/8" H  
(32.7 x 26 x 2.9 cm)

Shown with PSP8 and PSP4 serving stands and GVHT1 tongs

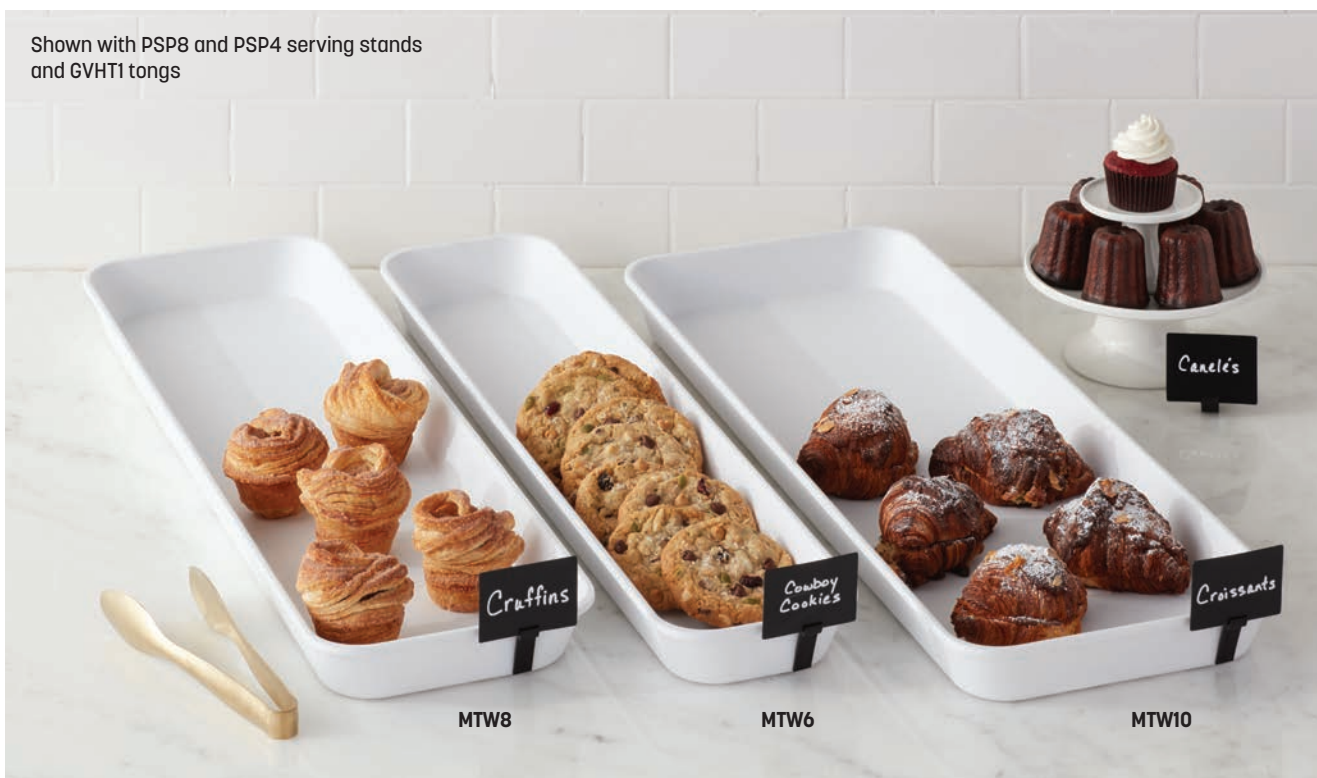

### Rectangular Market Trays BPA FREE

The perfect solution for deli cases everywhere, these large melamine trays beautifully display all types of food.

#### White

- MTW6** 150 oz. (4.4 L)  
29 3/4" L x 6 1/8" W x 2" H  
(75.6 x 15.6 x 5.1 cm)
- MTW8** 216 oz. (6.4 L)  
29 3/4" L x 8 1/2" W x 2" H  
(75.6 x 21.6 x 5.1 cm)
- MTW10** 270 oz. (8 L)  
29 3/4" L x 10 1/2" W x 2" H  
(75.6 x 26.7 x 5.1 cm)

#### Black

- MT6** 150 oz. (4.4 L)  
29 3/4" L x 6 1/8" W x 2" H  
(75.6 x 15.6 x 5.1 cm)
- MT8** 216 oz. (6.4 L)  
29 3/4" L x 8 1/2" W x 2" H  
(75.6 x 21.6 x 5.1 cm)
- MT10** 270 oz. (8 L)  
29 3/4" L x 10 1/2" W x 2" H  
(75.6 x 26.7 x 5.1 cm)







RCR21 cover shown on MREC21 platter

RCRD14 cover shown on MRDB14 bowl

RCR13 cover shown on MREC13 platter



RCRD14 cover shown on MRDB14 bowl

MTP14

Shown with MCB10MA cup, MCP6MA plate, HM8TNG tongs, HCHS1 card holder and TAGA8WT chalk card

## Covered Solutions

More freshness, less germs at your buffet station when you use one of our Covered Solutions. Each melamine platter or bowl pairs perfectly with a roll-top cover made of crystal clear polycarbonate. Pick your sizes and capacities to build the perfect display.

### Roll-Top Covers

- RCR13** Rectangular, Half-Size  
13 ¼" L x 10 ½" W x 6 ¼" H  
(33.7 x 26.7 x 15.9 cm)
- RCR21** Rectangular, Full-Size  
21" L x 13 ⅛" W x 7 ¼" H  
(53.3 x 33.3 x 18.4 cm)
- RCRD14** Round  
14 ½" Dia. x 7 ½" H  
(36.8 x 19.1 cm)

### Platters

- MREC13** Rectangular, Half-Size  
12 ¾" L x 10 ⅜" W x 1 ¼" H  
(32.4 x 26.4 x 3.2 cm)
- MREC21** Rectangular, Full-Size  
20 ⅞" L x 12 ¾" W x 1 ¼" H  
(53 x 32.4 x 3.2 cm)
- MTP14** Round  
14" Dia. x 1 ⅛" H  
(35.6 x 2.9 cm)

### Bowls

- MRECB13** Rectangular, Half-Size  
176 oz. (5.2 L)  
12 ¾" L x 10 ⅜" W x 4" H  
(32.4 x 26.4 x 10.2 cm)
- MRECB21** Rectangular, Full-Size  
328 oz. (9.7 L)  
20 ⅞" L x 12 ¾" W x 4" H  
(53 x 32.4 x 10.2 cm)
- MRDB14** Round, 278 oz. (8.2 L)  
14" Dia. x 5 ¼" H  
(35.6 x 13.3 cm)



**WARNING:** This product can expose you to chemicals including Bisphenol A (BPA), which is known to the State of California to cause birth defects or other reproductive harm. For more information, go to [www.P65warnings.ca.gov](http://www.P65warnings.ca.gov). Warning applies to State of California only.



RCR21 cover shown on MREC21 bowl

MREC21

Shown with WBP34 and WBC36 bottles, BLR14 drinkware, MCP6MA plates, HM8TNG tongs, HCHS1 card holder and TAGA8WT chalk card



RCR13 cover shown on MREC13 platter

MREC13

Shown with GSC6 shaker, GC8 carafe, MMP8 serving dish, HCHS1 card holder and TAGA8WT chalk card





## THE LIFT COLLECTION

Take your presentation to new heights with our Lift Collection. This family of bowls, plates, pedestals and domes is designed to quite literally elevate your culinary creations. They give your dishes a beautiful platform and draw your guests' attention to where it should be: the food. Buildable, durable and interchangeable, you might just find the Lift Collection indispensable.

### Lift Collection Bowls BPA FREE

#### White

- LFTBW8** 40 oz. (1.2 L)  
8 1/2" Dia. x 3 1/2" H (21.6 x 8.9 cm)
- LFTBW9** 68 oz. (2 L)  
9 7/8" Dia. x 4 1/2" H (25.1 x 11.4 cm)
- LFTBW11** 110 oz. (3.3 L)  
11 1/4" Dia. x 5 1/2" H (28.6 x 14 cm)

#### Black-Speckled

- LFTBB8** 40 oz. (1.2 L)  
8 1/2" Dia. x 3 1/2" H (21.6 x 8.9 cm)
- LFTBB9** 68 oz. (2 L)  
9 7/8" Dia. x 4 1/2" H (25.1 x 11.4 cm)
- LFTBB11** 110 oz. (3.3 L)  
11 1/4" Dia. x 5 1/2" H (28.6 x 14 cm)



FEATURES A TRENDY,  
SPECKLED DESIGN



## Lift Collection Plates BPA FREE

### White

**LFTPW11** 8 7/8" Dia. x 1" H (22.5 x 2.5 cm)

**LFTPW12** 11 3/4" Dia. x 1" H (29.8 x 2.5 cm)

**LFTPW13** 13" Dia. x 1" H (33 x 2.5 cm)

### Black-Speckled

**LFTPB11** 8 7/8" Dia. x 1" H (22.5 x 2.5 cm)

**LFTPB12** 11 3/4" Dia. x 1" H (29.8 x 2.5 cm)

**LFTPB13** 13" Dia. x 1" H (33 x 2.5 cm)

## Lift Collection Pedestals BPA FREE

### White

**LFTW63** 6 1/2" Dia. x 3 1/4" H (16.5 x 8.3 cm)

**LFTW65** 6 1/2" Dia. x 4 7/8" H (16.5 x 12.4 cm)

**LFTW67** 6 1/2" Dia. x 7 1/8" H (16.5 x 18.1 cm)

### Black

**LFTB63** 6 1/2" Dia. x 3 1/4" H (16.5 x 8.3 cm)

**LFTB65** 6 1/2" Dia. x 4 7/8" H (16.5 x 12.4 cm)

**LFTB67** 6 1/2" Dia. x 7 1/8" H (16.5 x 18.1 cm)

## Lift Collection Domes ⚠

**LFTD8** 8 1/8" Dia. x 6 5/8" H (20.6 x 16.8 cm)

**LFTD11** 11" Dia. x 8 5/8" H (27.9 x 21.9 cm)

**LFTD12** 12 1/8" Dia. x 9 1/8" H (30.8 x 23.2 cm)



**WARNING:** This product can expose you to chemicals including Bisphenol A (BPA), which is known to the State of California to cause birth defects or other reproductive harm. For more information, go to [www.P65warnings.ca.gov](http://www.P65warnings.ca.gov). Warning applies to State of California only.



Shown with BCH125 card holders

LFTBW12 shown with  
LFTB67 pedestal



LFTBW16



LFTBB12 shown with  
LFTW67 pedestal

LFTBB16

### Lift Collection Serving Bowls BPA FREE

Larger functions require larger capacities. Available in both 94 and 104 ounces, these generously-sized angled bowls are ideal for feeding the crowd. Give each bowl a "lift" with one of the collection's threaded pedestals (sold separately) and you are ready for the masses.

#### White

**LFTBW12** 94 oz. (2.8 L)  
12" Dia. x 4" H (30.5 x 10.2 cm)

**LFTBW16** 104 oz. (3.1 L)  
16" Dia. x 3" H (40.6 x 7.6 cm)

#### Black-Speckled

**LFTBB12** 94 oz. (2.8 L)  
12" Dia. x 4" H (30.5 x 10.2 cm)

**LFTBB16** 104 oz. (3.1 L)  
16" Dia. x 3" H (40.6 x 7.6 cm)

### Lift Collection Platters BPA FREE

Our Lift Collection plates now have big brothers. Amply sized to feed large groups, each platter offers the flexibility to be used with or without a pedestal (sold separately). Mix with the other plates and bowls in the line for a truly flexible and versatile presentation.

#### Black-Speckled

**LFTP22** 22" L x 12" W x 2 1/4" H  
(55.9 x 30.5 x 5.7 cm)

**LFTP24** 24" L x 9 1/2" W x 2 3/4" H  
(61 x 24.1 x 7 cm)

#### White

**LFTPW22** 22" L x 12" W x 2 1/4" H  
(55.9 x 30.5 x 5.7 cm)

**LFTPW24** 24" L x 9 1/2" W x 2 3/4" H  
(61 x 24.1 x 7 cm)

### Lift Collection

#### Tiered Stands NEW BPA FREE

Display your baked goods, light bites and more on this melamine tiered stand! Plates are available in multiple sizes so you can create a dynamic presentation. The melamine construction makes this stand highly durable - ideal for a catered event or busy establishment.

#### Black-Speckled

**LFTTSB17** 7 7/8" Dia. Small Plate (20 cm)  
9 7/8" Dia. Medium Plate (25.1 cm)  
12 5/8" Dia. Large Plate (32.1 cm)  
17 1/2" H (44.5 cm) Fully Assembled

#### White

**LFTTSW17** 7 7/8" Dia. Small Plate (20 cm)  
9 7/8" Dia. Medium Plate (25.1 cm)  
12 5/8" Dia. Large Plate (32.1 cm)  
17 1/2" H (44.5 cm) Fully Assembled

#### Replacement Rods

**LFTTSRRS** Stainless Steel

**LFTTSRRB** Black

CUSTOMIZE FOR A ONE-TIER, TWO-TIER OR THREE-TIER PRESENTATION. FEATURES PLATES WITH A REVERSIBLE DESIGN



Shown with BAMBL125, BAMBL4 card holders, TAGA7WT chalk cards, GGRW3 bowls and SLR3 lids

**LFTP24** shown with LFTW65 pedestal



**LFTPW24** shown with LFTB63 pedestal







## THE GRAB & GO COLLECTION

Pack it, stack it and grab it! This reusable collection was curated with reinvention of buffet and group dining in mind. Made of dishwasher-safe melamine and coordinating SAN lids, these bowls keep food safe from germs and contaminants.

### Round Bowls BPA FREE

#### White

- GGRW3** 4 oz. (118.3 mL)  
3 3/8" Dia. x 1 3/8" H (8.6 x 3.5 cm)
- GGRW5** 9 1/2 oz. (280.9 mL)  
4 7/8" Dia. x 1 7/8" H (12.4 x 4.8 cm)
- GGRW6** 18 oz. (532.3 mL)  
6" Dia. x 2 3/8" H (15.2 x 6 cm)
- GGRW8** 32 oz. (946.4 mL)  
8 1/2" Dia. x 2" H (21.6 x 5.1 cm)

#### Black-Speckled

- GGRB3** 4 oz. (118.3 mL)  
3 3/8" Dia. x 1 3/8" H (8.6 x 3.5 cm)
- GGRB5** 9 1/2 oz. (280.9 mL)  
4 7/8" Dia. x 1 7/8" H (12.4 x 4.8 cm)
- GGRB6** 18 oz. (532.3 mL)  
6" Dia. x 2 3/8" H (15.2 x 6 cm)
- GGRB8** 32 oz. (946.4 mL)  
8 1/2" Dia. x 2" H (21.6 x 5.1 cm)

#### Round Bowl Lids

- SLR3** Fits GGRW3 and GGRB3  
3 1/2" Dia. x 1" H (8.9 x 2.5 cm)
- SLR5** Fits GGRW5 and GGRB5  
5 1/8" Dia. x 1" H (13 x 2.5 cm)
- SLR6** Fits GGRW6 and GGRB6  
6 1/8" Dia. x 1" H (15.6 x 2.5 cm)
- SLR8** Fits GGRW8 and GGRB8  
8 1/2" Dia. x 1" H (21.6 x 2.5 cm)  
(not shown)



## Square Bowls BPA FREE

### White

**GGSW5** 12 ½ oz. (369.7 mL)  
5" Sq. x 1 ⅝" H (12.7 x 4.1 cm)

**GGSW6** 27 oz. (798.5 mL)  
6 ½" Sq. x 2 ⅞" H (16.5 x 5.4 cm)

### Black-Speckled

**GGSB5** 12 ½ oz. (369.7 mL)  
5" Sq. x 1 ⅝" H (12.7 x 4.1 cm)

**GGSB6** 27 oz. (798.5 mL)  
6 ½" Sq. x 2 ⅞" H (16.5 x 5.4 cm)

### Square Bowl Lids

**SLS5** Fits GGSW5 and GGSB5  
5" Sq. x 1" H (12.7 x 2.5 cm)

**SLS6** Fits GGSW6 and GGSB6  
6 ⅝" Sq. x 1" H (16.8 x 2.5 cm)



## Rectangular Bowls BPA FREE

### White

**GGW74** 17 oz. (502.8 mL)  
7" L x 4 ¼" W x 2 ⅞" H  
(17.8 x 10.8 x 5.4 cm)

**GGW76** 46 oz. (1.4 L)  
7" L x 6 ⅜" W x 3" H  
(17.8 x 16.2 x 7.6 cm)

**GGW96** 25 ½ oz. (754.1 mL)  
9" L x 6" W x 2" H  
(22.9 x 15.2 x 5.1 cm)

### Black-Speckled

**GGB74** 17 oz. (502.8 mL)  
7" L x 4 ¼" W x 2 ⅞" H  
(17.8 x 10.8 x 5.4 cm)

**GGB76** 46 oz. (1.4 L)  
7" L x 6 ⅜" W x 3" H  
(17.8 x 16.2 x 7.6 cm)

**GGB96** 25 ½ oz. (754.1 mL)  
9" L x 6" W x 2" H  
(22.9 x 15.2 x 5.1 cm)

### Rectangular Bowl Lids

**SL74** Fits GGW74 and GGB74  
7 ⅞" L x 4 ⅜" W x 1" H  
(18.1 x 11.1 x 2.5 cm)

**SL76** Fits GGW76 and GGB76  
7" L x 6 ½" W x 1" H  
(17.8 x 16.5 x 2.5 cm)

**SL96** Lid, Fits GGW96 and GGB96  
9" L x 6" W x 1" H  
(22.9 x 15.2 x 2.5 cm)  
(not shown)







**Oval Melamine Platters** BPA FREE

High-style oval serving shapes add depth and beauty to the buffet, offered in your choice of dual-tone matte black or matte white with a glossy white center. Made of sleek yet durable melamine, these oval platters offer ample room for serving anything from appetizers, salads to entrees.

**Black/White**

**NP14** 14" L x 9" W x 1 3/8" H  
(35.6 x 22.9 x 3.5 cm)

**NP18** 18" L x 12" W x 1 3/4" H  
(45.7 x 30.5 x 4.4 cm)

**NP21** 21 1/2" L x 14 3/8" W x 2" H  
(54.6 x 36.5 x 5.1 cm)

**White** NEW

**NPW14** 14" L x 9" W x 1 3/8" H  
(35.6 x 22.9 x 3.5 cm)

**NPW18** 18" L x 12" W x 1 3/4" H  
(45.7 x 30.5 x 4.4 cm)

**NPW21** 21 1/2" L x 14 3/8" W x 2" H  
(54.6 x 36.5 x 5.1 cm)

**Round Melamine Noodle Bowls** BPA FREE

Serve up today's global fare in our traditional yet contemporary noodle bowls. Featuring a sleek finish of matte black or matte white with a glossy white center and the most popular capacities, these bowls create a beautiful backdrop for your noodle creations. Also available in larger serving options.

**Black/White**

- NB30** 30 oz. (887.2 mL)  
6 ¾" Dia. x 3 ½" H (17.1 x 8.9 cm)
- NB32** 32 oz. (946.4 mL)  
8" Dia. x 3" H (20.3 x 7.6 cm)
- NB50** 50 oz. (1.5 L)  
7 ½" Dia. x 3 ⅞" H (19.1 x 9.8 cm)
- NB56** 56 oz. (1.7 L)  
10" Dia. x 3 ⅜" H (25.4 x 8.6 cm)
- NB85** 85 oz. (2.5 L)  
9" Dia. x 4 ½" H (22.9 x 11.4 cm)
- NB120** 120 oz. (3.5 L)  
10" Dia. x 5 ⅞" H (25.4 x 13 cm)

**White** NEW

- NBW30** 30 oz. (887.2 mL)  
6 ¾" Dia. x 3 ½" H (17.1 x 8.9 cm)
- NBW32** 32 oz. (946.4 mL)  
8" Dia. x 3" H (20.3 x 7.6 cm)
- NBW50** 50 oz. (1.5 L)  
7 ½" Dia. x 3 ⅞" H (19.1 x 9.8 cm)
- NBW56** 56 oz. (1.7 L)  
10" Dia. x 3 ⅜" H (25.4 x 8.6 cm)
- NBW85** 85 oz. (2.5 L)  
9" Dia. x 4 ½" H (22.9 x 11.4 cm)
- NBW120** 120 oz. (3.5 L)  
10" Dia. x 5 ⅞" H (25.4 x 13 cm)







## THE FAUX SLATE COLLECTION

It's easy to mistake our Faux Slate Collection for the real thing, but take another look and you'll discover that these gorgeous pieces are actually crafted from durable, washable melamine. Accessorize your tabletops with these unique bowls, platters and peels.

### White Square Faux Slate Melamine Bowls BPA FREE

- FSWMEL53** 23 oz. (680.2 mL)  
5" Sq. x 2 7/8" H (12.7 x 7.3 cm)
- FSWMEL73** 58 oz. (1.7 L)  
7" Sq. x 3 1/4" H (17.8 x 8.3 cm)
- FSWMEL94** 125 oz. (3.7 L)  
9 1/2" Sq. x 4" H (24.1 x 10.2 cm)
- FSWMEL117** 208 oz. (6.2 L)  
12" Sq. x 4 1/2" H (30.5 x 11.4 cm)

### White Faux Slate Flat Melamine Platters BPA FREE

- FSLW10** 10" L x 8 1/4" W x 1/4" H  
(25.4 x 21 x 0.6 cm)
- FSLW08** 14 3/4" L x 8 1/4" W x 1/4" H  
(37.5 x 21 x 0.6 cm)
- FSLW18** 18" L x 8 1/2" W x 1/4" H  
(45.7 x 21.6 x 0.6 cm)
- FSLW14** 14 1/2" Sq. x 1/4" H  
(36.8 x 0.6 cm)
- FSLW21** 21 1/2" L x 13" W x 1/4" H  
(54.6 x 33 x 0.6 cm)

FSMEL117



FSMEL94



FSMEL53



FSMEL73



**Black Square Faux Slate Melamine Bowls**

- FSMEL53 23 oz. (680.2 mL)  
5" Sq. x 2 7/8" H (12.7 x 7.3 cm)
- FSMEL73 58 oz. (1.7 L)  
7" Sq. x 3 1/4" H (17.8 x 8.3 cm)
- FSMEL94 125 oz. (3.7 L)  
9 1/2" Sq. x 4" H (24.1 x 10.2 cm)
- FSMEL117 208 oz. (6.2 L)  
12" Sq. x 4 1/2" H (30.5 x 11.4 cm)

**Black Faux Slate Flat Melamine Platters**

- FSLT10 10" L x 8 1/4" W x 1/4" H  
(25.4 x 21 x 0.6 cm)
- FSLT08 14 3/4" L x 8 1/4" W x 1/4" H  
(37.5 x 21 x 0.6 cm)
- FSLT18 18" L x 8 1/2" W x 1/4" H  
(45.7 x 21.6 x 0.6 cm)
- FSLT14 14 1/2" Sq. x 1/4" H  
(36.8 x 0.6 cm)
- FSLT21 21 1/2" L x 13" W x 1/4" H  
(54.6 x 33 x 0.6 cm)



**HOT**

FSLT08 shown with MICH25, MICH10 milk cans

USE WITH SECURIT MARKERS-EASY TO IDENTIFY, SIMPLE TO WIPE CLEAN. SEE PG. 321





### Black Faux Slate Melamine Platters BPA FREE

The chic texture of slate meets the durability of melamine with these stunning black trays, now with rims to help hold and showcase your latest menu creations.

- FSMEL12** 12" L x 7" W x 1½" H  
(30.5 x 17.8 x 3.8 cm)
- FSMEL19** 14" L x 7½" W x 1½" H  
(35.6 x 19.1 x 3.8 cm)
- FSMEL23** 18" L x 8¼" W x 2" H  
(45.7 x 21 x 5.1 cm)
- FSMEL21** 21" L x 13" W x 2" H  
(53.3 x 33 x 5.1 cm)

### Black Faux Slate Melamine Serving Peels BPA FREE

- FSR9** 9" Dia. x ⅝" H  
12 ⅝" L with Handle  
(22.9 x 1.6, 32.1 cm)
- FSR11** 12" Dia. x ⅝" H  
16 ¾" L with Handle  
(30.5 x 1.6, 42.5 cm)
- FSR14** 15" Dia. x ⅝" H  
20 ¾" L with Handle  
(38.1 x 1.6, 52.7 cm)



Shown with SVHT6 tongs

### THE MELAMINE NATURALS COLLECTION

At first glance, these boards look like real stone and wood serving pieces. But upon closer examination, they're actually crafted from durable, dishwasher-safe melamine.

#### White Marble Melamine Platters and Bowls BPA FREE

With an elegant marble finish, these bowls and platters are truly chic. They come in the same sizes as our traditional melamine bowls and platters with a modern shape.

- MWME12** 12" L x 7" W x 1 1/2" H  
(30.5 x 17.8 x 3.8 cm)
- MWME19** 14" L x 7 1/2" W x 1 1/2" H  
(35.6 x 19.1 x 3.8 cm)
- MWME23** 18" L x 8 1/4" W x 2" H  
(45.7 x 21 x 5.1 cm)
- MWME21** 21" L x 13" W x 2" H  
(53.3 x 33 x 5.1 cm)
- MWMSQ5** 19 oz. (561.9 mL)  
5" Sq. x 2 7/8" H (12.7 x 7.3 cm)
- MWMSQ7** 54 oz. (1.6 L)  
7" Sq. x 3 1/4" H (17.8 x 8.3 cm)
- MWMSQ9** 127 oz. (3.8 L)  
9 1/2" Sq. x 4" H (24.1 x 10.2 cm)
- MWMSQ11** 232 oz. (6.9 L)  
12" Sq. x 4 1/2" H (30.5 x 11.4 cm)



Shown with GVHT2 tongs





Shown with GVHT1 tongs

MWB14

MWB12

MWB11



MW32

NEW

MW24

MW18

### White Marble Melamine Serving Bowls

BPA FREE

With the look of high-end marble and the durability of melamine, these generously-sized serving bowls are made to be true crowd pleasers. From salads to sides, these bowls provide an elegant backdrop to any group dining event.

**MWB11** 97 oz. (2.9 L)  
11" Dia. x 3 1/8" H  
(27.9 x 7.9 cm)

**MWB12** 137 oz. (4.1 L)  
12 3/4" Dia. x 3 3/8" H  
(32.4 x 8.6 cm)

**MWB14** 235 oz. (6.9 L)  
14 3/4" Dia. x 3 1/2" H  
(37.5 x 8.9 cm)

### White Marble Flat Melamine Serving Platters

NEW

BPA FREE

Achieve the stately look of white marble on your buffet line or grazing table without compromising lightweight and dishwasher-safe convenience. These melamine platters are stunningly elegant and equally practical. They pair perfectly with our Black Twilight Modular Risers for a knockout presentation.

**MW18** 17 3/4" L x 8 3/4" W x 5/8" H  
(45.1 x 22.2 x 1.6 cm)

**MW24** 24" L x 8 3/4" W x 5/8" H  
(61 x 22.2 x 1.6 cm)

**MW32** 31 1/2" L x 8 3/4" W x 5/8" H  
(80 x 22.2 x 1.6 cm)

## Marble Melamine Serving Boards

### White

- MW17** Organic  
17 3/8" L x 9 7/8" W x 5/8" H  
(44.1 x 25.1 x 1.6 cm)
- MW14** Round  
14" Dia. x 1 1/8" H  
(35.6 x 2.9 cm)
- MW25** Oval  
25 1/2" L x 10 1/4" W x 1 1/8" H  
(64.8 x 26 x 2.9 cm)
- MW171** Round  
17 1/4" Dia. x 1 1/8" H  
(43.8 x 2.9 cm)
- MW21** Round  
21 1/2" Dia. x 1 1/8" H  
(54.6 x 2.9 cm)

### Black

- MB17** Organic  
17 3/8" L x 9 7/8" W x 5/8" H  
(44.1 x 25.1 x 1.6 cm)
- MB14** Round  
14" Dia. x 1 1/8" H  
(35.6 x 2.9 cm)
- MB25** Oval  
25 1/2" L x 10 1/4" W x 1 1/8" H  
(64.8 x 26 x 2.9 cm)
- MB171** Round  
17 1/4" Dia. x 1 1/8" H  
(43.8 x 2.9 cm)
- MB21** Round  
21 1/2" Dia. x 1 1/8" H  
(54.6 x 2.9 cm)

A PRACTICAL, STYLISH ALTERNATIVE  
TO REAL MARBLE

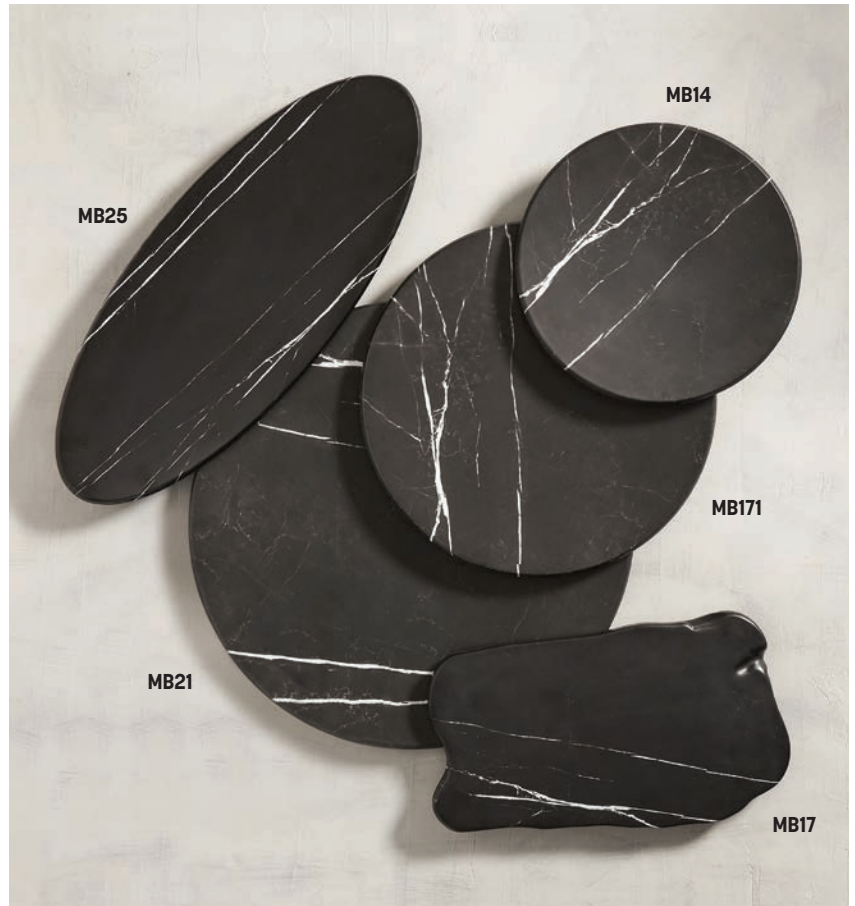





GM1614

GM210



GM147

GM189

GM2113

### Greystone Melamine Serving Boards

Your customers will swear that these melamine serving boards and risers are chiseled from stone.

- GM1614** Organic Round  
16 3/8" L x 14 5/8" W x 5/8" H  
(41.6 x 37.1 x 1.6 cm)
- GM210** Organic Oblong  
21 1/4" L x 10 5/8" W x 5/8" H  
(54 x 27 x 1.6 cm)
- GM147** Rectangular  
14 1/4" L x 8" W x 3/8" H  
(36.2 x 20.3 x 1 cm)
- GM189** Rectangular  
17 3/4" L x 8 3/4" W x 3/8" H  
(45.1 x 22.2 x 1 cm)
- GM2113** Rectangular  
21 3/8" L x 12 3/4" W x 3/8" H  
(54.3 x 32.4 x 1 cm)



GM95

GM13

### Greystone Melamine Risers

- GM95** Round  
10 1/8" Dia. x 2 1/8" H  
(25.7 x 5.4 cm)
- GM13** Rectangular  
12 1/4" L x 6 3/4" W x 2" H  
(31.1 x 17.1 x 5.1 cm)

**Olive Wood Melamine  
Serving Boards** 

**OWM17** Organic  
17 3/8" L x 9 7/8" W x 5/8" H  
(44.1 x 25.1 x 1.6 cm)

**OWM14** Round  
14" Dia. x 1 1/8" H  
(35.6 x 2.9 cm)

**OWM25** Oval  
25 1/2" L x 10 1/4" W x 1 1/8" H  
(64.8 x 26 x 2.9 cm)

**OWM171** Round  
17 1/4" Dia. x 1 1/8" H  
(43.8 x 2.9 cm)

**OWM21** Round  
21 1/2" Dia. x 1 1/8" H  
(54.6 x 2.9 cm)

**Olive Wood Melamine  
Serving Peels** 

**OWM12** Rectangular  
12" L x 6" W x 1/2" H  
17 1/2" L with Handle  
(30.5 x 15.2 x 1.3, 44.5 cm)

**OWM10** Square  
10" L x 9" W x 1/2" H  
14 1/2" L with Handle  
(25.4 x 22.9 x 1.3, 36.8 cm)







RMB14

RMB11

RMB12

Shown with GVHT2 tongs

## Reclaimed Wood Melamine

### Serving Bowls BPA FREE

We took the natural styling of our Reclaimed Wood Melamine Serving Boards and applied it to bowls, creating a great opportunity for cohesive presentation. The exterior of the bowls is wood-textured to complement the unique faux-weathered interior.

**RMB11** 97 oz. (2.9 L)  
11" Dia. x 3 1/8" H  
(27.9 x 7.9 cm)

**RMB12** 137 oz. (4.1 L)  
12 3/4" Dia. x 3 3/8" H  
(32.4 x 8.6 cm)

**RMB14** 235 oz. (6.9 L)  
14 3/4" Dia. x 3 1/2" H  
(37.5 x 8.9 cm)

## Reclaimed Wood Melamine

### Serving Boards BPA FREE

The on-trend look of reclaimed wood meets the durable functionality of melamine with our serving boards, peels and risers. All of the style, none of the impracticality.

**RM17** Organic  
17 3/8" L x 9 7/8" W x 5/8" H  
(44.1 x 25.1 x 1.6 cm)

**RM14** Round  
14" Dia. x 1 1/8" H  
(35.6 x 2.9 cm)

**RM25** Oval  
25 1/2" L x 10 1/4" W x 1 1/8" H  
(64.8 x 26 x 2.9 cm)

**RM21** Round  
21 1/2" Dia. x 1 1/8" H  
(54.6 x 2.9 cm)



RM14

RM25

RM21

RM17

## Reclaimed Wood Melamine

### Serving Peels BPA FREE

**RM12** Rectangular  
12" L x 6" W x 1/2" H  
17 1/2" L with Handle  
(30.5 x 15.2 x 1.3, 44.5 cm)

**RM10** Square  
10" L x 9" W x 1/2" H  
14 1/2" L with Handle  
(25.4 x 22.9 x 1.3, 36.8 cm)



RM12

RM10





**Reclaimed Wood  
Melamine Serving Boards** BPA  
FREE

- RM147** Rectangular  
14 1/4" L x 8" W x 3/8" H  
(36.2 x 20.3 x 1 cm)
- RM189** Rectangular  
17 3/4" L x 8 3/4" W x 3/8" H  
(45.1 x 22.2 x 1 cm)
- RM2113** Rectangular  
21 3/8" L x 12 3/4" W x 3/8" H  
(54.3 x 32.4 x 1 cm)
- RM1614** Organic Round  
16 3/8" L x 14 5/8" W x 5/8" H  
(41.6 x 37.1 x 1.6 cm)
- RM210** Organic Oblong  
21 1/4" L x 10 5/8" W x 5/8" H  
(54 x 27 x 1.6 cm)

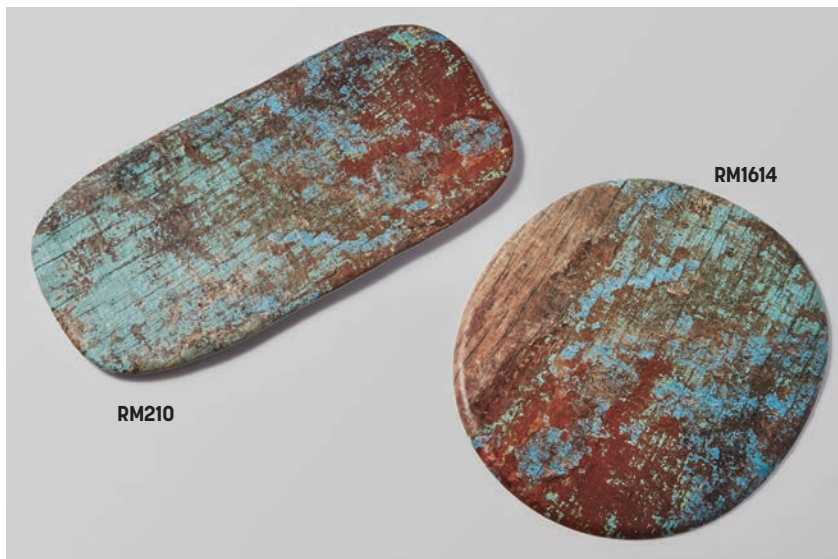

**Reclaimed Wood  
Melamine Risers** BPA  
FREE

- RM95** Round  
10 1/8" Dia. x 2 1/8" H  
(25.7 x 5.4 cm)
- RM13** Rectangular  
12 1/4" L x 6 3/4" W x 2" H  
(31.1 x 17.1 x 5.1 cm)







ROUND AND OVAL SERVING  
BOARDS FEATURE  
INCONSPICUOUS 1 1/8" FEET  
FOR CONVENIENT SERVING

PERFECT FOR FARM-TO-TABLE



### Acacia Melamine Serving Boards BPA FREE

- AWM17** Organic  
17 3/8" L x 9 7/8" W x 5/8" H  
(44.1 x 25.1 x 1.6 cm)
- AWM14** Round  
14" Dia. x 1 1/8" H  
(35.6 x 2.9 cm)
- AWM25** Oval  
25 1/2" L x 10 1/4" W x 1 1/8" H  
(64.8 x 26 x 2.9 cm)
- AWM171** Round  
17 1/4" Dia. x 1 1/8" H  
(43.8 x 2.9 cm)
- AWM21** Round  
21 1/2" Dia. x 1 1/8" H  
(54.6 x 2.9 cm)

### Acacia Melamine Serving Peels BPA FREE

- AWM12** Rectangular  
12" L x 6" W x 1/2" H  
17 1/2" L with Handle  
(30.5 x 15.2 x 1.3, 44.5 cm)
- AWM10** Square  
10" L x 9" W x 1/2" H  
14 1/2" L with Handle  
(25.4 x 22.9 x 1.3, 36.8 cm)

NEW



### Acacia Melamine

#### Serving Bowls

NEW BPA FREE

With the look of acacia wood matched with the durability of melamine, these generous-sized serving bowls are made to be true crowd-pleasers. From salads to sides, these bowls provide an elegant backdrop to any group dining event.

- AWMB11** 97 oz. (2.9 L)  
11" Dia. x 3 1/8" H  
(27.9 x 7.9 cm)
- AWMB12** 137 oz. (4.1 L)  
12 3/4" Dia. x 3 3/8" H  
(32.4 x 8.6 cm)
- AWMB14** 235 oz. (6.9 L)  
14 3/4" Dia. x 3 1/2" H  
(37.5 x 8.9 cm)

### Wood Melamine Serving Boards

BPA FREE

- MPLB** Bamboo  
20 7/8" L x 12 1/2" W x 3/8" H  
(53 x 31.8 x 1 cm)
- MPLW** Walnut  
20 7/8" L x 12 1/2" W x 3/8" H  
(53 x 31.8 x 1 cm)
- MPLA** Elm  
20 7/8" L x 12 1/2" W x 3/8" H  
(53 x 31.8 x 1 cm)

MPLB



MPLW



MPLA







WMEL21

WMEL23

WMEL19

### Rectangular Walnut Melamine Platters BPA FREE

**WMEL19** 14 ¼" L x 7 ½" W x 1 ½" H  
(36.2 x 19.1 x 3.8 cm)

**WMEL23** 18" L x 8 7⁄8" W x 2" H  
(45.7 x 22.5 x 5.1 cm)

**WMEL21** 21 ¾" L x 13" W x 1 ¾" H  
(54.3 x 33 x 4.4 cm)

### Black and White Melamine Serving Trays BPA FREE

You can't go wrong with a timeless black and white color scheme. Perfect for food halls, marketplaces and quick serve restaurants, these lightweight, dishwasher-safe trays are the perfect carrying case for your meal.

**MTB20** Black  
19 ¾" L x 12 ½" W x 1" H  
(49.2 x 31.8 x 2.5 cm)

**MTW20** White  
19 ¾" L x 12 ½" W x 1" H  
(49.2 x 31.8 x 2.5 cm)



Shown with NSB10 number stand,  
MSCSW3 sauce cup and MCB36WH bowl

MTB20

MTW20



### Tapered Birch Bread Baskets

Available in our most popular sizes, these real wooden pieces perform double duty as baskets or risers.

- TWBB53** 5" Sq. x 3" H  
(12.7 x 7.6 cm)
- TWBB73** 7" Sq. x 3 1/4" H  
(17.8 x 8.3 cm)
- TWBB94** 9 1/2" Sq. x 4" H  
(24.1 x 10.2 cm)
- TWBB124** 12" Sq. x 4 1/2" H  
(30.5 x 11.4 cm)
- TWBBREC** 9 1/4" L x 6 1/4" W x 3" H  
(23.5 x 15.9 x 7.6 cm)







HOT

BWB109

BWB105

Shown with BHCHD1, BHCHL1 card holders and TAGA7WT mini chalk cards

CRAB CAKES  
with  
REMOULADE

LOBSTER  
BLTs

BWB189

TWO-SIDED FOR  
VERSATILE REVERSABILITY

BWB185



BWF4

Shown with  
GMB8 glass  
milk bottles

### THE BAMBOO COLLECTION

Go green without sacrificing looks with environmentally friendly bamboo. Warm wood-like tones make this collection a casual way to elevate breakfast buffets, catering, room service and more.

#### Carbonized Bamboo Serving Boards HOT 🔥

**BWB105** 10" L x 5 3/4" W x 3/4" H  
(25.4 x 14.6 x 1.9 cm)

**BWB109** 10" L x 9" W x 3/4" H  
(25.4 x 22.9 x 1.9 cm)

**BWB185** 18 1/4" L x 5 3/4" W x 3/4" H  
(46.4 x 14.6 x 1.9 cm)

**BWB189** 18 1/4" L x 9" W x 3/4" H  
(46.4 x 22.9 x 1.9 cm)

#### Carbonized Bamboo Flight Boards 🔥

**BWF4** Flight Board  
13 7/8" L x 3 3/8" W x 1 1/4" H  
(35.2 x 8.6 x 3.2 cm)

**BWF3** Pairing Flight Board  
13 7/8" L x 6 7/8" W x 1 1/4" H  
(35.2 x 17.5 x 3.2 cm)



Shown with  
MP6 melamine  
paper plate and  
GMB8 glass milk  
bottles

BWF3





BWBO shown with MB4 sauce cup

Shown with GMB8 milk bottles

BWBR

## Carbonized Bamboo Serving Peels and Boards

### Serving Boards

- BWBR** Round  
9" Dia. x ¾" H  
(22.9 x 1.9 cm)
- BWBO** Oblong  
13 ½" L x 6" W x ¾" H  
(34.3 x 15.2 x 1.9 cm)

### Serving Peels

- BWBS** Rectangular  
9 ¼" L x 5" W x ¾" H  
13 ¼" L with Handle  
(23.5 x 12.7 x 1.9, 33.7 cm)
- BWBL** Rectangular  
15" L x 7" W x ¾" H  
19" L with Handle  
(38.1 x 17.8 x 1.9, 48.3 cm)



Shown with HMMJ5 apothecary jar

BWBL

ALL OF OUR CARBONIZED SERVING PIECES FEATURE A RICH WOOD PATINA THAT IS LIGHT BROWN ON ONE SIDE AND DARK BROWN ON THE OTHER

BWBS shown with CKNF2 cheese knife





**BAM18** shown with  
**PBSL2** liner and  
**FRYR375** fry basket

**BAM1812**

**BAM22**

**BAM14**

## Rectangular Bamboo Trays

- BAM14** 14 1/4" L x 7 1/2" W x 1 1/2" H  
(36.2 x 19.1 x 3.8 cm)
- BAM18** 18 1/8" L x 9 1/8" W x 2" H  
(46 x 23.2 x 5.1 cm)
- BAM1812** 18" L x 12" W x 2" H  
(45.7 x 30.5 x 5.1 cm)
- BAM22** 21 3/4" L x 13 1/8" W x 2" H  
(55.2 x 33.3 x 5.1 cm)

### Disposable Liners

- PBSL1** 13 3/4" L x 7 1/4" W x 1" H  
(34.9 x 18.4 x 2.5 cm)  
PET Liner for BAM14
- PBSL2** 17 1/2" L x 8 3/4" W x 2" H  
(44.5 x 22.2 x 5.1 cm)  
PET Liner for BAM18
- PBSL3** 19 1/2" L x 12" W x 2" H  
(49.5 x 30.5 x 5.1 cm)  
PET Liner for BAM22

## Flat Bamboo Platters

- BAM148** 14 1/2" L x 8 1/4" W x 7/8" H  
(36.8 x 21 x 2.2 cm)
- BAM189** 18 1/4" L x 9" W x 7/8" H  
(46.4 x 22.9 x 2.2 cm)
- BAM141** 14 3/8" Sq. x 7/8" H  
(36.5 x 2.2 cm)
- BAM211** 21 1/2" L x 13" W x 7/8" H  
(54.6 x 33 x 2.2 cm)



**BAM211**

**BAM148**

**BAM189**

**BAM141**

### Round Bamboo Butcher Blocks

- B10** 10" Dia. x 1 1/2" H  
(25.4 x 3.8 cm)
- B12** 12" Dia. x 1 1/2" H  
(30.5 x 3.8 cm)
- B14** 14" Dia. x 1 1/2" H  
(35.6 x 3.8 cm)
- B16** 16" Dia. x 1 1/2" H  
(40.6 x 3.8 cm)



### Square Bamboo Bowls

- BAM53** 23 oz. (680.2 mL)  
5" Sq. x 3" H  
(12.7 x 7.6 cm)
- BAM73** 58 oz. (1.7 L)  
7" Sq. x 3 1/4" H  
(17.8 x 8.3 cm)
- BAM94** 125 oz. (3.7 L)  
9 1/2" Sq. x 4" H  
(24.1 x 10.2 cm)
- BAM124** 202 oz. (6 L)  
12" Sq. x 4 1/2" H  
(30.5 x 11.4 cm)

### Angled Bamboo Bowls

- BAMSL52** 8 oz. (236.6 mL)  
5" Dia. x 3 1/2" H  
(12.7 x 8.9 cm)
- BAMSL82** 22 oz. (650.6 mL)  
8 1/4" Dia. x 5 3/8" H  
(21 x 13.7 cm)
- BAMSL92** 48 oz. (1.4 L)  
9 3/4" Dia. x 6 1/8" H  
(24.8 x 15.6 cm)
- BAMSL112** 80 oz. (2.4 L)  
11 1/2" Dia. x 7 1/4" H  
(29.2 x 18.4 cm)







AWB12

AWB10

AWB7 shown with  
HS2 oval hammered sauce cup  
and CKNF7 soft cheese spreader



AWB1210

AWB147

### THE ASH WOOD COLLECTION

These ash wood boards and peels feature rich patterns, earthy looks and unique handle designs. From charcuterie to single serving sandwiches, there's a size for every need. See pg. 458-459 for special care instructions.

#### Rimmed Oval Ash Wood Serving Boards

- AWB7 7" L x 4" W x ¾" H (17.8 x 10.2 x 1.9 cm)
- AWB10 9" L x 6" W x ¾" H (22.9 x 15.2 x 1.9 cm)
- AWB12 12" L x 9" W x ¾" H (30.5 x 22.9 x 1.9 cm)

#### Rimmed Ash Wood Serving Boards

- AWB147 14" L x 7" W x ¾" H (35.6 x 17.8 x 1.9 cm)
- AWB1210 12" L x 10" W x ¾" H (30.5 x 25.4 x 1.9 cm)

## Ash Wood Rectangular Serving Boards

**AWB1016** 16" L x 10" W x ¾" H  
(40.6 x 25.4 x 1.9 cm)

**AWB621** 21" L x 6" W x ¾" H  
(53.3 x 15.2 x 1.9 cm)

**AWB1021** 21" L x 10" W x ¾" H  
(53.3 x 25.4 x 1.9 cm)

## Ash Wood Serving Peels

**AWB617** 12" L x 6" W x ¾" H  
17" L with Handle  
(30.5 x 15.2 x 1.9, 43.2 cm)

**AWB179** 12" L x 9" W x ¾" H,  
17" L with Handle  
(30.5 x 22.9 x 1.9, 43.2 cm)







MWP13 shown with LFTD12

MWP12 shown with LFTD11

MWP5

MWPD6

LFTD8

MWP4 shown with LFTD3

MWP5 shown with LFTD4

MWP9



MWP13

MWP12

MWP4

MWP9

MWP5

## THE UPTON COLLECTION

In today's world where we eat with our eyes, visual display is key. Enter the Upton Collection: A mix of espresso-finished wood display items perfectly paired with crystal clear domes. The result is a head-turning, rich display sure to catch customer attention.

### Upton Collection Plates

Handcrafted, espresso-finished wood plates and platters are perfectly rimmed to frame any menu option. From baked goods to cheese plates, these wood boards will complement any food pairing.

**MWP4** 4 ¼" Dia. x ¾" H  
(10.8 x 1.9 cm)

**MWP5** 5" Dia. x ¾" H  
(12.7 x 1.9 cm)

**MWP9** 9" Dia. x ¾" H  
(22.9 x 1.9 cm)

**MWP12** 12" Dia. x ¾" H  
(30.5 x 1.9 cm)

**MWP13** 13" Dia. x ¾" H  
(33 x 1.9 cm)

**MWP14** 14 ¼" L x 6 ⅝" W x 1" H  
(36.2 x 16.8 x 2.5 cm)



Shown with GVHT6 tongs

NEW

MWP14 shown with LFTD135

NEW

**Upton Collection Platters** NEW

Give your charcuterie spreads and grazing tables an elegant boost with these stately espresso platters from the Upton Collection. They pair perfectly with our Black Twilight Modular Risers for a knockout presentation.

- MWP18** 17 ¾" L x 8 ¾" W x 7/8" H  
(45.1 x 22.2 x 2.2 cm)
- MWP24** 24" L x 8 ¾" W x 7/8" H  
(61 x 22.2 x 2.2 cm)
- MWP32** 32" L x 8 ¾" W x 7/8" H  
(81.3 x 22.2 x 2.2 cm)

**Upton Collection Pedestals**

Elegant and beautiful, our Upton Collection pedestals can really be considered works of art. Handcrafted to provide height and beauty to any display. Use with an Upton Collection plate or a clear dome to finish the look.

- MWPD5** 7" Top Dia. x 5 ¼" H  
(17.8 x 13.3 cm)
- MWPD6** 9" Top Dia. x 6 ¼" H  
(22.9 x 15.9 cm)

**Clear Domes** !

- LFTD3** 3 ⅝" Dia. x 3 ½" H  
(8.6 x 8.9 cm)
- LFTD4** 4 ⅛" Dia. x 3 ⅞" H  
(10.5 x 9.8 cm)
- LFTD8** 8 ⅛" Dia. x 6 ⅝" H  
(20.6 x 16.8 cm)
- LFTD11** 11" Dia. x 8 ⅝" H  
(27.9 x 21.9 cm)
- LFTD12** 12 ⅛" Dia. x 9 ⅞" H  
(30.8 x 23.2 cm)
- LFTD135** 13 ½" L x 5 ⅞" W x 8" H  
(34.3 x 14.9 x 20.3 cm)

NEW



**WARNING:** This product can expose you to chemicals including Bisphenol A (BPA), which is known to the State of California to cause birth defects or other reproductive harm. For more information, go to [www.P65warnings.ca.gov](http://www.P65warnings.ca.gov). Warning applies to State of California only.





## THE OLIVE WOOD COLLECTION

Whether you choose our striking geometric style or our wavy organic style, you'll have a board with gorgeous marbling and memorable design. No two boards are exactly alike.

### Short-Handle Olive Wood Serving Peels

- OWP9** 8" W x 9" L Blade  
14" with Handle  
(20.3 x 22.9, 35.6 cm)
- OWP13** 12" W x 13" L Blade  
22" with Handle  
(30.5 x 33, 55.9 cm)
- OWP15** 14" W x 15" L Blade  
24" with Handle  
(35.6 x 38.1, 61 cm)
- OWP17** 16" W x 17" L Blade  
26" with Handle  
(40.6 x 43.2, 66 cm)

### Olive Wood Serving Peels

- OWB116** 9 1/4" L x 6" W x 5/8" H  
10 3/4" L with Handle  
(23.5 x 15.2 x 1.6, 27.3 cm)
- OWB117** 9 3/8" L x 5 3/4" W x 5/8" H  
12 1/8" L with Handle  
(23.8 x 14.6 x 1.6, 30.8 cm)
- OWB118** 13 7/8" L x 5 7/8" W x 5/8" H  
16 1/8" L with Handle  
(35.2 x 14.9 x 1.6, 41 cm)
- OWB149** 9 7/8" L x 9 1/8" W x 5/8" H  
14" L with Handle  
(25.1 x 23.2 x 1.6, 35.6 cm)

### Organic Olive Wood Serving Peels

- OWP157** 10 3/4" L x 7" W x 3/4" H  
14 3/4" L with Handle  
(27.3 x 17.8 x 1.9, 37.5 cm)
- OWP178** 12 1/8" L x 7 3/4" W x 3/4" H  
17 3/8" L with Handle  
(30.8 x 19.7 x 1.9, 44.1 cm)





### Olive Wood Polyresin Serving Boards

A showstopping way to serve hors d'oeuvres and charcuteries. These high-end, food-safe serving boards infuse stunning olive wood with a streak of vibrant blue polyresin.

- OWP14** 14" L x 7" W x  $\frac{5}{8}$ " H  
(35.6 x 17.8 x 1.6 cm)
- OWP12** 12" L x 10" W x  $\frac{5}{8}$ " H  
(30.5 x 25.4 x 1.6 cm)
- OWP18** 18" L x 10" W x  $\frac{5}{8}$ " H  
(45.7 x 25.4 x 1.6 cm)

### Large Olive Wood Serving Boards

- OWB1810** 18" L x 9  $\frac{1}{8}$ " W x  $\frac{3}{4}$ " H  
(45.7 x 23.2 x 1.9 cm)
- OWB208** 20" L x 8" W x  $\frac{3}{4}$ " H  
(50.8 x 20.3 x 1.9 cm)
- OWB2213** 22" L x 13" W x  $\frac{3}{4}$ " H  
(55.9 x 33 x 1.9 cm)







## Olive Wood Serving Boards

**OWB107** 10" L x 7" W x ¾" H  
(25.4 x 17.8 x 1.9 cm)

**OWB129** 12" L x 9" W x ¾" H  
(30.5 x 22.9 x 1.9 cm)

## Oblong Olive Wood Boats

**OWSP** 12" L x 4 ½" W x 1" H  
(30.5 x 11.4 x 2.5 cm)

**OWMP** 17 ¾" L x 5 ¼" W x 1 ¼" H  
(45.1 x 13.3 x 3.2 cm)

**OWLP** 23 ⅝" L x 5 ⅞" W x 1 ¼" H  
(60 x 14.9 x 3.2 cm)







**Oval Olive Wood Serving Boards** 

**OWPB9** 9 7/8" L x 5 7/8" W x 1/2" H  
(25.1 x 14.9 x 1.3 cm)

**OWPB16** 16 1/8" L x 7 1/8" W x 1/2" H  
(41 x 18.1 x 1.3 cm)

**Olive Wood Bread Crates** 

**OWBB1** 8 1/2" L x 4" W x 2 3/8" H  
(21.6 x 10.2 x 6 cm)

**OWBB2** 8" L x 6" W x 2 3/8" H  
(20.3 x 15.2 x 6 cm)



FLIP CRATES OVER TO  
USE THEM AS RISERS





## Olive Wood/Marble Serving Peels

### Gray Marble

**OWBG8** 6" L x 3 1/2" W x 1/2" H  
8" L with Handle  
(15.2 x 8.9 x 1.3, 20.3 cm)

**OWBG9** 5 5/8" L x 5 1/4" W x 1/2" H  
9" L with Handle  
(14.3 x 13.3 x 1.3, 22.9 cm)

**OWBG15** 10" L x 9" W x 1/2" H  
14 3/4" L with Handle  
(25.4 x 22.9 x 1.3, 37.5 cm)

### Black Marble

**OWBB8** 6" L x 3 1/2" W x 1/2" H  
8" L with Handle  
(15.2 x 8.9 x 1.3, 20.3 cm)

**OWBB9** 5 5/8" L x 5 1/4" W x 1/2" H  
9" L with Handle  
(14.3 x 13.3 x 1.3, 22.9 cm)

**OWBB15** 10" L x 9" W x 1/2" H  
14 3/4" L with Handle  
(25.4 x 22.9 x 1.3, 37.5 cm)

Shown with CHGS card holder  
and TAGA7WT mini chalk card







### Loft Collection Acacia Wood Serving Boards

Plate up anything from pizzas to charcuterie in these beautifully grained wood boards. Made of durable acacia wood, each board is double-sided for versatility in serving. Pair with risers and accessories from the Loft Collection for a complete look.

- ATP10** 10" Dia. x  $\frac{5}{8}$ " H  
(25.4 x 1.6 cm)
- ATP12** 12" Dia. x  $\frac{5}{8}$ " H  
(30.5 x 1.6 cm)
- ATP14** 14" Dia. x  $\frac{5}{8}$ " H  
(35.6 x 1.6 cm)
- ATP16** 16" Dia. x  $\frac{5}{8}$ " H  
(40.6 x 1.6 cm)

### Acacia Wood Serving Platters

Acacia wood adds a touch of rustic beauty to any buffet line or grazing table. These organically-edged platters will easily boost the look of any charcuterie board or display. They pair perfectly with our Black Twilight Modular Risers for a knockout presentation.

- AB189** 17  $\frac{3}{4}$ " L x 8  $\frac{3}{4}$ " W x  $\frac{3}{4}$ " H  
(45.1 x 22.2 x 1.9 cm)
- AB249** 24" L x 8  $\frac{3}{4}$ " W x  $\frac{3}{4}$ " H  
(61 x 22.2 x 1.9 cm)
- AB329** 32" L x 8  $\frac{3}{4}$ " W x  $\frac{3}{4}$ " H  
(81.3 x 22.2 x 1.9 cm)







MBM4 shown with GJ6 jar

## Maple Pressed Wood Serving Peels <sup>USA</sup>

A beautiful maple veneer gives these peels the look and feel of wood, but they're also dishwasher-safe. Use them anywhere you'd use a traditional plate.

### Rectangular

**MBM2** 12 1/2" L x 4 3/8" W x 1/4" H  
18" L with Handle  
(31.8 x 11.1 x 0.6, 45.7 cm)

**MBM3** 12 1/2" L x 6 1/2" W x 1/4" H  
18" L with Handle  
(31.8 x 16.5 x 0.6, 45.7 cm)

**MBM4** 13" L x 8 1/8" W x 1/4" H  
18" L with Handle  
(33 x 20.6 x 0.6, 45.7 cm)

### Round

**MBM180** 18" Dia. x 1/4" H  
28 1/2" L with Handle  
(45.7 x 0.6, 72.4 cm)



MBM4

MBM3

MBM2



USA

MBM180

REPLACE TRADITIONAL PLATES  
WITH CREATIVE SERVING PEELS

**Maple Pressed Wood****Serving Boards** USA

A beautiful maple veneer gives these boards the look and feel of wood, but they're also dishwasher-safe. Perfect for flatbreads

- MBSB11** 11" L x 7" W x ¼" H  
(27.9 x 17.8 x 0.6 cm)
- MBSB17** 17" L x 9" W x ¼" H  
(43.2 x 22.9 x 0.6 cm)
- MBSB20** 19" L x 9" W x ¼" H  
(48.3 x 22.9 x 0.6 cm)

**Black Pressed Wood****Serving Boards**

Made of natural wood fiber material, this black serving board is the perfect companion to our Mega Flatbread Screens.

- MPSB16** 16" L x 8" W x ¼" H  
(40.6 x 20.3 x 0.6 cm)

**Rectangular Wood****Serving Peels** USA

- MSB2** 12 ½" L x 4 ¾" W x ⅝" H  
18" L with Handle  
(31.8 x 11.1 x 1.6, 45.7 cm)
- MSB3** 12 ½" L x 6 ½" W x ⅝" H  
18" L with Handle  
(31.8 x 16.5 x 1.6, 45.7 cm)
- MSB4** 13" L x 8 ⅝" W x ⅝" H  
18" L with Handle  
(33 x 20.6 x 1.6, 45.7 cm)

**Heavy Rubber Wood****Bread Boards** USA

- BB812** 9" L x 8 ⅝" W x ¾" H  
12 ½" L with Handle  
(22.9 x 20.6 x 1.9, 31.8 cm)
- BB816** 10 ⅞" L x 8 ⅝" W x ¾" H  
16 ¼" L with Handle  
(25.7 x 20.6 x 1.9, 41.3 cm)



BB816

BB812



MBSB17

USA

MBSB20

MBSB11



MPSB16



MSB2

MSB3

MSB4

STYLISH ENOUGH FOR FRONT-OF-HOUSE,  
DURABLE ENOUGH FOR BACK-OF-HOUSE





**HOT**

SB7

SB5

SB3



SB575

SB450

SB400

SB325

**Squound Stainless Steel Bowls** **HOT**

Pair stainless steel with a mix of round and square shapes, and you get some of the most contemporary serving bowls on the market.

- SB3** 40 oz. (1.2 L)  
7" Dia. x 2 1/8" H (17.8 x 5.4 cm)
- SB5** 67 oz. (2 L)  
9" Dia. x 2 3/4" H (22.9 x 7 cm)
- SB7** 126 oz. (3.7 L)  
11" Dia. x 3" H (27.9 x 7.6 cm)

**Squound Stainless Steel Snack Bowls**

- SB325** 3 oz. (88.7 mL)  
3 1/8" Dia. x 1 1/2" H (7.9 x 3.8 cm)
- SB400** 5 1/2 oz. (162.7 mL)  
3 3/4" Dia. x 1 5/8" H (9.5 x 4.1 cm)
- SB450** 9 1/2 oz. (280.9 mL)  
4 1/2" Dia. x 2" H (11.4 x 5.1 cm)
- SB575** 15 oz. (443.6 mL)  
5 3/4" Dia. x 2 1/2" H (14.6 x 6.4 cm)



SB1

**Round Checker Bowl**

With tasteful square cutouts, this brushed stainless steel bowl is a great way to add instant intrigue to baked goods.

- SB1** Checker  
8" Dia. x 3 5/8" H (20.3 x 9.2 cm)



### Squound Hammered Bowls

<b>SBH3</b>	40 oz. (1.2 L) 7" Dia. x 2 1/8" H (17.8 x 5.4 cm)
<b>SBH5</b>	67 oz. (2 L) 9" Dia. x 2 3/4" H (22.9 x 7 cm)
<b>SBH7</b>	126 oz. (3.7 L) 11" Dia. x 3" H (27.9 x 7.6 cm)

### Squound Hammered Snack Bowls

<b>SBH325</b>	3 oz. (88.7 mL) 3 1/8" Dia. x 1 1/2" H (7.9 x 3.8 cm)
<b>SBH400</b>	5 1/2 oz. (162.7 mL) 3 3/4" Dia. x 1 5/8" H (9.5 x 4.1 cm)
<b>SBH450</b>	9 1/2 oz. (280.9 mL) 4 1/2" Dia. x 2" H (11.4 x 5.1 cm)
<b>SBH575</b>	15 oz. (443.6 mL) 5 3/4" Dia. x 2 1/2" H (14.6 x 6.4 cm)



Shown with MSTNG5 tongs

### Moroccan Hammered Bowls

These one-of-a-kind stainless steel bowls are great serving vessels for global cuisine and practically anything else.

<b>HB5</b>	16 oz. (473.2 mL) 5" Dia. x 2" H (12.7 x 5.1 cm)
<b>HB6</b>	27 oz. (798.5 mL) 6" Dia. x 2 1/2" H (15.2 x 6.4 cm)
<b>HB7</b>	38 oz. (1.1 L) 6 3/4" Dia. x 2 3/4" H (17.1 x 7 cm)



Shown with SPM4 S&P shakers



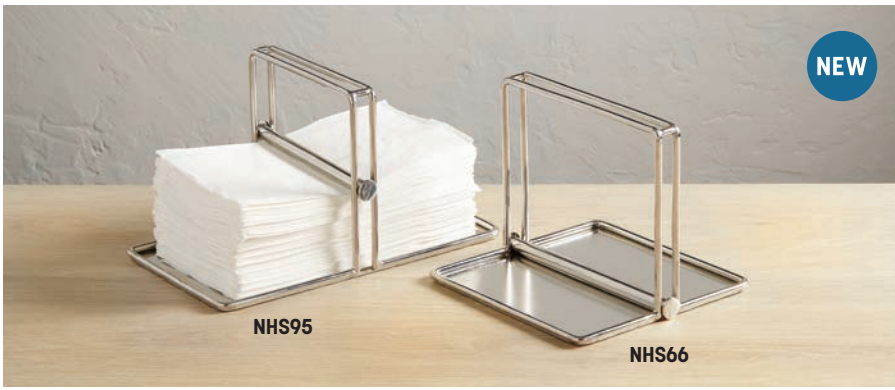

### Stainless Steel Napkin Holders NEW

Modern and sleek, these napkin holders offer a functional design that keeps both full and bar-sized napkins neatly in place, even for outdoor events.

- NHS66**    6" Sq. x 5" H  
(15.2 x 12.7 cm)
- NHS95**    9" L x 5" W x 5" H  
(22.9 x 12.7 x 12.7 cm)

### Satin Finish Stainless Steel Trays with Sides

- ST10**    10" L x 4 1/2" W x 1/2" H  
(25.4 x 11.4 x 1.3 cm)
- ST12**    12" L x 8 1/4" W x 1/2" H  
(30.5 x 21 x 1.3 cm)
- ST20**    20 1/8" L x 4 1/2" W x 1/2" H  
(51.1 x 11.4 x 1.3 cm)



### Royal Touch™ Round Serving Trays

The name says it all. These heavy-duty stainless steel trays elevate catered events to glamorous affairs with their elegantly embossed design.

- SST10**    10" Dia. x 1/2" H  
(25.4 x 1.3 cm)
- SST12**    12" Dia. x 1/2" H  
(30.5 x 1.3 cm)
- SST14**    14" Dia. x 1/2" H  
(35.6 x 1.3 cm)



## THE HAMMERED COLLECTION

Snowflakes, fingerprints and pieces from our Hammered Collection. The connection? Each is one-of-a-kind. These stainless steel trays and bowls are individually hammered with a ball-peen hammer so that each is uniquely stunning.

### Hammered Stainless Steel Trays with Sides

**HMST10** 10" L x 4 1/2" W x 1/2" H  
(25.4 x 11.4 x 1.3 cm)

**HMST12** 12" L x 8 1/4" W x 1/2" H  
(30.5 x 21 x 1.3 cm)

**HMST20** 20 1/8" L x 4 1/2" W x 1/2" H  
(51.1 x 11.4 x 1.3 cm)

### Hammered Stainless Steel Sheet Pans

Prep, store and serve, all with one super-versatile pan. From the kitchen to the dining room, this jack-of-all-trades gets the job done.

**HMSP1813** Half-Size  
18" L x 13" W x 1" H  
(45.7 x 33 x 2.5 cm)

**HMSP2618** Full-Size  
26" L x 18" W x 1" H  
(66 x 45.7 x 2.5 cm)



IN YOUR CHOICE OF FULL AND  
HALF SIZES THAT STORE EASILY  
IN YOUR EVERYDAY SPEED RACK





HMRD16

HMRD08

HMRD12



HMOST1520

HMOST1317

HMOST1115

**Round Hammered Bowls**

- HMRD08** 34 oz. (1 L)  
8 1/2" Dia. x 1 5/8" H  
(21.6 x 4.1 cm)
- HMRD12** 85 oz. (2.5 L)  
12 1/8" Dia. x 2 1/4" H  
(30.8 x 5.7 cm)
- HMRD16** 168 oz. (5 L)  
16 1/4" Dia. x 2 3/4" H  
(41.3 x 7 cm)

**Oval Hammered Trays**

- HMOST1115** 15" L x 11" W x 3/4" H  
(38.1 x 27.9 x 1.9 cm)
- HMOST1317** 17 1/4" L x 13 1/4" W x 1 1/8" H  
(43.8 x 33.7 x 2.9 cm)
- HMOST1520** 20" L x 15 1/2" W x 1 1/8" H  
(50.8 x 39.4 x 2.9 cm)

**Oval Hammered Bowls**

- HMOV1418** 144 oz. (4.3 L)  
18 5/8" L x 14 1/4" W x 2 1/2" H  
(47.3 x 36.2 x 6.4 cm)
- HMOV1621** 192 oz. (5.7 L)  
20 1/8" L x 16 1/4" W x 3 1/2" H  
(51.1 x 41.3 x 8.9 cm)



HMOV1621

HMOV1418





### Square Hammered Trays

HMSQ12	12" Sq. x 1" H (30.5 x 2.5 cm)
HMSQ14	14" Sq. x 1" H (35.6 x 2.5 cm)
HMSQ16	16" Sq. x 1 1/8" H (40.6 x 2.9 cm)
HMSQ18	18" Sq. x 1 1/8" H (45.7 x 2.9 cm)
HMSQ20	20" Sq. x 1 1/8" H (50.8 x 2.9 cm)
HMSQ22	22" Sq. x 1 1/8" H (55.9 x 2.9 cm)

### Rectangular Hammered Trays

HMRT712	11 3/8" L x 7 3/8" W x 1" H (28.9 x 18.7 x 2.5 cm)
HMRT814	14 1/8" L x 7 5/8" W x 1" H (35.9 x 19.4 x 2.5 cm)
HMRT1019	18 5/8" L x 9 5/8" W x 1 3/8" H (47.3 x 24.4 x 3.5 cm)
HMRT1322	21 3/4" L x 12 3/4" W x 1 5/8" H (55.2 x 32.4 x 4.1 cm)





Shown with TAGA6WT chalk cards, LK50 card holders, GMB8 glass milk bottles



From top to bottom:  
HMRST1801  
HMRST2001  
HMRST2201

HMRST1401

HMRST1601



HMRST1301  
shown  
on SSUS1  
riser

HMRT1611

HMRT247

### Round Hammered Trays

- HMRST1401** 14" Dia. x 1 1/8" H  
(35.6 x 2.9 cm)
- HMRST1601** 16" Dia. x 1 1/8" H  
(40.6 x 2.9 cm)
- HMRST1801** 18" Dia. x 1 1/8" H  
(45.7 x 2.9 cm)
- HMRST2001** 20" Dia. x 1 1/8" H  
(50.8 x 2.9 cm)
- HMRST2201** 22" Dia. x 1 1/8" H  
(55.9 x 2.9 cm)

### Rectangular and Round Hammered Trays

- HMRT1611** Rectangular  
16 5/8" L x 11 1/4" W x 3/8" H  
(42.2 x 28.6 x 1 cm)
- HMRST1301** Round  
78 oz. (2.3 L), 13 3/8" Dia. x 1 3/8" H  
(34 x 3.5 cm)
- HMRT247** Rectangular  
23 1/2" L x 7 1/2" W x 1/2" H  
(59.7 x 19.1 x 1.3 cm)

USE THESE TO STAGE CLASSIC ENTRÉES OR AVANT-GARDE HORS D'OEUVRES; THESE PIECES FROM OUR HAMMERED COLLECTION RAISE CULINARY CREATIONS TO A HIGHER STANDARD OF ARTISTRY



## Hammered Stainless Steel Serving Pans

- THRD17** Round  
200 oz. (5.9 L)  
15" Dia. x 2 3/8" H  
17 5/8" Dia. x 3 7/8" H with Handles  
(38.1 x 6, 44.8 x 9.8 cm)
- THOV19** Oval  
168 oz. (5 L)  
18 1/2" L x 12 3/4" W x 2" H  
20 1/2" L x 3 1/2" H with Handles  
(47 x 32.4 x 5.1, 52.1 x 8.9 cm)
- THRC21** Rectangular  
168 oz. (5 L)  
18 1/4" L x 14" W x 2" H  
20 1/8" L x 3 1/4" H with Handles  
(46.4 x 35.6 x 5.1, 51.1 x 8.3 cm)



## Stainless Steel Square Bowls

### Hammered

- SSQH53** 30 oz. (887.2 mL)  
5" Sq. x 2 3/4" H (12.7 x 7 cm)
- SSQH73** 70 oz. (2.1 L)  
7" Sq. x 3 1/4" H (17.8 x 8.3 cm)
- SSQH94** 146 oz. (4.3 L)  
9 1/2" Sq. x 3 3/4" H (24.1 x 9.5 cm)
- SSQH117** 254 oz. (7.5 L)  
12" Sq. x 4 1/2" H (30.5 x 11.4 cm)

### Satin Finish

- SSQ53** 30 oz. (887.2 mL)  
5" Sq. x 2 3/4" H (12.7 x 7 cm)
- SSQ73** 70 oz. (2.1 L)  
7" Sq. x 3 1/4" H (17.8 x 8.3 cm)
- SSQ94** 146 oz. (4.3 L)  
9 1/2" Sq. x 3 3/4" H (24.1 x 9.5 cm)
- SSQ117** 254 oz. (7.5 L)  
12" Sq. x 4 1/2" H (30.5 x 11.4 cm)







## DOUBLE-WALL BOWLS

Need to keep sauces, desserts and entrées cold? These stainless steel bowls get the job done and look fantastic in the process.

### Hammered Double-Wall Bowls

- DWBH4** 17 oz. (502.8 mL)  
4 ¾" Dia. x 2 ½" H (12.1 x 6.4 cm)
- DWBH6** 34 oz. (1 L)  
6" Dia. x 3" H (15.2 x 7.6 cm)
- DWBH10** 156 oz. (4.6 L)  
10" Dia. x 4" H (25.4 x 10.2 cm)
- DWBH12** 220 oz. (6.5 L)  
12" Dia. x 5" H (30.5 x 12.7 cm)
- DWBH14** 338 oz. (10 L)  
14" Dia. x 5" H (35.6 x 12.7 cm)
- DWBH16** 512 oz. (15.1 L)  
16" Dia. x 5 ¾" H (40.6 x 14.6 cm)
- HMDWB14** 250 oz. (7.4 L)  
14 ⅜" Dia. x 3 ¾" H (36.5 x 9.5 cm)
- HMDWB19** 657 oz. (19.4 L)  
19" Dia. x 5 ½" H (48.3 x 14 cm)

### Stackable Double-Wall Bowls

- SDWB40** 8 oz. (236.6 mL)  
4" Dia. x 2" H (10.2 x 5.1 cm)
- SDWB45** 10 oz. (295.7 mL)  
4 ½" Dia. x 2" H (11.4 x 5.1 cm)
- SDWB55** 16 oz. (473.2 mL)  
5 ½" Dia. x 2" H (14 x 5.1 cm)



**Satin Finish Double-Wall Bowls**

- SW4** 17 oz. (502.8 mL)  
4 3/4" Dia. x 2 1/2" H (12.1 x 6.4 cm)
- DWB6** 34 oz. (1 L)  
6" Dia. x 3" H (15.2 x 7.6 cm)
- DWB10** 156 oz. (4.6 L)  
10" Dia. x 4" H (25.4 x 10.2 cm)
- DWB12** 220 oz. (6.5 L)  
12" Dia. x 5" H (30.5 x 12.7 cm)
- DWB14** 338 oz. (10 L)  
14" Dia. x 5" H (35.6 x 12.7 cm)
- DWB16** 512 oz. (15.1 L)  
16" Dia. x 5 3/4" H (40.6 x 14.6 cm)

**Angled Double-Wall Bowls**

- AB6** 23 oz. (680.2 mL)  
6" Dia. x 3 1/2" H (15.2 x 8.9 cm)
- AB8** 54 oz. (1.6 L)  
8" Dia. x 4 5/8" H (20.3 x 11.7 cm)
- AB12** 108 oz. (3.2 L)  
10" Dia. x 5" H (25.4 x 12.7 cm)
- AB13** 216 oz. (6.4 L)  
12" Dia. x 6" H (30.5 x 15.2 cm)
- AB14** 304 oz. (9 L)  
13 7/8" Dia. x 6 1/2" H (35.2 x 16.5 cm)



UNIQUELY GEOMETRIC  
BOTTOM STYLING



Good



### Aluminum Seafood Trays

- SEA10** 36 oz., 10" Dia. x 2 1/4" H  
(1.1 L, 25.4 x 5.7 cm)
- SEA12** 75 oz., 12" Dia. x 2 1/4" H  
(2.2 L, 30.5 x 5.7 cm)
- SEA14** 120 oz., 13 7/8" Dia. x 2 1/4" H  
(3.5 L, 35.2 x 5.7 cm)
- SEA16** 160 oz., 16" Dia. x 2 1/4" H  
(4.7 L, 40.6 x 5.7 cm)
- SEA18** 200 oz., 17 3/4" Dia. x 2 1/4" H  
(5.9 L, 45.1 x 5.7 cm)
- SEA20** 250 oz., 19 3/4" Dia. x 2 1/4" H  
(7.4 L, 50.2 x 5.7 cm)

Better



### Stainless Steel Seafood Trays

- SSEA10** 36 oz., 10" Dia. x 2 1/4" H  
(1.1 L, 25.4 x 5.7 cm)
- SSEA12** 118 oz., 12 1/2" Dia. x 2 1/4" H  
(3.5 L, 31.8 x 5.7 cm)
- SSEA14** 169 oz., 14 5/8" Dia. x 2 1/4" H  
(5 L, 37.1 x 5.7 cm)
- SSEA16** 230 oz., 16 3/8" Dia. x 2 1/4" H  
(6.8 L, 41.6 x 5.7 cm)
- SSEA18** 287 oz., 17 3/4" Dia. x 2 1/4" H  
(8.5 L, 45.1 x 5.7 cm)

Best



### Double-Wall Stainless Steel Seafood Trays

- DWSEA10** 56 oz., 10" Dia. x 2 1/4" H  
(1.7 L, 25.4 x 5.7 cm)
- DWSEA12** 80 oz., 12" Dia. x 2 1/4" H  
(2.4 L, 30.5 x 5.7 cm)
- DWSEA14** 112 oz., 14" Dia. x 2 1/4" H  
(3.3 L, 35.6 x 5.7 cm)
- DWSEA16** 160 oz., 15 1/2" Dia. x 2 1/4" H  
(4.7 L, 39.4 x 5.7 cm)
- DWSEA18** 204 oz., 17 5/8" Dia. x 2 1/4" H  
(6 L, 44.8 x 5.7 cm)

Best



### Double-Wall Hammered Stainless Steel Seafood Trays

- DWHSEA10** 56 oz., 10" Dia. x 2 1/4" H  
(1.7 L, 25.4 x 5.7 cm)
- DWHSEA12** 80 oz., 12" Dia. x 2 1/4" H  
(2.4 L, 30.5 x 5.7 cm)
- DWHSEA14** 112 oz., 14" Dia. x 2 1/4" H  
(3.3 L, 35.6 x 5.7 cm)
- DWHSEA16** 160 oz., 15 1/2" Dia. x 2 1/4" H  
(4.7 L, 39.4 x 5.7 cm)
- DWHSEA18** 204 oz., 17 5/8" Dia. x 2 1/4" H  
(6 L, 44.8 x 5.7 cm)



**SSEA12 and SSEA16** trays shown with SDRCK



**DWHSEA12 and DWHSEA18** shown with SDRCK seafood display rack



## Single-Wall

## Double-Wall



## Copper Hammered Aluminum Seafood Trays

### Single-Wall

**ASEAC12** 80 oz., 12" Dia. x 2" H  
(2.4 L, 30.5 x 5.1 cm)

**ASEAC14** 128 oz., 14" Dia. x 2 1/2" H  
(3.8 L, 35.6 x 6.4 cm)

### Double-Wall

**ADSEAC12** 80 oz., 12" Dia. x 2 1/4" H  
(2.4 L, 30.5 x 5.7 cm)

**ADSEAC14** 128 oz., 14" Dia. x 2 1/2" H  
(3.8 L, 35.6 x 6.4 cm)



## Silver Hammered Aluminum Seafood Trays

### Single-Wall

**ASEAS12** 80 oz., 12" Dia. x 2" H  
(2.4 L, 30.5 x 5.1 cm)

**ASEAS14** 128 oz., 14" Dia. x 2 1/2" H  
(3.8 L, 35.6 x 6.4 cm)

### Double-Wall

**ADSEAS12** 80 oz., 12" Dia. x 2 1/4" H  
(2.4 L, 30.5 x 5.7 cm)

**ADSEAS14** 128 oz., 14" Dia. x 2 1/2" H  
(3.8 L, 35.6 x 6.4 cm)



## Black Hammered Aluminum Seafood Trays

### Single-Wall

**ASEAB12** 80 oz., 12" Dia. x 2" H  
(2.4 L, 30.5 x 5.1 cm)

**ASEAB14** 128 oz., 14" Dia. x 2 1/2" H  
(3.8 L, 35.6 x 6.4 cm)

### Double-Wall

**ADSEAB12** 80 oz., 12" Dia. x 2 1/4" H  
(2.4 L, 30.5 x 5.7 cm)

**ADSEAB14** 128 oz., 14" Dia. x 2 1/2" H  
(3.8 L, 35.6 x 6.4 cm)



## Gold Hammered Aluminum Seafood Trays

### Single-Wall

**ASEAG12** 80 oz., 12" Dia. x 2" H  
(2.4 L, 30.5 x 5.1 cm)

**ASEAG14** 128 oz., 14" Dia. x 2 1/2" H  
(3.8 L, 35.6 x 6.4 cm)

### Double-Wall

**ADSEAG12** 80 oz., 12" Dia. x 2 1/4" H  
(2.4 L, 30.5 x 5.7 cm)

**ADSEAG14** 128 oz., 14" Dia. x 2 1/2" H  
(3.8 L, 35.6 x 6.4 cm)



ADSEAC12

ADSEAC14

Shown with SDRCK seafood display rack and MB1 sauce cup



ASEAB12

RUBBER COATING PREVENTS TRAYS FROM SLIDING

ASEAB1

Shown with RSRB stand, ASPB sauce cup, WVAT1 tongs and DPN9WH plates



NEW

MSEA10G and  
MSEA12G shown  
with RSRW8



NEW

### Melamine Seafood Trays

NEW BPA FREE

Stylish seafood setups are a breeze with a perfect combination of durable melamine trays, non-slip rubberized stands and perforated ice screens. Available in multiple colors to coordinate with every tabletop.

#### Silver

**MSEA10S** 67 oz., 10" Dia. x 2 ¼" H  
(2 L, 25.4 x 5.7 cm)

**MSEA12S** 110 oz., 13" Dia. x 2 ¼" H  
(3.3 L, 33 x 5.7 cm)

NEW

#### Black

**MSEA10B** 67 oz., 10" Dia. x 2 ¼" H  
(2 L, 25.4 x 5.7 cm)

**MSEA12B** 110 oz., 13" Dia. x 2 ¼" H  
(3.3 L, 33 x 5.7 cm)

NEW

#### Gold

**MSEA10G** 67 oz., 10" Dia. x 2 ¼" H  
(2 L, 25.4 x 5.7 cm)

**MSEA12G** 110 oz., 13" Dia. x 2 ¼" H  
(3.3 L, 33 x 5.7 cm)

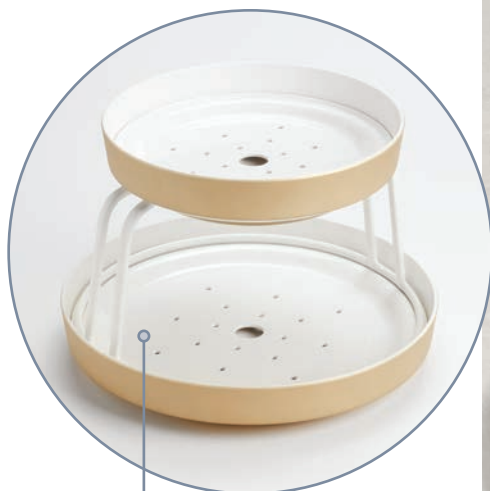

DURABLE MELAMINE DRIP TRAYS ADD AESTHETIC AND CONVENIENCE TO SEAFOOD PRESENTATION



### Melamine Seafood Drip Trays NEW BPA FREE

#### Black

**MDT9B** 9 3/8" Dia. x 5/8" H  
(23.8 x 1.6 cm)

**MDT12B** 12 3/8" Dia. x 5/8" H  
(31.4 x 1.6 cm)

#### White

**MDT9W** 9 3/8" Dia. x 5/8" H  
(23.8 x 1.6 cm)

**MDT12W** 12 3/8" Dia. x 5/8" H  
(31.4 x 1.6 cm)

### Rubberized Seafood Stands NEW WATER RESISTANT NON-SLIP

**RSRW8** White  
8 3/4" Top Dia. x 12" Bottom Dia. x 6 3/8" H  
(22.2 x 30.5 x 16.2 cm)

**RSRB8** Black  
8 3/4" Top Dia. x 12" Bottom Dia. x 6 3/8" H  
(22.2 x 30.5 x 16.2 cm)





NEW

DWHVSEA14 and DWHVSEA18 shown with SDRCKV7



NEW

### Oval Double-Wall Hammered Stainless Steel Seafood Trays NEW

Give everyone at the table a chance to dig into that delicious seafood display using our oval double-wall seafood trays. Made of hand-hammered stainless steel and double-walled for extra insulation, seafood towers have never looked so good. Longer, oblong shape allows for easy access on the table.

**DWHVSEA14** 81 oz., 14" L x 9" W x 2 1/4" H (2.4 L, 35.6 x 22.9 x 5.7 cm)

**DWHVSEA18** 139 oz., 18" L x 12" W x 2 1/4" H (4.1 L, 45.7 x 30.5 x 5.7 cm)

### Oblong Seafood Display Racks NEW

Now oblong trays and bowls get a lift with these dynamic oval display racks - the perfect way to ensure everyone at the table can grab a bite.

**SDRCKV4** 10" L x 5" W Top x 12" L x 7" W Bottom x 4" H (25.4 x 12.7 x 30.5 x 17.8 x 10.2 cm)

**SDRCKV7** 10" L x 5" W Top x 12" L x 7" W Bottom x 7 3/8" H (25.4 x 12.7 x 30.5 x 17.8 x 18.7 cm)

NEW



SDRCKV7



SDRCKV4



### Contempo™ Swirl Risers

The contemporary swirls of these risers are sure to elevate your cuisine in more ways than one. Wire is  $\frac{3}{8}$ " thick

**LWUS779** 7  $\frac{1}{8}$ " Top Dia. x 9" Bottom Dia. x 7" H  
(18.1 x 22.9 x 17.8 cm)

**LWUSR** 7" Top Dia. x 9" Bottom Dia. x 6  $\frac{3}{8}$ " H  
(17.8 x 22.9 x 16.2 cm)

**SSUS1** 7  $\frac{1}{4}$ " Top Dia. x 9" Bottom Dia. x 6  $\frac{3}{4}$ " H  
(18.4 x 22.9 x 17.1 cm)

### Seafood Display Racks HOT

**SDRCK4** Small  
7  $\frac{1}{2}$ " Top Dia. x 9  $\frac{5}{8}$ " Bottom Dia. x 4" H  
(19.1 x 24.4 x 10.2 cm)

**SDRCK** Large  
7  $\frac{1}{2}$ " Top Dia. x 9  $\frac{5}{8}$ " Bottom Dia. x 7  $\frac{3}{8}$ " H  
(19.1 x 24.4 x 18.7 cm)







RSRBH7

RSRBH4

RUBBERIZED COATING KEEPS  
BOWLS AND PANS IN PLACE



RSR10

RSRB4

RSRB

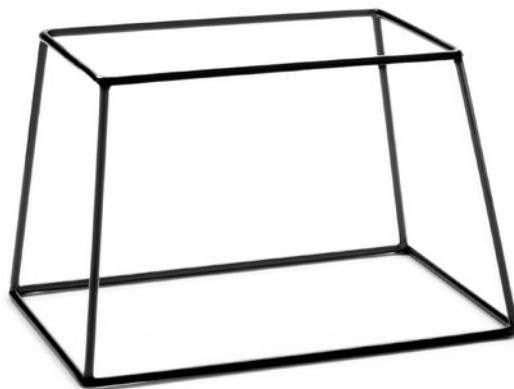

RSRB7

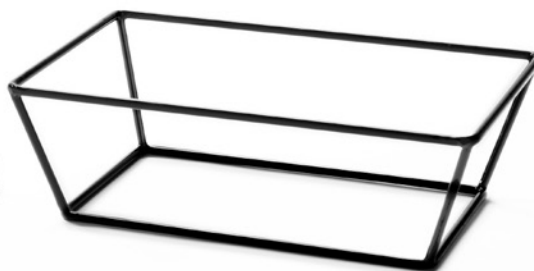

RSRB3

### Loft Collection Rubberized Hairpin Stands

The newest additions to our black rubberized stands, these risers boast unique hairpin curved legs with an added rubberized texture to keep things in place.

**RSRBH4** 9" Dia. x 4" H (22.9 x 10.2 cm)

**RSRBH7** 9" Dia. x 7" H (22.9 x 17.8 cm)

### Black Rubberized Stands

Tired of tracking down rubber stoppers to keep your pizza pans in place? These ingenious stands have the rubber built in. Plus, each of these contemporary wire-frame designs are reversible.

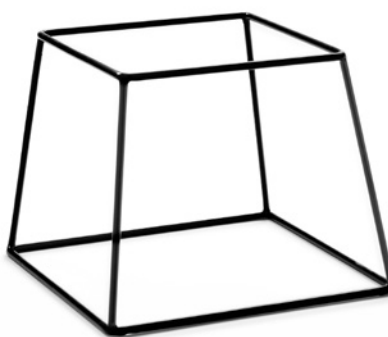

RSSB7

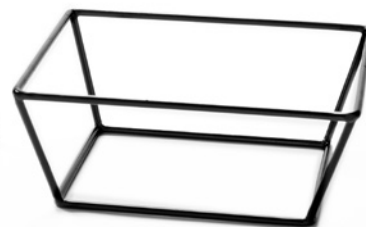

RSSB3

#### Round

**RSRB4** 7 1/2" Dia. Top x 9 5/8" Bottom Dia. x 4" H (19.1 x 24.4 x 10.2 cm)

**RSRB** 7 1/2" Dia. Top x 9 5/8" Bottom Dia. x 7 3/8" H (19.1 x 24.4 x 18.7 cm)

**RSR10** 8 3/8" Dia. Top x 9 7/8" Bottom Dia. x 11 3/4" H (21.3 x 25.1 x 29.8 cm)

#### Rectangular

**RSRB3** 9" L x 6" W Top x 11" L x 8" W Bottom x 3 1/2" H (22.9 x 15.2 x 27.9 x 20.3 x 8.9 cm)

**RSRB7** 9" L x 6" W Top x 11" L x 8" W Bottom x 7" H (22.9 x 15.2 x 27.9 x 20.3 x 17.8 cm)

#### Square

**RSSB3** 7" Sq. Top x 9" Sq. Bottom x 3 1/2" H (17.8 x 22.9 x 8.9 cm)

**RSSB7** 7" Sq. Top x 9" Sq. Bottom x 7" H (17.8 x 22.9 x 17.8 cm)

### Rubberized Wedges

Level up your display - literally - with these handy rubberized wedges! The rubberized coating allows you to prop up crates and trays for full display. Available in different heights for different needs.

**DWRB2** 5" L x 3" W x 2 1/2" H (12.7 x 7.6 x 6.4 cm)

**DWRB5** 5" L x 5" W x 5" H (12.7 x 12.7 x 12.7 cm)



DWRB5

DWRB2



USE TO PROP UP MARKET TRAYS ON PG. 176-177



AS20 shown with  
MEL23 platter

AS20 shown with  
MEL12 platter

AS20 shown with  
MEL19 platter and  
RGJ4 jars

Shown with HAMSC4, BS31, B31, BH31 sauce cups and CKNF7 cheese knife

LENGTH, WIDTH AND HEIGHT ARE FULLY ADJUSTABLE



### Stainless Steel Adjustable Riser

A versatile addition to any buffet setup, this stainless steel stand can fit just about any rectangular platter. Its length, width and height can all be adjusted, making it our most adaptable riser to date.

**AS20** 12 1/4" L x 7 1/8" W x 2 7/8" H  
(31.1 x 18.1 x 7.3 cm)  
Expands up to 21" L x 11 1/2" x 4 1/8" H  
(53.3 x 29.2 x 10.5 cm)

### Three-Tier Chrome Arch Stands

An innovative step ladder design makes these stands collapsible when not in use. Check out pg. 455 to see which of our products provide a perfect fit.

**TASSM** 17 1/2" L x 6" W x 11 1/4" H  
(44.5 x 15.2 x 28.6 cm)

**TASMED** 25 1/4" L x 10 1/2" W x 13 3/4" H  
(64.1 x 26.7 x 34.9 cm)

**TASLG** 21" L x 15 1/4" W x 12 3/4" H  
(53.3 x 38.7 x 32.4 cm)

TASMED shown with CRGSQ94,  
TWBB94 and FSMEL94 bowls

TASLG shown with  
MEL19 and BAM14  
platters

TASSM shown with  
GJ24 glass jars

## IRONWORKS™ WROUGHT IRON STANDS

Available in two- and three-tier designs, these elegant wrought iron stands hold a wide range of trays, bowls, platters and baskets. Refer to pg. 454 for suggestions on the most effective product combinations. Assembly required.

### Rectangular Stands

**IS13\*** Three-Tier Stand  
 24 1/2" L x 12 9/16" W x 32 3/8" H  
 (62.2 x 31.9 x 82.2 cm)

\*Indicates oversize package for UPS

### Two-Tier Ironworks Stand

**TLSP1219** 19 3/8" L x 11 3/4" W x 12 3/8" H  
 (49.2 x 29.8 x 31.4 cm)



IS13 shown with three MWMEL21 platters



TLSP1219

Shown with GBB20 and GBB15 glacier bowls





TTREC3 shown with three MEL19 platters

### Three-Tier Foldable Stands

Elevate your presentations with our three-tier risers.

#### Rectangular

**TTREC3** Open Frame Foldable Stand  
17 3/8" L x 7 1/2" W x 10" H  
(44.1 x 19.1 x 25.4 cm)

 **TPREC3** Solid Frame Foldable Stand  
17 3/8" L x 7 1/2" W x 10" H  
(44.1 x 19.1 x 25.4 cm)

 **TTMEL3** (1) TTREC3 Open Frame Foldable Stand with  
(3) MEL19 Melamine Platters

#### Round

**TTRS3** Open Frame Foldable Stand  
14 1/8" W x 17 3/8" H  
(35.9 x 44.1 cm)

 **TTRSMEL7** (1) TTRS Open Frame Foldable Stand  
with (3) MEL7 Melamine Bowls

### Three-Tier Rectangular Stands

**IS18** Open Frame Stand  
20" L x 13 3/4" W x 12" H  
(50.8 x 34.9 x 30.5 cm)

 **ISP18** Solid Frame Stand  
20" L x 13 3/4" W x 12" H  
(50.8 x 34.9 x 30.5 cm)



TPREC3

RECTANGULAR THREE-TIER STANDS ARE AVAILABLE IN ATTRACTIVE RETAIL PACKAGING



TPREC3



ISP18







BRT3 shown with MW18, MW24 and MW32 platters

## Black Twilight Collection Modular Risers

NEW

Building a customized buffet display has never been easier with our Black Twilight Collection Modular Risers. Designed to adapt to your changing menu needs, each riser can expand a display taller, wider or longer to serve anything from a small luncheon to a large dinner party. Further personalize your look with complementary platters available in different lengths and finishes. Finally, accessorize your display with additional items from the Black Twilight Collection to provide the finishing touches.

- BRT1** Single-Tier Riser  
10" L x 10" W x 7 5/8" H  
(25.4 x 25.4 x 19.4 cm)
- BRT2** Two-Tier Riser  
10" L x 10" W x 16 1/2" H  
(25.4 x 25.4 x 41.9 cm)
- BRT3** Three-Tier Riser  
10" L x 10" W x 25 1/2" H  
(25.4 x 25.4 x 64.8 cm)



NEW



**Serving Platters** NEW

**White Marble Melamine**

**MW18** 17 3/4" L x 8 3/4" W x 5/8" H  
(45.1 x 22.2 x 1.6 cm)

**MW24** 24" L x 8 3/4" W x 5/8" H  
(61 x 22.2 x 1.6 cm)

**MW32** 31 1/2" L x 8 3/4" W x 5/8" H  
(80 x 22.2 x 1.6 cm)

**Espresso Wood**

**MWP18** 17 3/4" L x 8 3/4" W x 7/8" H  
(45.1 x 22.2 x 2.2 cm)

**MWP24** 24" L x 8 3/4" W x 7/8" H  
(61 x 22.2 x 2.2 cm)

**MWP32** 32" L x 8 3/4" W x 7/8" H  
(81.3 x 22.2 x 2.2 cm)

**Acacia Wood**

**AB189** 17 3/4" L x 8 3/4" W x 3/4" H  
(45.1 x 22.2 x 1.9 cm)

**AB249** 24" L x 8 3/4" W x 3/4" H  
(61 x 22.2 x 1.9 cm)

**AB329** 32" L x 8 3/4" W x 3/4" H  
(81.3 x 22.2 x 1.9 cm)

NEW



BRT1 and BRT2 shown with MWP18 and MWP32 platters





**BRR9** shown with **BR15** multifunctional riser and (2) **MTB156** trays

**BRR6** shown with **BR15** multifunctional riser



**BRR9** shown with **BR15** multifunctional riser and (3) **GJ40** jars

**BRR6** shown with **BR15** multifunctional riser and (3) **GJ40** jars

## Black Twilight Merchandising Risers

Build a full-service grab-and-go station or neatly organize condiments, snacks, and other buffet goodies. The possibilities are endless with these versatile and modern black metal risers. Complete the setup with our assortment of jars, baskets, and market trays.

- BRR6** 15" L x 5 1/2" W x 6" H (38.1 x 14 x 15.2 cm)
- BRR9** 15" L x 5 1/2" W x 9" H (38.1 x 14 x 22.9 cm)

### Merchandising Riser Accessories

- MSJ5** Melamine Square Jar  
44 oz. (1.3 L)  
4 7/8" Sq. x 5" H (12.4 x 12.7 cm)
- GJ40** Square Glass Jar  
40 oz. (1.2 L)  
4 3/4" Sq. x 4 7/8" H (12.1 x 12.4 cm)
- BR15** Black Twilight Multifunctional Riser  
14 3/8" L x 5 1/8" W x 2" H (37.1 x 13 x 5.1 cm)
- MTB156** Black Twilight Market Tray  
15" L x 6" W x 2" H (38.1 x 15.2 x 5.1 cm)
- MTB1512** Black Twilight Market Tray  
15" L x 12" W x 2" H (38.1 x 30.5 x 5.1 cm) (not shown)



**BRR9** shown with (3) **GJ40** jars

**BRR6** shown with (3) **GJ40** jars

BUILT IN TILTING DESIGN



CAN BE USED WITH **MSJ5** JARS



BR15 shown with GJ40 square glass jars

BR126 shown with MWML19 platter

Shown with BLHT1 tongs and CP7CL coupe plates

BR128

### Black Twilight Multifunctional Risers

Whichever way you use them, these metal risers would be a stylish, uber-versatile addition to your buffet service roster. Check out pg. 456 for accessory fit options.

**BR126** 12 1/8" L x 6 1/8" W x 2" H  
(30.8 x 15.6 x 5.1 cm)

**BR15** 14 5/8" L x 5 1/8" W x 2" H  
(37.1 x 13 x 5.1 cm)

**BR128** 12 1/8" L x 8 1/8" W x 2" H  
(30.8 x 20.6 x 5.1 cm)

### Black Twilight Two-Tiered Condiment Rack

Contemporary and sleek, this jet-black condiment organizer is an elegant way to keep toppings, sauces or straws in order. Check out pg. 456 for accessory fit options.

**BTS2** 12 3/4" L x 9" W x 6" H  
(32.4 x 22.9 x 15.2 cm)



BTS2 shown with GJ24 square glass jars, MESABUSH13 coffee urn

### Black Twilight Angled Risers

These black iron risers are modernizing buffetware design at full tilt. The unique angled construction makes self-service easier and looks striking in the process.

**ARB3** Set of 3  
6 1/2" Sq. x 5 3/4" H  
(16.5 x 14.6 cm)  
8 1/2" Sq. x 5 3/4" H  
(21.6 x 14.6 cm)  
10" Sq. x 5 3/4" H  
(25.4 x 14.6 cm)



ARB3 shown with MWMSQ7, MWMSQ9 and MWMSQ11 bowls

### Black Twilight Napkin Holder

Conveniently and compactly display napkins, guest towels and more with this sleek black napkin holder. Versatile enough to fit most decors but complements the Black Twilight Collection completely.

**NCB95** 9" L x 5" W x 4 1/2" H  
(22.9 x 12.7 x 11.4 cm)



NCB95





STS2

STS3

TTS2319 shown with  
PORD39 porcelain  
sauce cup



CRS3 shown with  
FSLT14 platter

### Stainless Steel Tier Stands

The most graceful afternoon teas and pastry parties warrant the most graceful stages. These two- and three-tier stands impress customers in any setting.

**STS2** Two-Tier Stand  
5 1/2" Dia. x 6 3/8" H  
(14 x 16.8 cm)

**STS3** Three-Tier Stand  
8 1/2" Dia. x 13" H  
(21.6 x 33 cm)

### Ascent<sup>3</sup> Three-Tier Stand

In hammered stainless steel, this three-tier stand is the ultimate in elegance.

**TTS2319** 23" Dia. x 19 3/4" H  
(58.4 x 50.2 cm)

### Curl Riser Sets

Choose from a satin or hammered finish to complete these uniquely contemporary stainless steel risers.

#### Satin

**CRS3** Set of 3  
8 1/4" L x 4" W x 2" H  
(21 x 10.2 x 5.1 cm)  
10 1/2" L x 5 1/4" W x 4" H  
(26.7 x 13.3 x 10.2 cm)  
12 1/2" L x 6" W x 6 1/2" H  
(31.8 x 15.2 x 16.5 cm)

#### Hammered

**CRH3** Set of 3  
8 1/4" L x 4" W x 2" H  
(21 x 10.2 x 5.1 cm)  
10 1/2" L x 5 1/4" W x 4" H  
(26.7 x 13.3 x 10.2 cm)  
12 1/2" L x 6" W x 6 1/2" H  
(31.8 x 15.2 x 16.5 cm)



CRH3 shown with  
GBG19 bowl

Shown with DPN9WH  
narrow rim plates  
and GVHT1 tongs



### Tiered Buffet Stands

Give your next buffet a huge wow factor with these stunning stands. In colors and shapes designed to impress, there's no better way to elevate bite-sized hors d'oeuvres and desserts to the level of luxury. Built-in plates are crafted from frosted glass.

#### Gold

**SRG3** Oval, Three-Tier Stand  
12" L x 7" W x 20 1/2" H  
(30.5 x 17.8 x 52.1 cm)  
6" and 7 1/4" Dia. Glass Plates  
(15.2 and 18.4 cm)

**SRG4** Round, Four-Tier Stand  
21 1/8" L x 6 5/8" W x 21 3/4" H  
(53.7 x 16.8 x 55.2 cm)  
6" and 7 1/4" Dia. Glass Plates  
(15.2 and 18.4 cm)

#### Silver

**SRS3** Oval, Three-Tier Stand  
12" L x 7" W x 20 1/2" H  
(30.5 x 17.8 x 52.1 cm)  
6" and 7 1/4" Dia. Glass Plates  
(15.2 and 18.4 cm)

**SRS4** Round, Four-Tier Stand  
21 1/8" L x 6 5/8" W x 21 3/4" H  
(53.7 x 16.8 x 55.2 cm)  
6" and 7 1/4" Dia. Glass Plates  
(15.2 and 18.4 cm)

#### Replacement Frosted Glass Plates

**RG6** 6" Dia. (15.2 cm)

**RG7** 7 1/4" Dia. (18.4 cm)

Shown with DPW6WH  
wide rim plates and  
WVAT1 tongs







RRG2

## Geo Riser Sets

With a sleek satin finish and minimalist design, these shimmering gold and black risers are always en vogue. Available in square and round shapes.

### Gold

**RRG2** Round, Set of 3  
 5" Dia. x 1 1/2" H (12.7 x 3.8 cm)  
 7" Dia. x 3" H (17.8 x 7.6 cm)  
 9" Dia. x 5" H (22.9 x 12.7 cm)

**RSQG2** Square, Set of 3  
 5" Sq. x 1 1/2" H (12.7 x 3.8 cm)  
 7" Sq. x 3" H (17.8 x 7.6 cm)  
 9" Sq. x 5" H (22.9 x 12.7 cm)

### Black

**RRB2** Round, Set of 3  
 5" Dia. x 1 1/2" H (12.7 x 3.8 cm)  
 7" Dia. x 3" H (17.8 x 7.6 cm)  
 9" Dia. x 5" H (22.9 x 12.7 cm)

**RSQB2** Square, Set of 3  
 5" Sq. x 1 1/2" H (12.7 x 3.8 cm)  
 7" Sq. x 3" H (17.8 x 7.6 cm)  
 9" Sq. x 5" H (22.9 x 12.7 cm)



RSQG2



RRB2



RSQB2

Shown LFTPBI2 and LFTPW12 plates

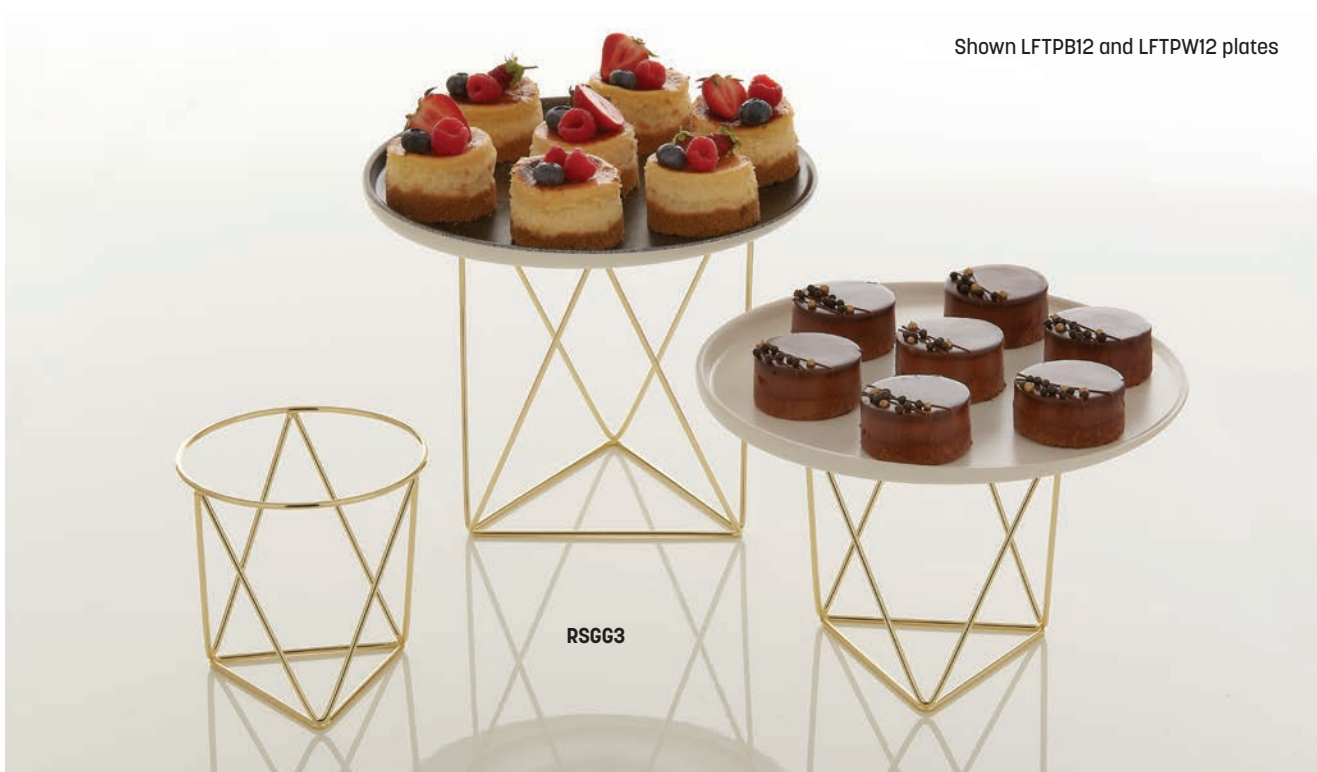

### Geometric Riser Sets

Rise to the occasion with our Geometric Risers available in multiple color options and popular heights. Combining lines, angles and shapes together in a cohesive design, these risers are versatile enough to be used with bowls, platters and serving boards.

#### Gold

- RSGG3** Set of 3  
 6" Dia. x 6" H  
 (15.2 x 15.2 cm)  
 7" Dia. x 7" H  
 (17.8 x 17.8 cm)  
 9" Dia. x 9" H  
 (22.9 x 22.9 cm)

#### Black

- RRGB3** Set of 3  
 6" Dia. x 6" H  
 (15.2 x 15.2 cm)  
 7" Dia. x 7" H  
 (17.8 x 17.8 cm)  
 9" Dia. x 9" H  
 (22.9 x 22.9 cm)

#### Stainless Steel

- RSGS3** Set of 3  
 6" Dia. x 6" H  
 (15.2 x 15.2 cm)  
 7" Dia. x 7" H  
 (17.8 x 17.8 cm)  
 9" Dia. x 9" H  
 (22.9 x 22.9 cm)







RSG3

## Gold Riser Sets

Our customers asked, and we answered. These gold risers are guaranteed crowd-pleasers. In your choice of satin finish or hammered gold.

### Satin Finish

- RSG3** Set of 3  
 6" Sq. x 4" H (15.2 x 10.2 cm)  
 7" Sq. x 6" H (17.8 x 15.2 cm)  
 8" Sq. x 8" H (20.3 x 20.3 cm)

### Hammered

- RHG1** Set of 3  
 6" Sq. x 4" H (15.2 x 10.2 cm)  
 7" Sq. x 6" H (17.8 x 15.2 cm)  
 8" Sq. x 8" H (20.3 x 20.3 cm)

## Stainless Steel Riser Sets

Individually hammered with a ball-peen hammer or in brushed satin, each riser in these sets is unique. Designed to nest for efficient storage.

### Satin Finish

- RSS3** Set of 3  
 6" Sq. x 4" H (15.2 x 10.2 cm)  
 7" Sq. x 6" H (17.8 x 15.2 cm)  
 8" Sq. x 8" H (20.3 x 20.3 cm)

### Hammered

- RSH1** Set of 3  
 6" Sq. x 4" H (15.2 x 10.2 cm)  
 7" Sq. x 6" H (17.8 x 15.2 cm)  
 8" Sq. x 8" H (20.3 x 20.3 cm)



RHG1



RSS3 shown with BG189 platter



RSH1 shown with MEL23 platter



**Acrylic Frosted Cube Riser Set**

These modern, versatile risers are a brilliant addition to all manner of tablescapes.

- AC579** Set of 3  
 5" Sq. (12.7 cm)  
 7" Sq. (17.8 cm)  
 9" Sq. (22.9 cm)

**Acrylic Riser Sets**

Simple, subtle and versatile, these risers come in sets of four in black or clear acrylic.

**Clear**

- CRS1** Set of 4  
 5" Sq. x 2" H (12.7 x 5.1 cm)  
 6" Sq. x 4" H (15.3 x 10.2 cm)  
 7" Sq. x 6" H (17.8 x 15.3 cm)  
 8" Sq. x 8" H (20.3 x 20.3 cm)

**Black**

- BRS2** Set of 4  
 5" Sq. x 2" H (12.7 x 5.1 cm)  
 6" Sq. x 4" H (15.3 x 10.2 cm)  
 7" Sq. x 6" H (17.8 x 15.3 cm)  
 8" Sq. x 8" H (20.3 x 20.3 cm)







HMPRR3

HMPRS3

SOLID-TOP, FOOD-SAFE DESIGN  
ALLOWS YOU TO SERVE DIRECTLY  
ON THE RISERS-NO PLATE NECESSARY



HMRRSET shown with  
BG1911 platter and SRCH4  
card holder

### Hammered Stainless Steel Frame Riser Sets

These three-piece riser sets are a stylish way to elevate higher-end culinary creations.

#### Solid Frame

**HMPRS3** Square, Set of 3  
6 ¾" Sq. x 3" H (17.1 x 7.6 cm)  
7 ¾" Sq. x 4" H (19.7 x 10.2 cm)  
9 ¼" Sq. x 5" H (23.5 x 12.7 cm)

**HMPRR3** Rectangle, Set of 3  
12 ¾" L x 6" W x 3 ⅛" H  
(32.4 x 15.2 x 7.9 cm)  
13 ¾" L x 7 ⅞" W x 4 ⅛" H  
(34.9 x 18.1 x 10.5 cm)  
14 ½" L x 8 ¼" W x 5 ⅛" H  
(36.8 x 21 x 13 cm)

#### Open Frame

**HMRRSET** Rectangle, Set of 3  
7 ½" L x 4 ½" W x 4 ¾" H  
(19.1 x 11.4 x 12.1 cm)  
9 ¼" L x 6" W x 6 ½" H  
(23.5 x 15.2 x 16.5 cm)  
11 ½" L x 7 ⅞" W x 7 ½" H  
(29.2 x 20 x 19.1 cm)

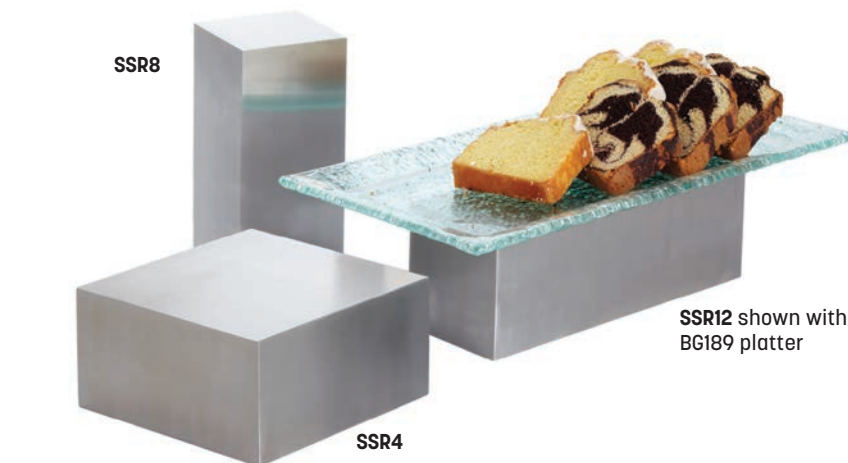

SSR8

SSR4

SSR12 shown with  
BG189 platter

### Cube Stainless Steel Risers

These brushed stainless steel risers create an upscale, contemporary look that complements even the sleekest settings.

**SSR8** 4" Sq. x 8" H (10.2 x 20.3 cm)  
**SSR12** 4" Sq. x 12" H (10.2 x 30.5 cm)  
**SSR4** 8" Sq. x 4" H (20.3 x 10.2 cm)



### Wood Frame Riser Sets

Black laquered wood in an open or solid frame works well in any buffet or banquet setting.

#### Solid Frame

**AWRSP** Square, Set of 3  
 6 3/4" Sq. x 3" H  
 (17.1 x 7.6 cm)  
 8 1/2" Sq. x 4 1/2" H  
 (21.6 x 11.4 cm)  
 10 1/4" Sq. x 6" H  
 (26 x 15.2 cm)

**AWRRP** Rectangle, Set of 3  
 13" L x 5 3/4" W x 3" H  
 (33 x 14.6 x 7.6 cm)  
 14 1/2" L x 7" W x 4 1/2" H  
 (36.8 x 17.8 x 11.4 cm)  
 16" L x 8" W x 6" H  
 (40.6 x 20.3 x 15.2 cm)

**AWRS** Rectangle, Set of 3  
 13 3/4" L x 7 3/8" W x 3 3/8" H  
 (34.9 x 18.7 x 8.6 cm)  
 17 1/2" L x 8 1/2" W x 6 1/2" H  
 (44.5 x 21.6 x 16.5 cm)  
 20 3/8" L x 11 1/4" W x 9 3/8" H  
 (51.8 x 28.6 x 23.8 cm)

#### Open Frame

**AWR10** Rectangle, Set of 3  
 13 3/4" L x 7 3/8" W x 3 3/8" H  
 (34.9 x 18.7 x 8.6 cm)  
 17 1/2" L x 8 1/2" W x 6 1/2" H  
 (44.5 x 21.6 x 16.5 cm)  
 20 3/8" L x 11 1/4" W x 9 3/8" H  
 (51.8 x 28.6 x 23.8 cm)



**AWR10**  
 shown with  
 CRGT23 and  
 CRGT21  
 platters

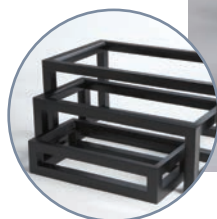

NESTS FOR EASY, ELEGANT STORAGE





RSB1 shown with CRGSQ53 and CRGSQ94 square bowls



RSM2 shown with AWMEL19 and AWMEL23 platters

### Wood Riser Sets

These geometric pieces inspire all sorts of imaginative uses. Choose from black or mahogany and create a canvas for glass, melamine, ceramic or even metal dishes.

#### Black

- RSB1** Set of 3  
 5" Sq. (12.7 cm)  
 7" Sq. (17.8 cm)  
 9" Sq. (22.9 cm)

#### Mahogany

- RSM2** Set of 3  
 5" Sq. (12.7 cm)  
 7" Sq. (17.8 cm)  
 9" Sq. (22.9 cm)



THICK ACRYLIC WALLS STAND UP TO SUBSTANTIAL WEIGHT

### Glacier Acrylic Risers

These acrylic risers look as though they've been chiseled from ice, creating an elegant stage for sushi, hors d'oeuvres and other light bites.

- AC555** 5" Sq. (12.7 cm)  
**AC777** 7" Sq. (17.8 cm)



NEW

MWR3 shown with MW24 platter, GVHT6 tongs, GCHG3 card holder and TAGA7WT chalk card

**Upton Collection**

**Arch Riser Sets** NEW

The arch. The symbol of strength and stability. The perfect shape for an elegant riser collection from American Metalcraft. Available in a set of three different sizes and heights, these espresso-finished wood risers can mix and match with other wood boards for a complete look. Even flip them upside down for an entirely different aesthetic.

- MWR3** Set of 3
  - 8 1/2" L x 5" W x 4 3/8" H (21.6 x 12.7 x 11.7 cm)
  - 10 3/8" L x 5" W x 6 3/8" H (26.4 x 12.7 x 16.2 cm)
  - 12" L x 5" W x 8" H (30.5 x 12.7 x 20.3 cm)



NEW

OPTION TO FLIP RISERS UPSIDE DOWN FOR A UNIQUE DISPLAY

**Upton Collection Crates** NEW

These wood crates are as versatile as it gets. As their name implies, use them for holding and storage. They're also a perfect way to display your most delectable baked goods, or you can turn them over to give your buffet a lift. Pair with compatible roll-top polycarbonate lids to keep foods fresh.

- MW1210** Half-Size
  - 12 3/8" L x 10 1/4" W x 2 1/2" H (31.4 x 26 x 6.4 cm)
- MW2012** Full-Size
  - 20 3/4" L x 12 5/8" W x 2 1/2" H (52.7 x 32.1 x 6.4 cm)



NEW

Shown with GVHT1 tongs, GCHG3 card holder, TAGA7WT chalk card and ARP6WH plates

CAN BE USED WITH ROLL-TOP POLYCARBONATE LIDS (PG. 220)







**RBRS3** shown with PSPL12 porcelain plate and OWBG9 serving board

### Round Bamboo Riser Set

Form and function combine with this set. Use them as risers with bowls.

- RBRS3** Set of 3  
 6" Dia. x 4" H  
 (15.2 x 10.2 cm)  
 9" Dia. x 5" H  
 (22.9 x 12.7 cm)  
 11" Dia. x 6" H  
 (27.9 x 15.2 cm)

### Bamboo Frame Riser Set

Minimalist form and natural wood color lend a whimsical, organic atmosphere to buffets. Can be used vertically or horizontally for different heights.

- BAMRSET** Set of 3  
 7 1/2" L x 4 1/4" W x 4 3/4" H  
 (19.1 x 10.8 x 12.1 cm)  
 9 1/4" L x 6 1/4" W x 6" H  
 (23.5 x 15.9 x 15.2 cm)  
 11 1/4" L x 7 1/2" W x 7 7/8" H  
 (28.6 x 19.1 x 20 cm)



**BAMRSET** shown with BD35 balti dishes on HMRT1019 and HMRT814 trays

### Bamboo Riser Sets

Some of our most popular risers, these versatile pieces inspire warmth in any setting.

#### Natural

- BAMRN1** Set of 3  
 5" Sq. x 2 1/2" H  
 (12.7 x 6.4 cm)  
 7" Sq. x 4 3/4" H  
 (17.8 x 12.1 cm)  
 9" Sq. x 6 3/8" H  
 (22.9 x 16.2 cm)

#### Dark

- BAMRD2** Set of 3  
 5" Sq. x 2 1/2" H  
 (12.7 x 6.4 cm)  
 7" Sq. x 4 3/4" H  
 (17.8 x 12.1 cm)  
 9" Sq. x 6 3/8" H  
 (22.9 x 16.2 cm)



**BAMRN1** shown with CER9 and SQB88 bowls



**BAMRD2** shown with BG159 and BG189 platters



## WOOD CRATES AND CADDIES

In multiple sizes and finishes, our line of wood crates and caddies works hard in any setting. Smaller sizes are a tasteful way to hold condiments, napkins or flatware, while larger crates are sized to fit with polycarbonate and insulated inserts. Best of all, every piece in this line can be flipped over and used as an imaginative riser. Ideal for display only. Not for transport.

### Bamboo Wood Crates and Caddies

#### Crates

- WTBA6** 1/6-Size  
6 1/4" L x 5 3/4" W x 5 3/4" H  
(15.9 x 14.6 x 14.6 cm)
- WTBA12** 1/3-Size  
12 1/4" L x 6 1/4" W x 6" H  
(31.1 x 15.9 x 15.2 cm)
- WTBA10** Half-Size  
10 1/4" L x 12 1/2" W x 8" H  
(26 x 31.8 x 20.3 cm)
- WTBA20** Full-Size  
20 1/2" L x 12 1/2" W x 8" H  
(52.1 x 31.8 x 20.3 cm)

#### Beverage Inserts

- IBT65** 1/6-Size Insulated Insert for WTBA6 (not shown)
- IBT126** 1/3-Size Insulated Insert for WTBA12 (not shown)
- IBT200** Full-Size Polycarbonate Insert for WTBA20 (not shown)

#### Caddies

- WCBA4** 3 7/8" Sq. x 4 3/4" H  
(9.8 x 12.1 cm)
- WCBA7** 7 1/2" L x 6 1/4" W x 4 3/4" H  
(19.1 x 15.9 x 12.1 cm)



Shown with **TASSM** stand, **BEE316** shaker and **TIMI** waste bin



**WARNING:** This product can expose you to chemicals including Bisphenol A (BPA), which is known to the State of California to cause birth defects or other reproductive harm. For more information, go to [www.P65warnings.ca.gov](http://www.P65warnings.ca.gov). Warning applies to State of California only.





CADDIES FIT NEATLY IN LARGER RECTANGULAR CONDIMENT RACKS LIKE OUR BWC12 ON PG. 109

## Vintage Wood Crates and Caddies

### Crates

- WTV6** 1/6-Size  
6 1/4" L x 5 3/4" W x 5 3/4" H  
(15.9 x 14.6 x 14.6 cm)
- WTV12** 1/3-Size  
12 1/4" L x 6 1/4" W x 6" H  
(31.1 x 15.9 x 15.2 cm)
- WTV10** Half-Size  
10 1/4" L x 12 1/2" W x 8" H  
(26 x 31.8 x 20.3 cm)
- WTV20** Full-Size  
20 1/2" L x 12 1/2" W x 8" H  
(52.1 x 31.8 x 20.3 cm)
- WCVL** 17 3/8" L x 9 1/8" W x 2 3/8" H  
(44.1 x 23.2 x 6 cm)
- WCVS** 9" Sq. x 2 3/8" H  
(22.9 x 6 cm)

### Beverage Inserts

- IBT65** 1/6-Size Insulated Insert for WTV6
- IBT126** 1/3-Size Insulated Insert for WTV12
- IBT200** Full-Size Polycarbonate Insert for WTV20

### Caddies

- WCV4** 3 7/8" Sq. x 4 3/4" H  
(9.8 x 12.1 cm)
- WCV7** 7 1/2" L x 6 1/4" W x 4 3/4" H  
(19.1 x 15.9 x 12.1 cm)



**WARNING:** This product can expose you to chemicals including Bisphenol A (BPA), which is known to the State of California to cause birth defects or other reproductive harm. For more information, go to [www.P65warnings.ca.gov](http://www.P65warnings.ca.gov). Warning applies to State of California only.

## Black Wood Crates and Caddies

### Crates

- WTBL6** 1/6-Size  
6 1/4" L x 5 3/4" W x 5 3/4" H  
(15.9 x 14.6 x 14.6 cm)
- WTBL12** 1/3-Size  
12 1/4" L x 6 1/4" W x 6" H  
(31.1 x 15.9 x 15.2 cm)
- WTBL10** Half-Size  
10 1/4" L x 12 1/2" W x 8" H  
(26 x 31.8 x 20.3 cm)
- WTBL20** Full-Size  
20 1/2" L x 12 1/2" W x 8" H  
(52.1 x 31.8 x 20.3 cm)

### Beverage Inserts

- IBT65** 1/6-Size Insulated  
Insert for WTBL6
- IBT126** 1/3-Size Insulated  
Insert for WTBL12
- IBT200** Full-Size Polycarbonate  
Insert for WTBL20

### Caddies

- WCBL4** 3 7/8" Sq. x 4 3/4" H  
(9.8 x 12.1 cm)
- WCBL7** 7 1/2" L x 6 1/4" W x 4 3/4" H  
(19.1 x 15.9 x 12.1 cm)

## Black Twilight Nestable

### Baskets

Organizing, displaying and storing has never been so stylish. These nestable, power-house baskets do it all. Perfect for keeping cups and dinnerware in the perfect places in dining halls or for displaying point of purchase snack options. Even use with beverage inserts to serve and chill drinks!

- BNRB6** 1/6-Size, 6 7/8" L x 6 3/8" W x 6" H  
(17.5 x 16.2 x 15.2 cm)
- BNRB126** 1/3-Size, 12 1/2" L x 6 1/2" W x 6" H  
(31.8 x 16.5 x 15.2 cm)
- BNRB129** Half-Size, 12 1/8" L x 10" W x 8" H  
(30.8 x 25.4 x 20.3 cm)
- BNRB20** Full-Size, 20 3/8" L x 12 3/8" W x 8" H  
(51.8 x 31.4 x 20.3 cm)

### Beverage Inserts

- IBT65** 1/6-Size Insulated  
Insert for BNRB6
- IBT126** 1/3-Size Insulated  
Insert for BNRB126
- IBT125** Half-Size Insulated  
Insert for BNRB129
- IBT200** Full-Size Insulated  
Insert for BNRB20



AN EASY WAY TO ELEVATE  
DINING HALL PRESENTATION



**WARNING:** This product can expose you to chemicals including Bisphenol A (BPA), which is known to the State of California to cause birth defects or other reproductive harm. For more information, go to [www.P65warnings.ca.gov](http://www.P65warnings.ca.gov). Warning applies to State of California only.





BEVDG20 shown with IBT200 liner

BEVDG129 shown with IBT125 liner

TUBS CAN BE FITTED WITH INSULATED AND POLYCARBONATE INSERTS

BEVDG6

BEVDG126 shown with IBT126 liner



BEVG129

BEVG20

BEVG6

BEVG126

## Galvanized Beverage Tubs

In your choice of two galvanized colors, our beverage tubs are useful wherever thirst needs to be quenched en masse. These tubs have a tapered design for easy storage.

### Onyx

- BEVDG6** 1/6-Size, 6" L x 6 1/4" W x 5 3/4" H (15.2 x 15.9 x 14.6 cm)
- BEVDG126** 1/3-Size, 12 1/4" L x 6" W x 5 3/4" H (31.1 x 15.2 x 14.6 cm)
- BEVDG129** Half-Size, 12 1/2" L x 9 7/8" W x 7 7/8" H (31.8 x 25.1 x 20 cm)
- BEVDG20** Full-Size, 20 1/2" L x 12" W x 8" H (52.1 x 30.5 x 20.3 cm)

### Silver

- BEVG6** 1/6-Size, 6" L x 6 1/4" W x 5 3/4" H (15.2 x 15.9 x 14.6 cm)
- BEVG126** 1/3-Size, 12 1/4" L x 6" W x 5 3/4" H (31.1 x 15.2 x 14.6 cm)
- BEVG129** Half-Size, 12 1/2" L x 9 7/8" W x 7 7/8" H (31.8 x 25.1 x 20 cm)
- BEVG20** Full-Size, 20 1/2" L x 12" W x 8" H (52.1 x 30.5 x 20.3 cm)

### Beverage Inserts

- IBT65** 1/6-Size Insulated Insert
- IBT126** 1/3-Size Insulated Insert
- IBT125** Half-Size Polycarbonate Insert
- IBT200** Full-Size Polycarbonate Insert



**WARNING:** This product can expose you to chemicals including Bisphenol A (BPA), which is known to the State of California to cause birth defects or other reproductive harm. For more information, go to [www.P65warnings.ca.gov](http://www.P65warnings.ca.gov). Warning applies to State of California only.



BEV820 shown  
with IBT200 liner

BEVB556 shown  
with IBT65 liner

BEVB6612 shown  
with IBT126 liner



BEV1220

BEVC1266 shown  
with IBT126 liner

BEVC655 shown  
with IBT65 liner

## Rectangular Hammered Tubs

Perfect for cafeterias, parties and buffets, these stylishly retro hammered tubs can be fitted with insulated and polycarbonate inserts.

### Black

**BEVB556** 1/6-Size, 6 1/4" L x 5 3/4" W x 5 3/4" H  
(15.9 x 14.6 x 14.6 cm)

**BEVB6612** 1/3-Size, 12 1/4" L x 6 1/4" W x 6" H  
(31.1 x 15.9 x 15.2 cm)

**BEV820** Full-Size, 20 1/2" L x 12 1/2" W x 8" H  
(52.1 x 31.8 x 20.3 cm)

### Copper

**BEVC655** 1/6-Size, 6 1/4" L x 5 3/4" W x 5 3/4" H  
(15.9 x 14.6 x 14.6 cm)

**BEVC1266** 1/3-Size, 12 1/4" L x 6 1/4" W x 6" H  
(31.1 x 15.9 x 15.2 cm)

**BEV1220** Full-Size, 20 1/2" L x 12 1/2" W x 8" H  
(52.1 x 31.8 x 20.3 cm)

### Beverage Inserts

**IBT65** 1/6-Size Insulated Insert

**IBT126** 1/3-Size Insulated Insert

**IBT200** Full-Size Polycarbonate Insert



**WARNING:** This product can expose you to chemicals including Bisphenol A (BPA), which is known to the State of California to cause birth defects or other reproductive harm. For more information, go to [www.P65warnings.ca.gov](http://www.P65warnings.ca.gov). Warning applies to State of California only.





ATHC9

ATHC14

ATHC10

ATHC16 shown with the ACS cocktail shaker, WC40 water carafe, ACT Moscow mule mug and BB2 glass bitters bottle



ATHG9

ATHG14

ATHG10

ATHG16

## Hammered Aluminum Beverage Tubs and Trays

Add a bit of charm to any occasion—from your next brunch buffet to a private table service for two. Available in multiple sizes, our Hammered Aluminum Beverage Tubs and Trays come in beautiful finishes for a striking look wherever they're placed.

### Copper

- ATHC16** Tray, 16" Dia. x 2 ¾" H  
(40.6 x 7 cm)
- ATHC9** Tub, 7 ¾ qt. (7.3 L)  
12 ¼" L x 9" W x 8 ¾" H  
(31.1 x 22.9 x 22.2 cm)
- ATHC10** Tub, 10 qt. (9.5 L)  
15" L x 10 ¾" W x 7 ¼" H  
(38.1 x 27.3 x 18.4 cm)
- ATHC14** Tub, 16 ¼ qt. (15.4 L)  
19" L x 14" W x 8 ¼" H  
(48.2 x 35.6 x 21 cm)

### Gold

- ATHG16** Tray, 16" Dia. x 2 ¾" H  
(40.6 x 7 cm)
- ATHG9** Tub, 7 ¾ qt. (7.3 L)  
12 ¼" L x 9" W x 8 ¾" H  
(31.1 x 22.9 x 22.2 cm)
- ATHG10** Tub, 10 qt. (9.5 L)  
15" L x 10 ¾" W x 7 ¼" H  
(38.1 x 27.3 x 18.4 cm)
- ATHG14** Tub, 16 ¼ qt. (15.4 L)  
19" L x 14" W x 8 ¼" H  
(48.2 x 35.6 x 21 cm)

### Silver

- ATHS16** Tray, 16" Dia. x 2 ¾" H  
(40.6 x 7 cm)
- ATHS9** Tub, 7 ¾ qt. (7.3 L)  
12 ¼" L x 9" W x 8 ¾" H  
(31.1 x 22.9 x 22.2 cm)
- ATHS10** Tub, 10 qt. (9.5 L)  
15" L x 10 ¾" W x 7 ¼" H  
(38.1 x 27.3 x 18.4 cm)
- ATHS14** Tub, 16 ¼ qt. (15.4 L)  
19" L x 14" W x 8 ¼" H  
(48.2 x 35.6 x 21 cm)

### Black

- ATHB16** Tray, 16" Dia. x 2 ¾" H  
(40.6 x 7 cm)
- ATHB9** Tub, 7 ¾ qt. (7.3 L)  
12 ¼" L x 9" W x 8 ¾" H  
(31.1 x 22.9 x 22.2 cm)
- ATHB10** Tub, 10 qt. (9.5 L)  
15" L x 10 ¾" W x 7 ¼" H  
(38.1 x 27.3 x 18.4 cm)
- ATHB14** Tub, 16 ¼ qt. (15.4 L)  
19" L x 14" W x 8 ¼" H  
(48.2 x 35.6 x 21 cm)







## Black Wood Signs

Triangular wooden blocks feature sleek silver labels. Each measures 3" W x 1 3/4" H (7.6 x 4.4 cm).

- SIGNIT2** Iced Tea Sign
- SIGNSK9** Skim Milk Sign
- SIGND4** Decaf Sign
- SIGNC3** Coffee Sign
- SIGNHT1** Hot Tea Sign
- SIGNCR11** Cream Sign
- SIGNM8** Milk Sign
- SIGNW5** Hot Water Sign
- SIGNR6** Reserved Double-Sided Sign
- SIGNS7** No Smoking Double-Sided Sign
- SIGNCO** Carry-Out Pickup Double-Sided Sign

## Laser Cut Signs

### Silver

- SSD5** Decaf Sign  
5" L x 3/4" W x 1 1/4" H  
(12.7 x 1.9 x 3.2 cm)
- SSR5** Reserved Sign  
5" L x 3/4" W x 1 1/4" H  
(12.7 x 1.9 x 3.2 cm)
- SSC5** Coffee Sign  
5" L x 3/4" W x 1 1/4" H  
(12.7 x 1.9 x 3.2 cm)
- SSHW5** Hot Water Sign  
5" L x 3/4" W x 1 1/4" H  
(12.7 x 1.9 x 3.2 cm)

### Black

- SBD5** Decaf Sign  
5" L x 3/4" W x 1 1/4" H  
(12.7 x 1.9 x 3.2 cm)
- SBR5** Reserved Sign  
5" L x 3/4" W x 1 1/4" H  
(12.7 x 1.9 x 3.2 cm)
- SBC5** Coffee Sign  
5" L x 3/4" W x 1 1/4" H  
(12.7 x 1.9 x 3.2 cm)
- SBHW5** Hot Water Sign  
5" L x 3/4" W x 1 1/4" H  
(12.7 x 1.9 x 3.2 cm)



### Stainless Steel Card Sign

This semicircular stainless steel menu card makes it easy to write on with a Securit Chalk Marker (pg. 321).

**SMS1** 5" L x 2 1/2" W x 2 5/8" H  
(12.7 x 6.4 x 6.7 cm)



SMS1

### Stainless Steel Three-Sided Signs

With three messages on every sign, this is an easy way to identify with minimal effort.

**TTSVG3** Vegan/Vegetarian/Gluten Free  
4 3/4" L x 1 1/2" W x 1 3/8" H  
(12.1 x 3.8 x 3.5 cm)

**TTSB3** Coffee/Decaf/Hot Water  
4 3/4" L x 1 1/2" W x 1 3/8" H  
(12.1 x 3.8 x 3.5 cm)

**TTMC3** Milk/Cream/Skim  
4 3/4" L x 1 1/2" W x 1 3/8" H  
(12.1 x 3.8 x 3.5 cm)



TTSVG3

### Reserved Signs

Printed on both sides with classic, easily legible lettering.

**2600** Plastic Standard Weight  
6" L x 2" H (15.2 x 5.1 cm)

**2601H** Acrylic Heavy Weight  
6" L x 2" H (15.2 x 5.1 cm)



2600



2601H



TTSB3



TTMC3





### Deluxe Reservation Stands and Card Holders

CH Series made of all stainless steel. Weighted base measures 2 3/8" (6.7 cm). RS Series made of stainless steel with heavy weighted base. Mirror finish, 3 3/8" base (9.2 cm).

- CH4 4" H (10.2 cm)
- CH6 6" H (15.3 cm)
- CH8 8" H (20.3 cm)
- CH10 10" H (25.4 cm)
- RS12 12" H (30.5 cm)
- RS18 18" H (45.7 cm)

### Low-Profile Menu and Card Holders

Choose from a range of styles and materials to match your dining room aesthetic.

- MH243** Nickel-Plated  
2 1/4" Dia. x 2 1/2" H (5.7 x 6.4 cm)
- BMH221** Black Metal  
1 1/2" Dia. x 1 1/2" H (3.8 x 3.8 cm)
- MH220** Stainless Steel  
1 1/2" Dia. x 1 1/2" H (3.8 x 3.8 cm)

### Heavy Plastic Table Numbers

If speed is the name of your game, it's hard to beat easily legible black numbers on heavy white plastic. Each measures 4" (10.2 cm) square.

- 450** Nos. 1-50
- 4100** Nos. 1-100
- 4150** Nos. 101-150

### Mini Stainless Steel Number Tents

A stylish alternative to classic table numbers, these double-sided, embossed tents are crafted from dishwasher-safe, heat-tolerant stainless steel. 1" Sq. x 1 1/2" W (2.5 x 3.8 cm)

- EM199** Nos. 1-99
- EM1200** Nos. 1-200
- EM200** Nos. 201-400
- EM400** Nos. 401-600



MH243



BMH221

MH220



450

DOUBLE-SIDED FOR RAPID IDENTIFICATION

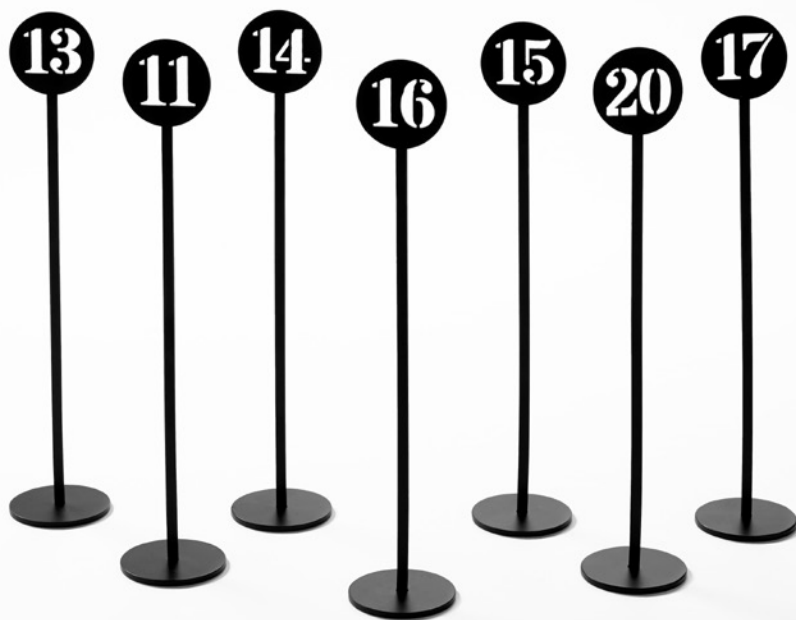

EM199

Stands shown from **NSB20**

### Laser Cut Number Stands

The stamped-out numbers in these stands deliver more pizzazz than your average table-markers. In your choice of black or silver. 2" Dia. x 10" H (5.1 x 25.4 cm)

#### Black

- NSB10** Nos. 1-10
- NSB20** Nos. 11-20
- NSB30** Nos. 21-30
- NSB40** Nos. 31-40
- NSB50** Nos. 41-50

#### Silver

- NSC10** Nos. 1-10
- NSC20** Nos. 11-20
- NSC30** Nos. 21-30
- NSC40** Nos. 31-40
- NSC50** Nos. 41-50

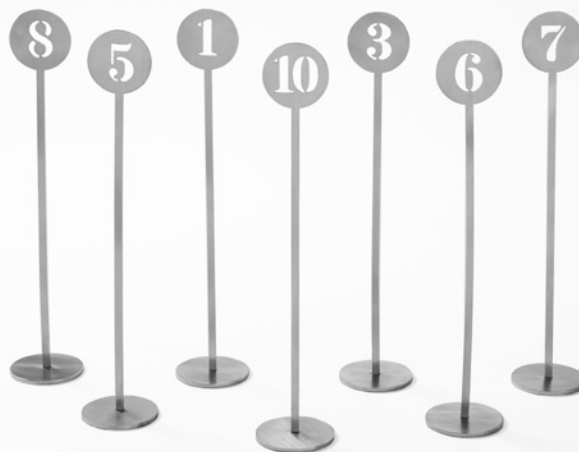
Stands shown from **NSC10**



## Harp Weighted Number Stands

### Gold

- HPG4** 2 ¼" Dia. x 4" H  
(5.7 x 10.2 cm)
- HPG6** 2 ¼" Dia. x 6" H  
(5.7 x 15.2 cm)
- HPG8** 2 ¼" Dia. x 8" H  
(5.7 x 20.3 cm)
- HPG12** 2 ¼" Dia. x 12" H  
(5.7 x 30.5 cm)
- HPG18** 2 ¼" Dia. x 18" H  
(5.7 x 45.7 cm)

### Black

- HPBL4** 2 ¼" Dia. x 4" H  
(5.7 x 10.2 cm)
- HPBL6** 2 ¼" Dia. x 6" H  
(5.7 x 15.2 cm)
- HPBL8** 2 ¼" Dia. x 8" H  
(5.7 x 20.3 cm)
- HPBL12** 2 ¼" Dia. x 12" H  
(5.7 x 30.5 cm)
- HPBL18** 2 ¼" Dia. x 18" H  
(5.7 x 45.7 cm)

### Chrome

- HPCH4** 2 ¼" Dia. x 4" H  
(5.7 x 10.2 cm)
- HPCH6** 2 ¼" Dia. x 6" H  
(5.7 x 15.2 cm)
- HPCH8** 2 ¼" Dia. x 8" H  
(5.7 x 20.3 cm)
- HPCH12** 2 ¼" Dia. x 12" H  
(5.7 x 30.5 cm)
- HPCH18** 2 ¼" Dia. x 18" H  
(5.7 x 45.7 cm)

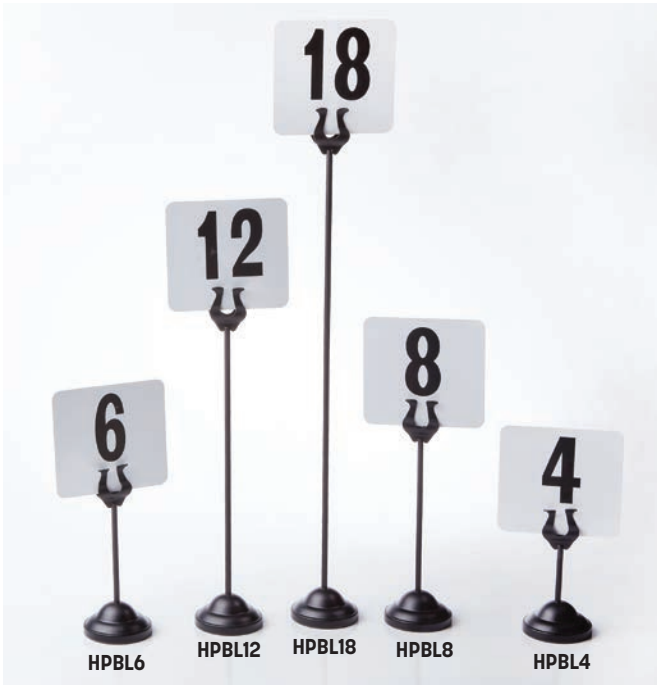

## Geometric Card Holders

Display anything from menu cards to QR codes with these abstractly designed Geometric Card Holders. Available in popular colors and a variety of height options.

### Silver

**GCHS2** 1 3/4" L x 1 1/8" W x 2" H  
(4.4 x 2.9 x 5.1 cm)

**GCHS3** 2 5/8" L x 1 5/8" W x 3" H  
(6.7 x 4.1 x 7.6 cm)

**GCHS4** 3 1/2" L x 2" W x 4" H  
(8.9 x 5.1 x 10.2 cm)

### Black

**GCHB2** 1 3/4" L x 1 1/8" W x 2" H  
(4.4 x 2.9 x 5.1 cm)

**GCHB3** 2 5/8" L x 1 5/8" W x 3" H  
(6.7 x 4.1 x 7.6 cm)

**GCHB4** 3 1/2" L x 2" W x 4" H  
(8.9 x 5.1 x 10.2 cm)

### Gold

**GCHG2** 1 3/4" L x 1 1/8" W x 2" H  
(4.4 x 2.9 x 5.1 cm)

**GCHG3** 2 5/8" L x 1 5/8" W x 3" H  
(6.7 x 4.1 x 7.6 cm)

**GCHG4** 3 1/2" L x 2" W x 4" H  
(8.9 x 5.1 x 10.2 cm)

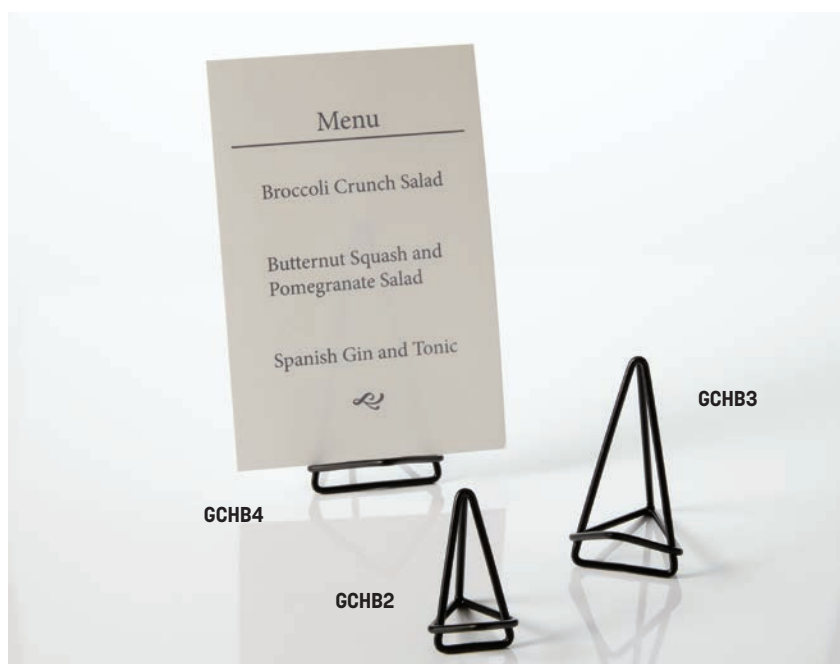





## Chrome Spiral Number Holders

This playfully imaginative, spring-like design is available in two sizes.

**SNC1** 2 3/8" Dia. x 3" H  
(6 x 7.6 cm)

**MHSC6** 2 1/4" Dia. x 6" H  
(5.7 x 15.2 cm)

## Swirl Base Number Stands

### Chrome

**NSC1** 2" Dia. x 1 1/2" H  
(5.1 x 3.8 cm)

**NSC4** 2 1/2" Dia. x 4" H  
(6.4 x 10.2 cm)

**NSC6** 2 1/2" Dia. x 6" H  
(6.4 x 15.2 cm)

**NSC8** 3" Dia. x 8" H  
(7.6 x 20.3 cm)

**NSC12** 4" Dia. x 12" H  
(10.2 x 30.5 cm)

### Black

**NSB1** 2" Dia. x 1 1/2" H  
(5.1 x 3.8 cm)

**NSB4** 2 1/2" Dia. x 4" H  
(6.4 x 10.2 cm)

**NSB6** 2 1/2" Dia. x 6" H  
(6.4 x 15.2 cm)

**NSB8** 3" Dia. x 8" H  
(7.6 x 20.3 cm)

**NSB12** 4" Dia. x 12" H  
(10.2 x 30.5 cm)

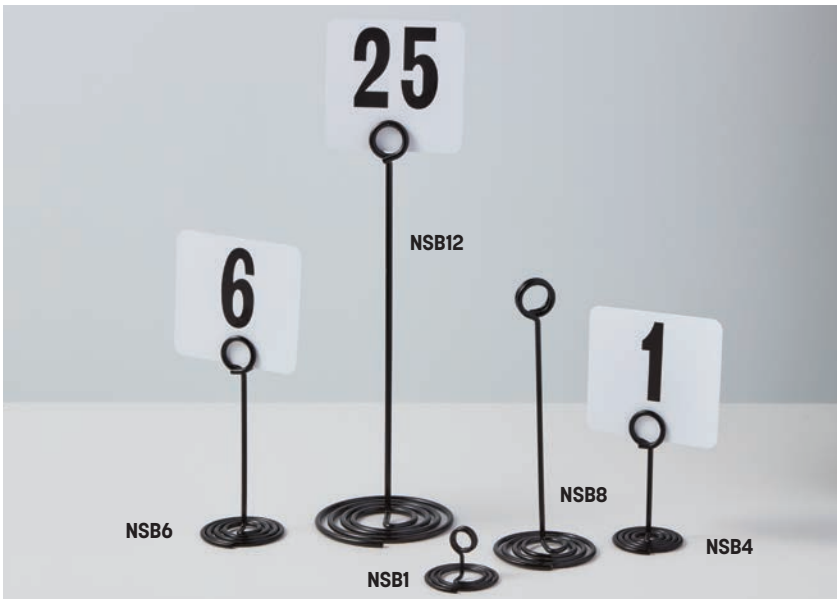
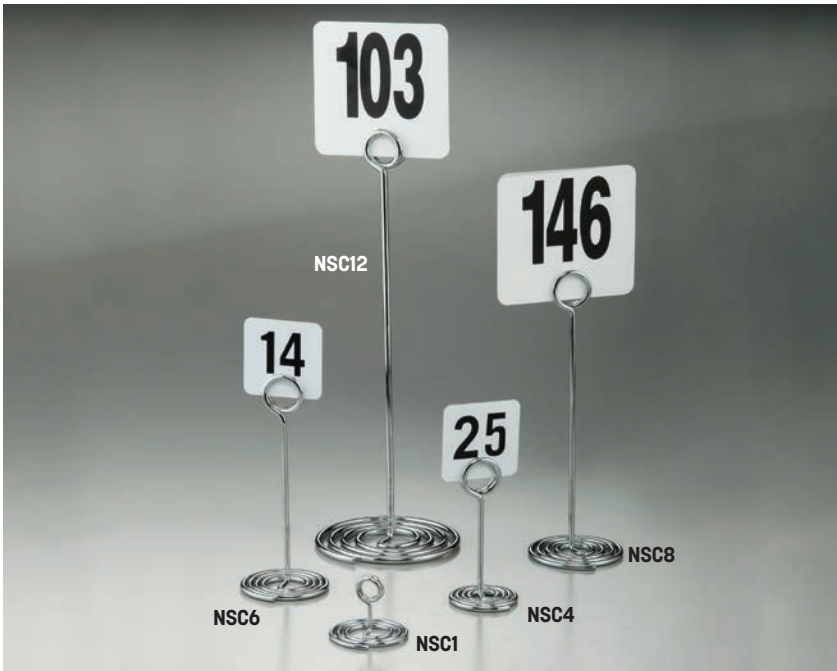

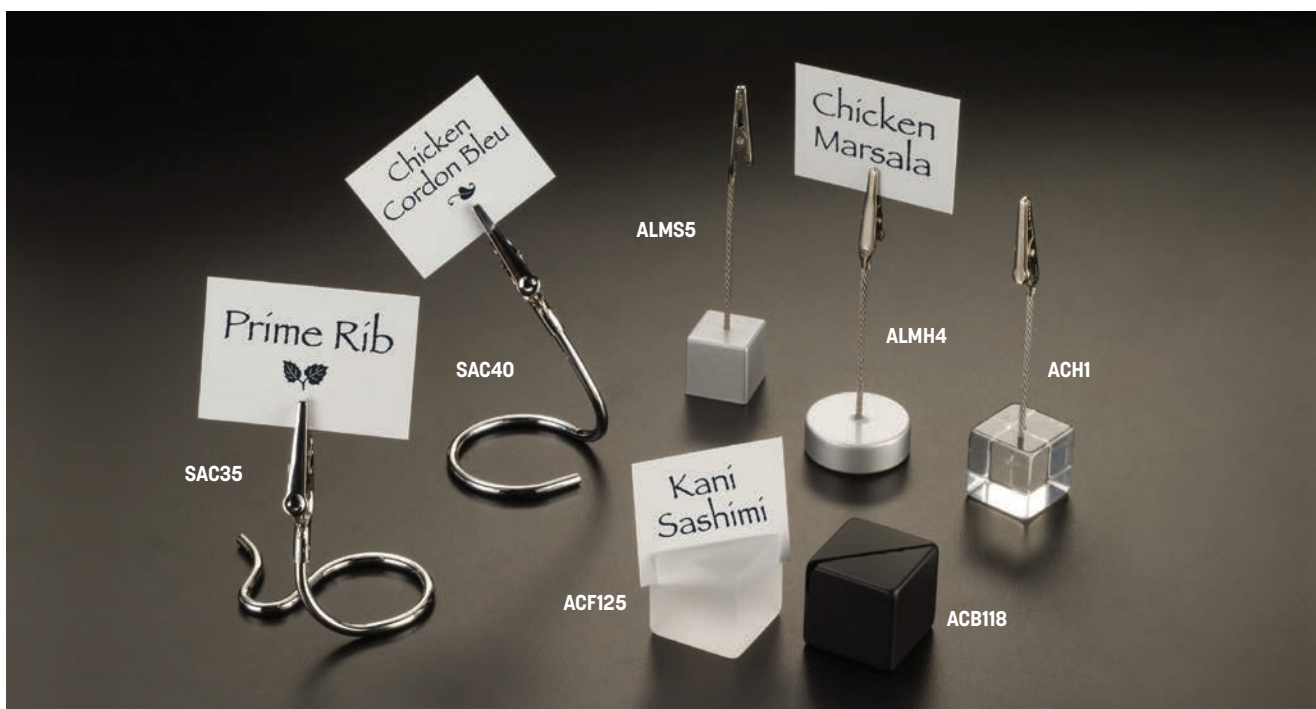

## Card Holders

Choose from snappy alligator clips or sophisticated cubes to label buffets in a distinctive, contemporary way.

### Swirly Alligator Clip Card Holders

**SAC40** "C" Design  
4" H (10.2 cm)

**SAC35** "S" Design  
3 ½" H (8.9 cm)

### Aluminum Alligator Clip Card Holders

**ALMH4** Round  
4 ¼" H (10.8 cm)

**ALMS5** Square  
4 ¼" H (10.8 cm)

### Acrylic Alligator Clip Card Holder

**ACH1** Square  
4 ¼" H (10.8 cm)

### Acrylic Cube Card Holders

**ACF125** Frosted White  
1 ½" Sq. (2.9 cm)

**ACB118** Black  
1 ½" Sq. (2.9 cm)

### Double-Sided Flexible Sign Clip

Clip these flexible, gravity-defying markers on trays, platters or bowls.

**CLIPIT2** 5 ¼" L x ½" W  
(13.3 x 1.3 cm)

**CLIPIT6** 6" L x ½" W  
(15.2 x 1.3 cm)



CLIPIT2 shown with TAGA8WT and TAGA7WT mini chalk cards





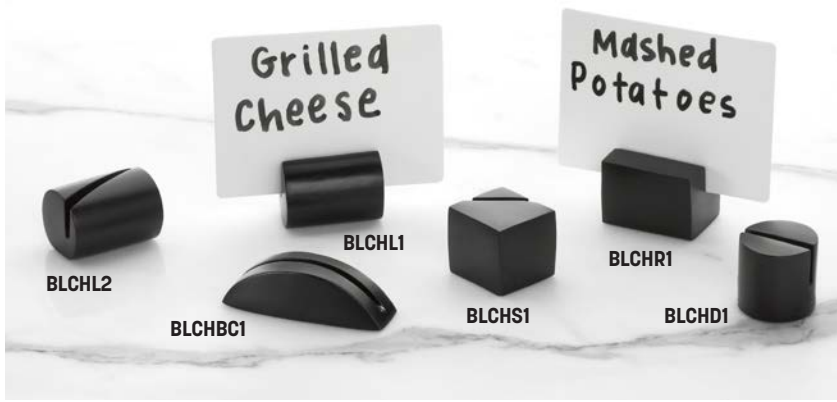

## Hammered Aluminum Card Holders ▶

Each aspect of these head-turning designs is purposeful. Small stature keeps table space open, while hammered aluminum is heavy enough to stay in place.

### Black

- BLCHL2** Angled Cut Cylinder  
1 1/4" L x 7/8" W x 7/8" H  
(3.2 x 2.2 x 2.2 cm)
- BLCHL1** Cylinder  
1 1/4" L x 7/8" W x 7/8" H  
(3.2 x 2.2 x 2.2 cm)
- BLCHBC1** Half Moon  
2 1/8" L x 3/4" W x 3/4" H  
(5.4 x 1.9 x 1.9 cm)
- BLCHS1** Angled Cut Square  
7/8" Sq. (2.2 cm)
- BLCHR1** Rectangular  
1" L x 1 1/4" W x 1" H  
(2.5 x 3.2 x 2.5 cm)
- BLCHD1** Round  
7/8" Dia. x 3/4" H  
(2.2 x 1.9 cm)

### Silver

- HCHL2** Angled Cut Cylinder  
1 1/4" L x 7/8" W x 7/8" H  
(3.2 x 2.2 x 2.2 cm)
- HCHL1** Cylinder  
1 1/4" L x 7/8" W x 7/8" H  
(3.2 x 2.2 x 2.2 cm)
- HCHBC1** Half Moon  
2 1/8" L x 3/4" W x 3/4" H  
(5.4 x 1.9 x 1.9 cm)
- HCHS1** Angled Cut Square  
7/8" Sq. (2.2 cm)
- HCHR1** Rectangular  
1" L x 1 1/4" W x 1" H  
(2.5 x 3.2 x 2.5 cm)
- HCHD1** Round  
7/8" Dia. x 3/4" H  
(2.2 x 1.9 cm)

### Copper

- BHCHL2** Angled Cut Cylinder  
1 1/4" L x 7/8" W x 7/8" H  
(3.2 x 2.2 x 2.2 cm)
- BHCHL1** Cylinder  
1 1/4" L x 7/8" W x 7/8" H  
(3.2 x 2.2 x 2.2 cm)
- BHCHBC1** Half Moon  
2 1/8" L x 3/4" W x 3/4" H  
(5.4 x 1.9 x 1.9 cm)
- BHCHS1** Angled Cut Square  
7/8" Sq. (2.2 cm)
- BHCHR1** Rectangular  
1" L x 1 1/4" W x 1" H  
(2.5 x 3.2 x 2.5 cm)
- BHCHD1** Round  
7/8" Dia. x 3/4" H  
(2.2 x 1.9 cm)

## Cast Aluminum Card Holder ▶

- BC1** Half Moon  
2 1/8" L x 3/4" W x 3/4" H  
(5.4 x 1.9 x 1.9 cm)

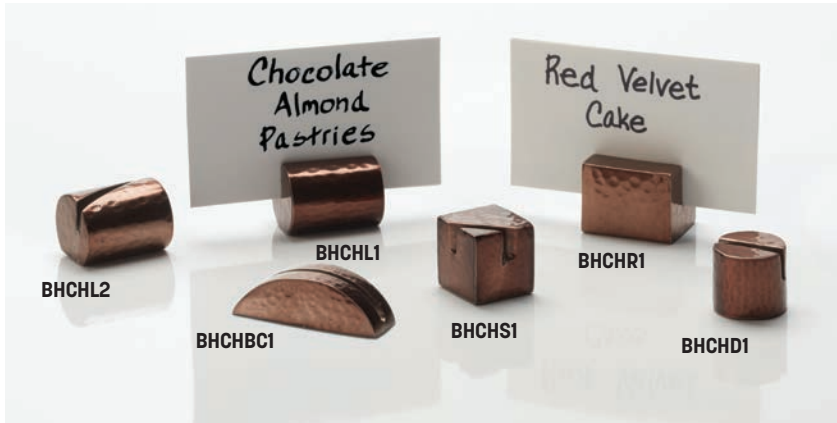

BC1 shown with TAGA7WT mini chalk card

MCHW125 shown with TAGA6WT chalk card

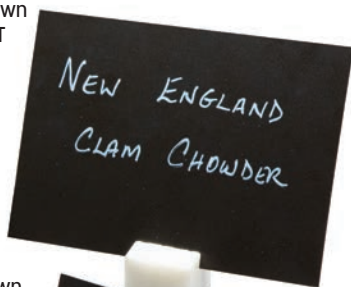

MCHB125 shown with TAGA8WT chalk card



SRCH125

SRCH4 shown with TAGA7WT mini chalk card

### Marble Card Holders

Add a touch of elegance to any setting with black or white marble.

**MCHB125** Black  
1 1/4" Sq. x 1" H  
(3.2 x 2.5 cm)

**MCHW125** White  
1 1/4" Sq. x 1" H  
(3.2 x 2.5 cm)

### Round Rod Card Holders

Brushed stainless steel and minimalistic design resonate elegance. Fit a variety of card sizes in the 1/4" (0.64 cm) slit.

**SRCH125** 1 1/4" L x 5/8" H  
(3.2 x 1.6 cm)

**SRCH4** 4" L x 5/8" H  
(10.2 x 1.6 cm)



SSCH4 and SSCH125 shown with TAGA7WT mini chalk card

PERFECT FIT FOR MINI CHALK CARDS (PG. 321)

### Square Rod Card Holders

Simple and functional, these stainless steel pieces hold all manner of cards.

#### Silver

**SSCH125** 3/8" Sq. x 1 1/2" L  
(1 x 3.8 cm)

**SSCH4** 3/8" Sq. x 4 1/8" L  
(1 x 10.5 cm)

#### Black

**BCH125** 3/8" Sq. x 1 1/2" L  
(1 x 3.8 cm)

**BCH4** 3/8" Sq. x 4 1/8" L  
(1 x 10.5 cm)



BCH4

BCH125

### Stainless Steel Card Holders

Clever design takes up minimal table space, while brushed stainless steel is effortlessly cool.

**DXCH1** 2" L x 2" W x 3/4" H  
(5.1 x 5.1 x 1.9 cm)



DXCH1



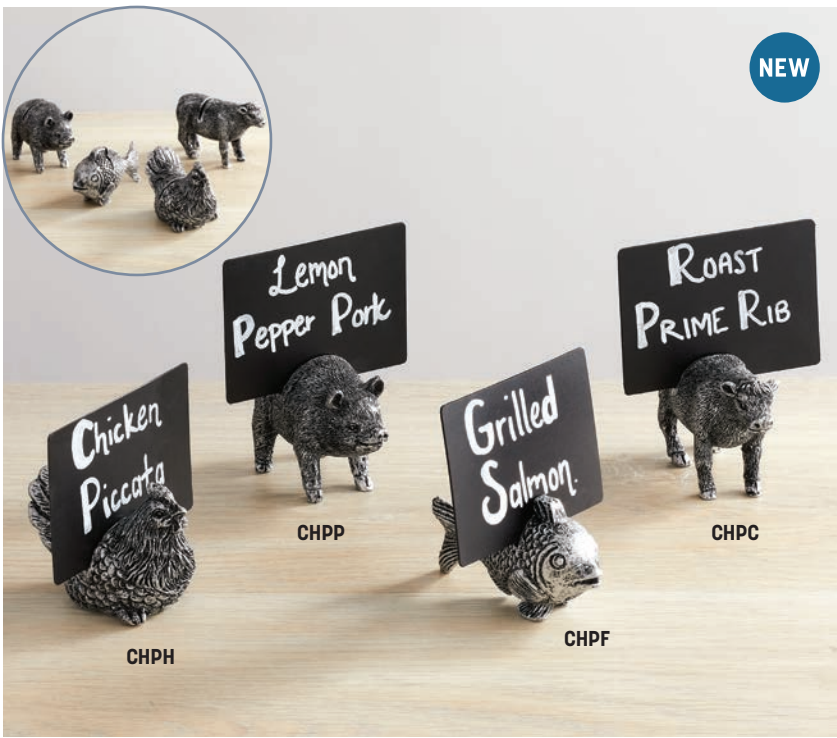

NEW

### Whimsical Card Holders NEW

Add a touch of whimsy to your buffet! Featuring our favorite farmhouse friends, these card holders can creatively label corresponding dishes on the buffet or hold promotional menu specials or place cards on the tabletop.

- CHPH** Hen  
2 3/8" L x 1 1/2" W x 1 7/8" H  
(6 x 3.8 x 4.8 cm)
- CHPP** Pig  
2 5/8" L x 1 1/2" W x 1 3/4" H  
(6.7 x 3.8 x 4.4 cm)
- CHPF** Fish  
2 3/4" L x 1 1/4" W x 1 5/8" H  
(7 x 3.2 x 4.1 cm)
- CHPC** Cow  
3" L x 1 3/8" W x 2" H  
(7.6 x 3.5 x 5.1 cm)

### Stone Card Holders

As though they've been plucked from a riverbed, these card holders create a fun, organic effect.

- CHBS** Black  
1 1/4" L x 1" W x 1/2" H  
(3.2 x 2.5 x 1.3 cm)
- CHGS** Gray  
1 1/4" L x 1" W x 1/2" H  
(3.2 x 2.5 x 1.3 cm)



### Acrylic Card Holder Set

Fifty contemporary clear acrylic card holders in a convenient carrying case. **Sold in a set of 50.**

- LK50** 1 1/4" L x 1" W x 1/4" H  
(3.2 x 2.5 x 0.6 cm)



LK50

Shown with TAGA8WT mini chalk card

INCLUDES CARRYING CASE THAT HOLDS ALL FIFTY CARD HOLDERS



BAMBL125

BAMCH125

BAMBL4

BAMCH4 shown with  
TAGA7WT mini  
chalk card

### Bamboo Card Holders

Clean lines and contemporary styling draws customers' eyes to the cards.

**BAMBL125** Black  
1¼" L x 1½" W x ¾" H  
(3.2 x 2.9 x 1.9 cm)

**BAMCH125** Natural  
1¼" L x 1½" W x ¾" H  
(3.2 x 2.9 x 1.9 cm)

**BAMBL4** Black  
4" L x 1½" W x ¾" H  
(10.2 x 2.9 x 1.9 cm)

**BAMCH4** Natural  
4" L x 1½" W x ¾" H  
(10.2 x 2.9 x 1.9 cm)

### Square Wood Card Holders

In olive wood or walnut, these cubes with rounded corners measure 1½" Sq. (2.9 cm).

**SOCH** Olive Wood

**SWCH** Walnut

Shown with HMST20  
hammered tray

SOCH

SWCH





CMCSW2

USE SECURIT MARKERS  
(PG. 321) ON ANY OF  
THESE SIGNS



CMP553

CMP520

CMP425

### Geometric Ceramic Card Signs

Write, wipe, repeat. These ceramic signs are endlessly reusable and appropriate for all levels of formality.

- CMCSW2** Rectangle  
5" L x 2 1/4" W x 2 1/2" H  
(12.7 x 5.7 x 6.4 cm)
- CMP553** Rectangle  
5 1/2" L x 3 1/2" H  
(14 x 8.9 cm)
- CMP520** Oval  
5" L x 2 3/8" H  
(12.7 x 6 cm)
- CMP425** Rectangle  
3 3/4" L x 2 1/2" H  
(9.5 x 6.4 cm)

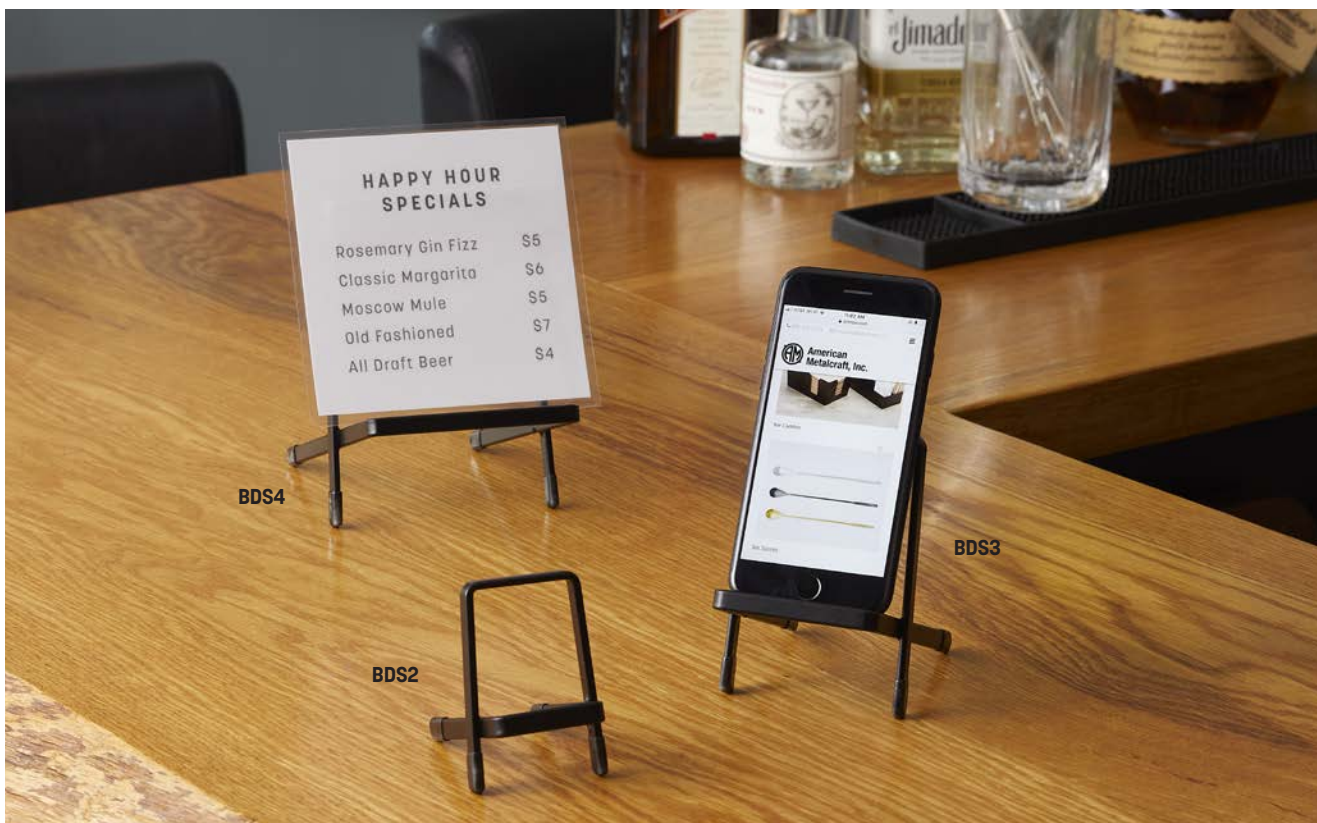

### Black Display Stands

Display promotional messages, QR menu codes, or provide a safe stand for cell phones with these versatile black display stands. Available in multiple sizes for individual needs.

- BDS2** 2" L x 3 3/8" W x 3 1/4" H  
(5.1 x 8.6 x 8.3 cm)
- BDS3** 3" L x 5" W x 4 1/2" H  
(7.6 x 12.7 x 11.4 cm)
- BDS4** 4 1/8" L x 6" W x 5 3/4" H  
(10.5 x 15.2 x 14.6 cm)

### Mini Chalk Cards

These mini blackboards fit into holders, clips and number stands. Each pack comes with its own White Securit Chalk Marker, four mini chalk card picks and two acrylic mini chalk card holders. **Sold in a pack of 20.**

- TAGA8WT** 3" L x 2" H (7.6 x 5.1 cm)
- TAGA7WT** 4" L x 3" H (10.2 x 7.6 cm)
- TAGA6WT** 6" L x 4" H (15.2 x 10.2 cm)



**TAGA6WT** shown with MCHW125 card holder

**TAGA8WT** shown with MCHB125 card holder

**TAGA7WT** shown with MCHB125 card holder

COMES WITH WHITE SECURIT MARKER THAT MAKES LABELING A CINCH





### Tabletop Boards

Create custom messages and designs with these double-sided boards in your choice of size and finish. Removable, reusable blackboard included. Markers sold separately on pg. 321.

- ELEBSM** 4" W x 6" H  
(10.2 x 15.2 cm)
- ELEBME** 6" W x 9" H  
(15.2 x 22.9 cm)
- ELEBLA** 9" W x 12" H  
(22.9 x 30.5 cm)

### Tabletop Chalkboards

These stand-alone, one-piece boards are a modern way to elevate buffets, breakfast bars and display cases.

- TBABLA8** 2 7/8" L x 7/8" W x 2" H  
(7.3 x 2.2 x 5.1 cm)  
**Pack of 5**
- TBABLA7** 2 7/8" L x 1 3/8" W x 4 1/8" H  
(7.3 x 3.5 x 10.5 cm)  
**Pack of 5**
- TBABLA6** 4 1/8" L x 1 3/4" W x 5 7/8" H  
(10.5 x 4.4 x 14.9 cm)  
**Pack of 3**
- TBABLA5** 5 7/8" L x 3" W x 8 1/4" H  
(14.9 x 7.6 x 21 cm)  
**Pack of 3**



### Mini Tabletop Sandwich Board

There are few more iconic forms of restaurant signage than the sandwich board. This tabletop mini sandwich board takes that classic look and brings it up-to-date, playfully announcing daily specials, drink deals and menu updates directly at the table where guests can't miss them.

- SBSBMNI** Plain, 6" W x 9 3/4" H  
(15.2 x 24.8 cm)

### Stencil Set

With these transparent stencil letters, numbers and symbols, anyone can make impressively professional signage.

- SECSTN5** Stencil Set  
9" L x 13" W (22.9 x 33 cm)



SBSBMNI



SECSTN5

# Securit®



## Mini Tip



FROM LEFT TO RIGHT  
 WHITE  
 BLUE  
 GREEN  
 RED  
 NEON YELLOW  
 NEON PINK  
 NEON ORANGE  
 NEON PURPLE



SMA100WT



BLSMA100V4WH



BLSMA100V4CO



BLSMA100V4TR



## Small Tip



FROM LEFT TO RIGHT:  
 WHITE  
 BLUE  
 GREEN  
 RED  
 YELLOW  
 SLATE GRAY  
 FORGET-ME-NOT  
 MOSS GREEN  
 BUTTERCUP  
 GOLDEN YARROW  
 HONEYSUCKLE  
 JUBILEE CHERRY  
 BURNT SIENNA



SMA510WT



BLSMA510WT



SMA510V4WT



SMA510V4



SMA510V8ET

## Original Chalk Markers

Great signage takes a bit of artistry, but just using a better medium will bring out your most inspired menus and promotions. These chalk markers are resistant to smudging, fading and light rain. Plus, they can be used on any non-porous surfaces and easily cleaned off with a soapy wet cloth.

## Mini Tip Markers

SMA100WT White Mini Tip Bulk Pack



BLSMA100V4WH White Mini Tip Blister 4-Pack



BLSMA100V4CO Assortment Mini Tip Blister 4-Pack (White, Blue, Green, Red)



BLSMA100V4TR Assortment Tropical Mini Tip Blister 4-Pack (Neon Purple, Neon Yellow, Neon Pink, Neon Orange)



## Small Tip Markers

SMA510WT White Small Tip Bulk Pack



BLSMA510WT White Small Tip Blister 2-Pack



SMA510V4WT White Small Tip 4-Pack



SMA510V4 Assortment Small Tip 4-Pack (Green, Yellow, Blue, Red)



SECSTN5 Earth Tone Assortment Small Tip 8-pack (Slate Gray, Forget-Me-Not, Moss Green, Buttercup, Golden Yarrow, Honeysuckle, Jubilee Cherry, Burnt Sienna)







## Wood Menu Holders

These versatile clipboards and rubberband boards can be used for full-service menus, bar service and check presentation. In your choice of style, color and size.

### Bamboo Clipboards

- BB8** 4" W x 8" H (10.2 x 20.3 cm)
- BB4** 4 ½" W x 12 ½" H (11.4 x 31.8 cm)
- BB12** 9" W x 12 ½" H (22.9 x 31.8 cm)
- BB15** 9" W x 15 ½" H (22.9 x 39.4 cm)

### Bamboo Rubberband Boards

- BBR12** 4 ½" W x 12 ½" H (11.4 x 31.8 cm)
- BBRB** 9" W x 12 ½" H (22.9 x 31.8 cm)
- BBR15** 9" W x 15 ½" H (22.9 x 39.4 cm)

### Espresso Clipboards

- CB8** 4" W x 8" H (10.2 x 20.3 cm)
- CB4** 4 ½" W x 12 ½" H (11.4 x 31.8 cm)
- CB12** 9" W x 12 ½" H (22.9 x 31.8 cm)
- CB15** 9" W x 15 ½" H (22.9 x 39.4 cm)

### Espresso Rubberband Boards

- CBRB12** 4 ½" W x 12 ½" H (11.4 x 31.8 cm)
- CBRB** 9" W x 12 ½" H (22.9 x 31.8 cm)
- CBR15** 9" W x 15 ½" H (22.9 x 39.4 cm)



### Classic Menu Holder and Bill Presenter

For more classical presentation, these holders feature a faux leather finish with gold lettering or design, gold corner reinforcements, an elastic cord and a two-page plastic insert.

**MCCRLSBL** Black Menu Holder  
10" W x 13" H (25.4 x 33 cm)

**MCCRBPBL** Black Bill Presenter with Cash and Credit Card Sleeves  
5" W x 9" H (12.7 x 22.9 cm)

MCCRLSBL

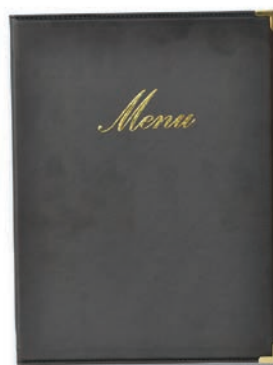

MCCRBPBL

### Trendy Menu Holder and Bill Presenter

Details like a faux leather finish, double-sided stitching, debossed lettering, an elastic cord inside the spine and a two-page plastic insert make these a fantastic contemporary alternative to the traditional menu.

**MCTRLSBL** Black Menu Holder  
10" W x 13" H (25.4 x 33 cm)

**MCTRPBPL** Black Bill Presenter with Cash and Credit Card Sleeve  
5" W x 9" H (12.7 x 22.9 cm)

WITH STYLISH DOUBLE-SIDED STITCHING

MCTRPBPL



MCTRLSBL

### Bill Presenter Treasure Box

The perfect way to end the meal! This Treasure Box can present bills, teas, even after-dinner treats.

**MCBPBOXAN** 6" L x 4" W x 4 1/4" H  
(15.2 x 10.2 x 10.8 cm)



MCBPBOXAN



### Bamboo Block Check Presenter

Your customers will remember this compact, ultra-contemporary way to pay.

**WBB** 3 1/2" L x 2 3/4" W x 3 1/4" H  
(8.9 x 7 x 8.3 cm)



WBB

### Stainless Steel Bill Presenter

**MCBPBSS** 7 1/4" L x 3 5/8" W x 1/2" H  
(18.4 x 9.2 x 1.3 cm)

### Black Bill Presenter

This simple PVC presenter features two-page clear plastic sleeves and a credit card sleeve.

**MCBRBPBL** 5" W x 9 3/8" H  
(12.7 x 23.8 cm)



MCBPBSS



**HOT**

MCBRBPBL



EASY TO CLEAN AND  
UPDATE ON THE FLY

HOT



WBWBL4060



WBWBL6080

## Wall Boards HOT

Natural black wood frames turn up the professionalism on these scratch-resistant boards. White Securit Chalk Marker, wall-mounting wire and hooks included.

**WBWBL4060** 15 3/4" W x 23 5/8" H (40 x 60 cm)

**WBWBL6080** 31 1/2" W x 23 5/8" H (80 X 60 cm)

## Deluxe Sandwich Boards HOT

The double-sided design and vibrant finishes on these premium sandwich boards make them ideal for catching eyes in high-traffic areas. Featuring robust, UV-resistant Securit writing surfaces that are suitable for all weather conditions.

### Mahogany

**SBDM85** 21 1/2" L x 2 1/4" W x 33 1/2" H  
(54.6 x 5.7 x 85.1 cm)  
(not shown)

**SBSM135** 28 1/8" L x 2 3/8" W x 54 3/4" H  
(71.4 x 6 x 139.1 cm)

### Plain

**SBDB85** 21 1/2" L x 2 1/4" W x 33 1/2" H  
(54.6 x 5.7 x 85.1 cm)  
(not shown)

**SBSB135** 28 1/8" L x 2 3/8" W x 54 3/4" H  
(71.4 x 6 x 139.1 cm)



SBSM135



SBSB135

## Sandwich Boards HOT

These simple, smartly-priced sandwich boards don't skimp on quality. Featuring natural black wood frames and scratch-resistant writing surfaces.

**SBDBL85** 21 1/2" L x 2 1/4" W x 33 1/2" H  
(54.6 x 5.7 x 85.1 cm)

**SBSBL120** 27 1/4" L x 4" W x 49 1/4" H  
(69.2 x 10.2 x 125.1 cm)  
(not shown)



SBDBL85



SPRV1



SPRV2

### Free-Standing Smoker Poles

Maintain a comfortable space for all customers with this modern, inconspicuous cigarette disposal. Featuring screw-off top (on free-standing pole) or bottom (on wall-mounted pole) for quick emptying. Intended for outdoor use only.

**SPRV1**     Brushed Stainless Steel  
Free-Standing Smoker Pole & Base  
9 3/4" Dia. x 40" H (24.8 x 101.6 cm)

**SPRV2**     Black  
Free-Standing Smoker Pole & Base  
9 3/4" Dia. x 40" H (24.8 x 101.6 cm)

### Wall-Mounted Smoker Pole

**SPSSWM2**     Brushed Stainless Steel  
Wall-Mounted Smoker Pole  
2 1/2" Dia. x 22" H (6.4 x 55.9 cm)



SPSSWM2

BOTTOM SCREWS  
OFF FOR EASY  
EMPTYING





**RBSS**  
(one set shown)

**Value-Priced Barrier Systems** 

The ideal way to control a crowd and ensure social distancing measures are clearly displayed. With a low price tag and sleek, modern design, these sets are the perfect social distancing solution. Set includes two poles, two bases and black nylon tape. Signs sold separately.

**RBSS** 84" Tape x 35 1/4" H Posts  
(213.4 x 89.5 cm)  
12 1/2" (31.8 cm) Dia. Bases

**RBSBL** 84" Tape x 35 1/4" H Posts  
(213.4 x 89.5 cm)  
12 1/2" (31.8 cm) Dia. Bases

NEW VALUE-PRICED SETS



**RBSBL**  
(one set shown)



USE WITH CORRESPONDING  
VALUE-PRICED BARRIER  
SYSTEM SIGNS TO DISPLAY  
KEY INFORMATION



RBSIGNBL shown with RBSBL barrier system

### Value-Priced Barrier System Signs

Display important social distancing instructions with this two-sided, stainless steel sign. Simply slide it over the top of the post for instant customer communication.

#### Satin

**RBSIGNS** Vertical, Fits RBSS  
8 ½" W x 11" H  
(21.6 x 27.9 cm)

**RBHSIGNS** Horizontal, Fits RBSS  
11" W x 8 ½" H  
(27.9 x 21.6 cm)

#### Black

**RBSIGNBL** Vertical, Fits RBSBL  
8 ½" W x 11" H  
(21.6 x 27.9 cm)

**RBHSIGNBL** Horizontal, Fits RBSBL  
11" W x 8 ½" H  
(27.9 x 21.6 cm)



RBSIGNS



RBHSIGNS



RBSIGNBL



RBHSIGNBL





**RSRTRD**  
(four sets shown)

USABLE INDOOR OR OUTDOOR



**RSRTGY**  
(two sets shown)

**RSRTBK**  
(two sets shown)



**RSBPBL** (two sets shown)

ALL BARRIER SYSTEMS ARE FOR BOTH INDOOR AND OUTDOOR USE

## Retractable Barrier Systems

This versatile set extends your choice of nylon tape up to 84" (213.4 cm). Resilient nylon allows you to control the flow of customers in al fresco settings too. Set includes one post, nylon tape and one base.

### Red Tape

**RSRTRD** Brushed Stainless Steel Post & Base  
Red Nylon Tape  
84" Tape x 40" H Post (213.4 x 101.6 cm)  
15" (38.1 cm) Dia. Base

**RSRTRVSRDC1** Replacement Post for RSRTRD

### Gray Tape

**RSRTGY** Brushed Stainless Steel Post & Base  
Gray Nylon Tape  
84" Tape x 40" H Post (213.4 x 101.6 cm)  
15" (38.1 cm) Dia. Base

**RSRTRVSGYC2** Replacement Post for RSRTGY

### Black Tape

**RSRTBK** Brushed Stainless Steel Post & Base  
Black Nylon Tape  
84" Tape x 40" H Post (213.4 x 101.6 cm)  
15" (38.1 cm) Dia. Base

**RSRTRVSBLC4** Replacement Post for RSRTBK

### Replacement Parts

**RSRTRVSC3** Replacement Base

## Black Retractable Barrier System

Our classic barrier system, now available in sleek black-on-black styling. Extends up to 84" (213.4 cm). For indoor and outdoor use. Set includes one post, nylon tape and one base.

**RSBPBL** Black Matte Post & Base  
Black Nylon Tape  
84" Tape x 40" H Post  
(213.4 x 101.6 cm)  
15" (38.1 cm) Dia. Base

**RSRTBLC8** Replacement Post

**RSRTBLC9** Replacement Base

## Retractable Barrier System Set

**RSRTLWCH** (2) Brushed Stainless Steel Posts & Bases  
Black Nylon Tape  
84" Tape x 37" H Posts (213.4 x 93 cm)  
13" (33 cm) Dia. Bases



**RSRTLWCH**  
(one set shown)



**RSSIGNBLK** shown with RSBPBL barrier system



**RSSIGNLSPS** shown with RSRTBK barrier system

### Retractable Barrier System Signs

Popular demand has prompted us to add these two-sided signs designed to be mounted on all Securit retractable barriers. Simply slide the sign over the top of the post for instant customer communication. Available in a satin and black finish, horizontal and vertical orientations.

#### Satin

**RSSIGNLSPS** Vertical, Fits RSRTRD, RSRTGY, RSRTBK and RSRTLWCH  
8 ½" W x 11" H (21.6 x 27.9 cm)

**RHSSIGNLSPS** Horizontal, Fits RSRTRD, RSRTGY, RSRTBK and RSRTLWCH  
11 ½" W x 8 ½" H (29.2 x 21.6 cm)

#### Black

**RSSIGNBLK** Vertical, Fits RSBPBL  
8 ½" W x 11" H (21.6 x 27.9 cm)

**RHSSIGNBLK** Horizontal, Fits RSBPBL  
11 ½" W x 8 ½" H (29.2 x 21.6 cm)



**RHSSIGNBLK**



**RHSSIGNLSPS**

### Sign Sets

Communicating to guests just got easier. We have taken the four most common statements and applied them to sleek black signage, perfect for any barrier sign. Sign set includes: Please Wait to be Seated, Please Enter Here, Section Closed and Carry-Out Pickup.

**RBHMSG** Horizontal Pack  
10 ¾" W x 8" H (27.3 x 20.3 cm)

**RBVMSG** Vertical Sign Pack  
8" W x 10 ¾" H (20.3 x 27.3 cm)



**RBVMSG**



**RBHMSG**





RSCLG



RSCLC

### Deluxe Rope Barrier Systems

Finished with gold or silver to give your customers the Hollywood treatment. Set includes one post and one base.

#### Gold

**RSCLG** Classic Barrier  
Gold-Plated Post & Base  
15" Dia. x 40" H (38.1 x 101.6 cm)

**RSCLGOA1** Replacement Post

**RSCLGOA2** Replacement Base

#### Silver

**RSCLC** Classic Barrier Polished Chrome  
Flat Head Post & Base  
15" Dia. x 40" H (38.1 x 101.6 cm)

**RSCLCHB1** Replacement Post

**RSCLCHB2** Replacement Base

### Rope Barrier System Set

Crafted from mirror-polished, high-grade stainless steel and featuring an anti-scratch base. Ropes sold separately.

**RSLWCH** (2) Bases and (2) Posts  
12 1/2" Dia. x 37 1/4" H  
(31.8 x 94.6 cm)

### Barrier System Braided Ropes

2" (5.1 cm) thick and 60" (5.1 x 152.4 cm) long, in an elegant braided style with your choice of metal finish. For both indoor and outdoor use.

**RSCLRPGOBL** Black - Gold Ends

**RSCLRPCHBL** Black - Chrome Ends



RSCLRPGOBL

RSCLRPCHBL



RSLWCH

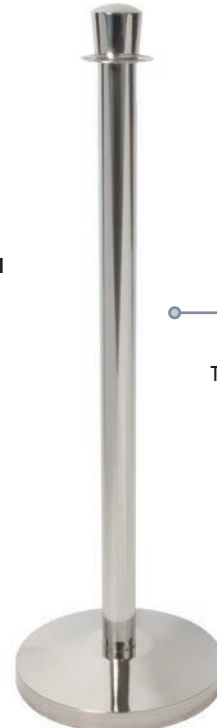

SET INCLUDES  
TWO POSTS AND  
TWO BASES

# Bar Supplies







**NEW**

**BCH18ST**

STACKABLE DESIGN

**BCR9ST**

**BCR15ST**



**NEW**

**BCR9ST**

PERFECT FOR OUTDOOR DINING DUE TO DURABLE AND LIGHTWEIGHT DESIGN

**DRINKWARE**

Poolside dining. Outdoor patios. Rooftop Bars. Today's hottest dining trends call for durable drinkware that can withstand the rigors of an outside environment. Made of BPA-free Tritan™ copolyester, rest assured that our drinkware is lightweight, strong, stain-resistant and commercial dishwasher safe. The look of glass with the durability of plastic.

**Crave Storm Collection** **NEW** **BPA FREE**

Finish the look with beautiful, organically textured Tritan glasses from the Crave Storm Collection. Each tumbler gives the look of handmade glass with the durability of a shatter-resistant, dishwasher-safe Tritan copolyester construction.

- BCR9ST** Stackable Rocks  
9 oz. (266.2 mL)  
3 1/8" Dia. x 4 1/4" H (7.9 x 10.8 cm)
- BCR15ST** Stackable Double Old Fashioned  
15 oz. (443.6 mL)  
3 5/8" Dia. x 4 5/8" H (9.2 x 11.7 cm)
- BCH18ST** Stackable Highball  
18 oz. (532.3 mL)  
3 1/2" Dia. x 6 1/4" H (8.9 x 15.9 cm)



### The Parker Collection BPA FREE

With the look of crystal but the durability of plastic, the Parker Collection's elegant sophistication will certainly turn heads. Made of Tritan copolyester, a shatter-resistant, ultra-strong, dishwasher-safe material.

- BPF8** Stemless Champagne Flute  
9 oz. (266.2 mL)  
2 3/8" Dia. x 5 1/2" H (6 x 14 cm)
- BPW13** Stemmed Wine/Drink Glass  
13 oz. (384.5 mL)  
4 1/8" Dia. x 8" H (10.5 x 20.3 cm)
- BPSW15** Stemless Wine Glass  
15 oz. (443.6 mL)  
3 1/2" Dia. x 4 1/2" H (8.9 x 11.4 cm)
- BPSW20** Stemless Wine Glass  
20 oz. (591.5 mL)  
3 3/4" Dia. x 5" H (9.5 x 12.7 cm)
- BPCL72** Carafe with Lid  
72 oz. (2.1 L)  
5" Dia. x 11" H (12.7 x 27.9 cm)
- BPWC7** Wine Bucket  
7" Dia. x 7 3/4" H (17.8 x 19.7 cm)
- BPD13** Double Old Fashioned  
13 oz. (384.5 mL)  
3 5/8" Dia. x 4 3/8" H (9.2 x 11.1 cm)
- BPH21** Highball  
21 oz. (621 mL)  
3 1/2" Dia. x 6 3/4" H (8.9 x 17.1 cm)





HOT



BLH19

BLS14

BLR14

STACKABLE DESIGN



BHH19

BHR14

### Lilli Collection HOT BPA FREE

Our Lilli Collection features a fresh embossed design that provides a nostalgic feel. Made with BPA-free Tritan copolyester, these glasses have the delicate look of glass with the durability of plastic.

- BLR14** Double Old Fashioned  
14 oz. (414 mL)  
3 1/4" Dia. x 4 1/2" H (8.3 x 11.4 cm)
- BLS14** Stackable Double Old Fashioned  
14 oz. (414 mL)  
3 3/8" Dia. x 4 1/2" H (8.6 x 11.4 cm)
- BLH19** Highball  
19 oz. (561.9 mL)  
3 3/8" Dia. x 6 1/4" H (8.6 x 15.9 cm)

### Hadley Collection BPA FREE

Old-fashioned charm meets current fashion with the Hadley Collection. Featuring a cut crystal look, this line exudes pure elegance. Ideal for outdoor bars and lounges.

- BHR14** Double Old Fashioned  
14 oz. (414 mL)  
3 3/8" Dia. x 4 1/2" H (8.6 x 11.4 cm)
- BHH19** Highball  
19 oz. (561.9 mL)  
3 3/8" Dia. x 6 1/4" H (8.6 x 15.9 cm)

Shown with WBC36 water bottle



BSH20

BSR14

**Sanibel Collection** BPA FREE

A classic everyday look, the Sanibel Collection features a weighted base and cut crystal design. A perfect choice for ice cold water, cocktails or soft drinks, this line of clear, resilient Tritan drinkware provides a refreshing twist on a hot summer day.

**BSR14** Double Old Fashioned  
14 oz. (354.9 mL)  
3 3/8" Dia. x 3 3/4" H (8.6 x 9.5 cm)

**BSH20** Highball  
20 oz. (591.5 mL)  
3 1/8" Dia. x 6 1/8" H (7.9 x 15.6 cm)

**Unity Collection** BPA FREE

With a heavy base and slight taper, this crystal-clear Tritan line of glasses complements our Unity dinnerware collection entirely. This line is versatile for everyday use but also provides an upscale look.

**BUR15** Double Old Fashioned  
15 oz. (443.6 mL)  
3" Dia. x 4 3/8" H (7.6 x 11.1 cm)

**BUH18** Highball  
18 oz. (532.3 mL)  
2 3/4" Dia. x 6 1/4" H (7 x 15.9 cm)



BUH18

BUR15





OUR BIGGEST MUG MEASURES IN AT AROUND A GALLON AND A HALF (YES, REALLY) TO QUENCH EVEN THE THIRSTIEST CROWDS

CM96H

CM192H

Shown with  
AWB12 rimmed oval ashwood serving board,  
MDLR10 stainless steel muddler and  
CM16H Moscow mule mug

## MOSCOW MULE MUGS

In a range of sizes and finishes, our trendy Moscow Mule Mugs can accommodate individual drinks or shareable cocktails. Or, for an outside-the-box conversation piece, load them up with food.

### Jumbo Hammered Copper Moscow Mule Mugs

**CM96H** 96 oz. (2.8 L)  
6" Dia. x 6 5/8" H  
8" W with Handle  
(15.2 x 16.8, 20.3 cm)

**CM192H** 192 oz. (5.7 L)  
7 1/2" Dia. x 8 1/8" H  
9 1/2" W with Handle  
(19.1 x 20.6, 24.1 cm)

**Moscow Mule Mugs** HOT

**Copper/Brass**

- CM16H** Hammered Finish  
16 oz. (473.2 mL)  
3 3/4" Dia. x 4 3/4" H  
4 3/4" W with Handle  
(9.5 x 12.1, 12.1 cm)
- CM16P** Mirror Finish  
16 oz. (473.2 mL)  
3 3/4" Dia. x 4 3/4" H  
4 3/4" W with Handle  
(9.5 x 12.1, 12.1 cm)

**Gold/Brass**

- GM16H** Hammered Finish  
16 oz. (473.2 mL)  
3 3/4" Dia. x 4 3/4" H  
4 3/4" W with Handle  
(9.5 x 12.1, 12.1 cm)
- GM16P** Mirror Finish  
16 oz. (473.2 mL)  
3 3/4" Dia. x 4 3/4" H  
4 3/4" W with Handle  
(9.5 x 12.1, 12.1 cm)

**Black/Brass**

- BM16H** Hammered Finish  
16 oz. (473.2 mL)  
3 3/4" Dia. x 4 3/4" H  
4 3/4" W with Handle  
(9.5 x 12.1, 12.1 cm)
- BM16P** Mirror Finish  
16 oz. (473.2 mL)  
3 3/4" Dia. x 4 3/4" H  
4 3/4" W with Handle  
(9.5 x 12.1, 12.1 cm)







## THE ANTIQUE COPPER COLLECTION

Natural elements and minerals are on-trend. So it just made sense to add all of these copper mugs, tumblers, cocktail shakers and bar accessories to our line. Mix, stir, shake and toast... Here's to you.

### Antique Copper Moscow Mule Tumblers

- ACT** Satin Finish  
14 oz. (414 mL)  
2 3/4" Dia. x 3 1/2" H (7 x 8.9 cm)
- ACTH** Hammered Finish  
14 oz. (414 mL)  
2 3/4" Dia. x 3 1/2" H (7 x 8.9 cm)

### Antique Copper Moscow Mule Mugs

- ACM** Satin Finish  
14 oz. (414 mL)  
2 3/4" Dia. x 3 1/2" H, 3 7/8" W with Handle  
(7 x 8.9, 9.8 cm)
- ACMH** Hammered Finish  
14 oz. (414 mL)  
2 3/4" Dia. x 3 1/2" H, 3 7/8" W with Handle  
(7 x 8.9, 9.8 cm)

### Antique Copper Cups

- ACC** Satin Finish  
14 oz. (414 mL)  
3 1/8" Dia. x 3 1/2" H (7.9 x 8.9 cm)
- ACCH** Hammered Finish  
14 oz. (414 mL)  
3 1/8" Dia. x 3 1/2" H (7.9 x 8.9 cm)



### Martini Glass Servers

Use these stainless steel martini glasses for their obvious purpose or for serving snacks, appetizers and other finger foods.

**MART1** 10 oz. (295.7 mL)  
5 7/8" Dia. x 8 1/4" H x 2 1/2" Deep  
(14.9 x 21 x 6.4 cm)

**JMART15** 80 oz. (2.4 L)  
9" Dia. x 15" H x 5 1/4" Deep  
(22.9 x 38.1 x 13.3 cm)

### Double-Wall Martini Glasses

In a satin or hammered stainless steel design, these glasses perform double duty for beverages or bar snacks.

**DWC7** Satin Finish  
7 oz. (207 mL)  
4 1/2" Dia. x 3 3/4" H  
(11.4 x 9.5 cm)

**DWCH7** Hammered Finish  
7 oz. (207 mL)  
4 1/2" Dia. x 3 3/4" H  
(11.4 x 9.5 cm)







## Hammered Double-Wall Collins Glasses

Mix and serve over ice with these double-wall hammered Collins glasses. Available in durable stainless steel and in a variety of popular colors, each glass is designed to keep cocktails ultra-chilled without outer condensation. The experience is purely enjoyable.

**HMCC14** Copper  
14 oz. (414 mL)  
2 5/8" Dia. x 6" H  
(6.7 x 15.2 cm)

**HMCB14** Black  
14 oz. (414 mL)  
2 5/8" Dia. x 6" H  
(6.7 x 15.2 cm)

**HMCS14** Silver  
14 oz. (414 mL)  
2 5/8" Dia. x 6" H  
(6.7 x 15.2 cm)

## Moroccan Tumbler

Whether you use this tumbler for creative beverage service or even more imaginative food presentation, it delivers a handcrafted aesthetic. Made of stainless steel.

**HV3** Silver  
12 oz. (354.9 mL)  
3 1/4" Dia. x 4 1/4" H  
(8.3 x 10.8 cm)



HV3

Shown with  
FSLT10 faux slate  
melamine platter

GREAT FOR FOOD OR DRINK

## Hammered Double-Wall Cups and Tumblers

Make a splash at the bar with these hammered, mirrored-finish stainless steel designs in three different colors.

### Copper

**HMTC14** Mule Cup  
14 oz. (414 mL)  
3 1/2" Dia. x 4 1/2" H  
(8.9 x 11.4 cm)

**HMTC16** Tumbler  
16 oz. (473.2 mL)  
3 1/2" Dia. x 5 3/4" H  
(8.9 x 14.6 cm)

### Silver

**HMTS14** Mule Cup  
14 oz. (414 mL)  
3 1/2" Dia. x 4 1/2" H  
(8.9 x 11.4 cm)

**HMTS16** Tumbler  
16 oz. (473.2 mL)  
3 1/2" Dia. x 5 3/4" H  
(8.9 x 14.6 cm)

### Black

**HMTB14** Mule Cup  
14 oz. (414 mL)  
3 1/2" Dia. x 4 1/2" H  
(8.9 x 11.4 cm)

**HMTB16** Tumbler  
16 oz. (473.2 mL)  
3 1/2" Dia. x 5 3/4" H  
(8.9 x 14.6 cm)





CREATIVE COCKTAILS CALL FOR CREATIVE CUPS, AND WE HAVE ONE FOR EVERY OCCASION



Shown with SST14 Royal Touch serving tray

### Alternative Drinking Vessels

Mix up cups, bottles and jars to achieve creative, interesting service for beverages of all types.

- MJ17** Mason Jar  
17 oz. (502.8 mL)  
3" Dia. x 5 3/8" H (7.6 x 13.7 cm)
- GMB8** Glass Milk Bottle  
8 oz. (236.6 mL)  
2 1/4" Dia. x 5 1/2" H (5.7 x 14 cm)
- JC11** Mint Julep Cup  
11 oz. (325.3 mL)  
3" Dia. x 4 1/4" H (8.3 x 10.8 cm)
- HV3** Moroccan Tumbler  
12 oz. (354.9 mL)  
3 1/4" Dia. x 4 1/4" H (8.3 x 10.8 cm)
- MICH15** Stainless Steel Milk Can  
15 oz. (443.6 mL)  
2 3/4" Dia. x 5" H (7 x 12.7 cm)
- GMB16** Glass Milk Bottle  
16 oz. (473.2 mL)  
2 3/4" Dia. x 6 1/2" H (7 x 16.5 cm)
- GJ8** Square Glass Jar  
8 oz. (236.6 mL)  
3" Sq. x 3" H (7.6 x 7.6 cm)
- MJ85** Mason Jar  
8 1/2 oz. (250 mL)  
3" Dia. x 3 1/2" H (7.6 x 8.9 cm)



### Classic Mint Julep Cups

Featuring elegant beading and a mirrored finish, these stunning cups will have your mint julep presentation off to the races.

- JC12** 12 oz. (354.9 mL)  
3 3/8" Dia. x 4 1/2" H (8.6 x 11.4 cm)
- JC16** 16 oz. (473.2 mL)  
3 5/8" Dia. x 5 3/4" H (9.2 x 14.6 cm)

### Mint Julep Cups

Make every day Derby Day with these sleek Mint Julep Cups crafted from brushed stainless steel.

- JC8** 8 oz. (236.6 mL)  
2 7/8" Dia. x 3 7/8" H (7.4 x 9.8 cm)
- JC11** 11 oz. (325.3 mL)  
3" Dia. x 4 1/4" H (7.6 x 10.8 cm)
- JC14** 14 oz. (414 mL)  
3 1/4" Dia. x 4 5/8" H (8.3 x 11.8 cm)

## Carbonized Bamboo Flight Boards

The rich color of these flight boards brings out the best in brews and bites alike.

**BWF4** Flight Board  
 13 7/8" L x 3 3/8" W x 1 1/4" H  
 (35.2 x 8.6 x 3.2 cm)

**BWF3** Pairing Flight Board  
 13 7/8" L x 6 7/8" W x 1 1/4" H  
 (35.2 x 17.5 x 3.2 cm)





Shown with BHR14 drinkware and BSS12 bar spoon



Shown with MSTNG5 tongs

## COCKTAIL PREP

With the cocktail craze in full swing, it's not enough to make great drinks. You have to look good doing it. As mixology methods become more refined, bartending experts look to step up their game with accessories that match their liquid assets. These pieces raise the bar for preparation and presentation.

### Cocktail Mixing Tins

Mix up ice cold cocktails with a modern twist with these stainless steel mixing tins. Featuring a contemporary satin-finished design, each drink will pour with ease from the precision spout. Durable and dishwasher safe.

- MTS20** 20 oz. (591.5 mL)  
3 3/8" Dia. x 4 1/4" H (8.6 x 10.8 cm)
- MTS26** 26 oz. (768.9 mL)  
3 1/2" Dia. x 5" H (8.9 x 12.7 cm)
- MTS32** 32 oz. (946.4 mL)  
4" Dia. x 5 1/2" H (10.2 x 14 cm)

### Cocktail Mixing Glasses

In 20, 25 and 30 oz. capacities, this barware is available in stemmed, clear, diamond and hand-cut glass designs.

#### Clear

**MGC20** 20 oz. (591.5 mL)  
3 1/2" Dia. x 5 1/4" H (8.9 x 13.3 cm)

**MGC25** 25 oz. (739.3 mL)  
3 1/2" Dia. x 6 1/2" H (8.9 x 16.5 cm)

#### Diamond

**MGD20** 20 oz. (591.5 mL)  
3 1/2" Dia. x 5 1/4" H (8.9 x 13.3 cm)

**MGD25** 25 oz. (739.3 mL)  
3 1/2" Dia. x 6 1/2" H (8.9 x 16.5 cm)

#### Hand-Cut

**MGL20** 20 oz. (591.5 mL)  
3 1/2" Dia. x 5 1/4" H (8.9 x 13.3 cm)

**MGL25** 25 oz. (739.3 mL)  
3 1/2" Dia. x 6 1/2" H (8.9 x 16.5 cm)



### Glass Bitters Bottles

Choose from three different designs that include a stainless steel and silicone stopper.

**BB2** Clear  
4 oz. (118.3 mL)  
2 1/2" Dia. x 5 1/2" H (6.4 x 14 cm)

**BBC2** Diamond  
4 oz. (118.3 mL)  
2 1/2" Dia. x 5 1/2" H (6.4 x 14 cm)

**BBRC** Replacement Stainless Steel and Silicone Dasher (not shown)  
1" Dia. x 2 1/2" H (2.5 x 6.3 cm)





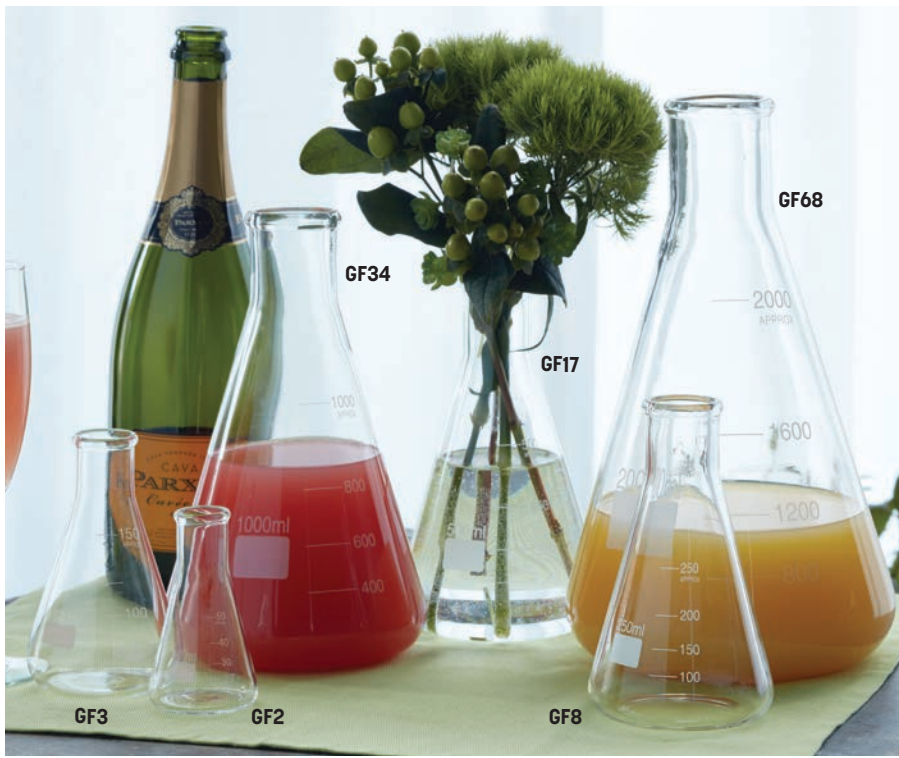

## THE CHEMISTRY COLLECTION

Create your most inspired concoctions with these flasks and beakers that make even classic cocktails feel experimental. Capacity markings make measuring easy.

### Glass Chemistry Flasks

- GF2** 1 ¾ oz. (50 mL)  
2" Dia. x 3 ¾" H (5.1 x 9.5 cm)
- GF3** 5 oz. (150 mL)  
3" Dia. x 4 ¾" H (7.6 x 12.1 cm)
- GF8** 8 ½ oz. (250 mL)  
3 ½" Dia. x 5 ¾" H (8.9 x 14.6 cm)
- GF17** 17 oz. (500 mL)  
4" Dia. x 7" H (10.2 x 17.8 cm)
- GF34** 34 oz. (1000 mL)  
5" Dia. x 8 ¾" H (12.7 x 22.2 cm)
- GF68** 68 oz. (2000 mL)  
6 ½" Dia. x 11" H (16.5 x 27.9 cm)

### Glass Chemistry Beakers

- GBE2** 1 ¾ oz. (50 mL)  
1 ¾" Dia. x 2 ¼" H (4.5 x 5.7 cm)
- GBE3** 3 ½ oz. (100 mL)  
2 ½" Dia. x 3" H (6.4 x 7.6 cm)
- GBE8** 8 ½ oz. (250 mL)  
3" Dia. x 4" H (7.6 x 10.2 cm)
- GBE17** 17 oz. (500 mL)  
3 ¼" Dia. x 5" H (8.3 x 12.7 cm)
- GBE34** 34 oz. (1000 mL)  
4 ¼" Dia. x 5 ¼" H (10.8 x 13.3 cm)
- GBE64** 64 oz. (2000 mL)  
5 ¼" Dia. x 7 ½" H (13.3 x 19.1 cm)



CAPACITIES ARE CLEARLY MARKED



### Glass Water Bottles and Stoppers

Mix and match two styles of carafes and three styles of stoppers to elevate your H<sub>2</sub>O. Bottles and stoppers sold separately.

#### Glass Water Bottles

- GCD28** Diamond  
29 oz., 28 oz. to Shoulder (0.9 L, 0.8 L)  
3 1/8" Dia. x 10 1/4" H (7.9 x 26 cm)
- GCH28** Pebbled  
29 oz., 28 oz. to Shoulder (0.9 L, 0.8 L)  
3 1/8" Dia. x 10 1/4" H (7.9 x 26 cm)

#### Glass and Silicone Bottle Stoppers

- GSB2** Blue Marble, 1 3/4" Dia. x 2 3/4" H (4.4 x 7 cm)
- GSC2** Clear, 1 3/4" Dia. x 2 3/4" H (4.4 x 7 cm)
- GSF2** Frosted, 1 3/4" Dia. x 2 3/4" H (4.4 x 7 cm)

### Glass Carafes

With smaller sizes for individual servings of beverages and larger sizes for shared drinks, these elegantly curved carafes are a stylish addition to any brunch or dinner service.

#### Multi-Serving

- GC36** 36 oz., 34 oz. to Shoulder (1.1 L, 1 L)  
4" Dia. x 9 1/2" H (10.2 x 24.1 cm)
- GC34** 34 oz., 16 oz. to Shoulder (1 L, 473.2 mL)  
4" Dia. x 9 1/2" H (10.2 x 24.1 cm)

#### Single-Serving

- GC12** 12 oz., 10.5 oz. to Shoulder (354.9 mL, 310.5 mL)  
3 1/4" Dia. x 4 3/4" H (8.2 x 12 cm)
- GC8** 8 oz., 3 oz. to Shoulder (236.6 mL, 88.7 mL)  
3" Dia. x 4 3/4" H (7.6 x 12 cm)









### Clear Acrylic Water Bottles

In a quartet of distinct styles, these one-liter acrylic bottles make even simple beverages photogenic. Cap included.

**WB32** Clear, 34 oz. (1 L)  
 3 1/2" Dia. x 11 1/4" H  
 (8.9 x 28.6 cm)

**WB33** Fluted, 34 oz. (1 L)  
 3 1/2" Dia. x 11 1/4" H  
 (8.9 x 28.6 cm)

**WB34** Pebbled, 34 oz. (1 L)  
 3 1/2" Dia. x 11 1/4" H  
 (8.9 x 28.6 cm)

**WB35** Diamond 34 oz. (1 L)  
 3 1/2" Dia. x 11 1/4" H  
 (8.9 x 28.6 cm)

**WBCAP** Replacement Cap  
 1" Dia. x 1" H  
 (2.5 x 2.5 cm)



### Stainless Steel Tapered Pourer

Turn one of our Clear Acrylic Water Bottles into a jumbo-sized mixer bottle with this pourer made from stainless steel and plastic cork. It's a memorable way to give your bar an extra splash of panache. **Sold in a pack of 12.**

**DPR1** Stainless Steel Pourer  
 Fits WB32, WB33, WB34, WB35  
 1 3/4" Dia. x 4 3/4" H  
 (4.4 x 12.1 cm)



### Hinged Acrylic Water Bottles

Our original take on a popular style, these gasketed bottles are designed to keep out contaminants.

**WBC34** Clear, 34 oz. (1 L)  
 4 1/8" Dia. x 11 5/8" H (10.5 x 29.5 cm)

**WBC36** Clear, 36 oz. (1.1 L)  
 3 3/8" Dia. x 11 1/8" H (8.6 x 28.3 cm)

### Pebbled Acrylic Water Bottle

Inspired by our pebbled glass water bottle, this piece is made from plastic for extra durability. Cap included.

**WBP34** Clear, 34 oz. (1 L)  
 3 7/8" Dia. x 11 5/8" H (8.9 x 29.5 cm)

**WBPCAP** Replacement Cap  
 2 1/4" Dia. x 5/8" H (5.7 x 1.6 cm)



### Cocktail Smoking Dome Cover

Smoking cocktails has never been easier with this crystal-clear polycarbonate dome cover. Complete with a silicone valve that accommodates most smoking guns, this durable dome is designed to keep smoke in while cocktails and other menu items get properly flavored.

**SLFTD8** 8 ¼" Dia. x 8 ½" H  
(21 x 21.6 cm)



SMOKING GUN  
SOLD SEPARATELY

SLFTD8

Shown with MWP9 plate and BHR14 drinkware

### Black Silicone Ice Molds

All are made of dishwasher-safe, BPA-free, food-safe silicone and withstand temperatures from -4° F (-20° C) to 392° F (200° C). Molds create perfectly round or square ice.

#### Sphere Molds

**SMSR4** (4) 2 ½" Dia. (6.4 cm)  
4 oz. (118.3 mL)  
6 ⅞" Sq. x 2 ½" H (15.6 x 6.4 cm)  
Tray with Lid

**SMSR8** (6) 1 ½" Dia. (3.8 cm)  
1 ¾ oz. (51.8 mL)  
7" L x 4 ⅝" W x 1 ½" H  
(17.8 x 11.7 x 3.8 cm)  
Tray with Lid



SMSR8

SMSR4

#### Cube Molds

**SMSC4** (4) 2" Sq. (5.1 cm)  
3 ½ oz. (103.5 mL)  
4 ½" Sq. x 2" H (11.4 x 5.1 cm)  
Tray with Lid

**SMSC8** (8) 2" Sq. (5.1 cm)  
3 ½ oz. (103.5 mL)  
8 ½" L x 4 ½" W x 2" H  
(21.6 x 11.4 x 5.1 cm)



SMSC4

SMSC8



**WARNING:** This product can expose you to chemicals including Bisphenol A (BPA), which is known to the State of California to cause birth defects or other reproductive harm. For more information, go to [www.P65warnings.ca.gov](http://www.P65warnings.ca.gov). Warning applies to State of California only.





BSSET

## Boston Shaker Sets

Chill it, shake it and serve it! These weighted satin-finish stainless steel tins fit firmly together to mix up your favorite cocktails. Available in a set or as individual sizes. Gold color may vary slightly.

### Silver

**BSSET** Set, 18 oz. (532.3 mL)  
 3 3/8" Dia. x 5 1/4" H (8.6 x 13.3 cm)  
 28 oz. (828.1 mL)  
 3 5/8" Dia. x 7" H (9.2 x 17.8 cm)

**BS18** Replacement Cup, 18 oz. (532.3 mL)  
 3 3/8" Dia. x 5 1/4" H (8.6 x 13.3 cm)

**BS28** Replacement Cup, 28 oz. (828.1 mL)  
 3 5/8" Dia. x 7" H (9.2 x 17.8 cm)

### Gold

**GBSSET** Set, 18 oz. (532.3 mL)  
 3 3/8" Dia. x 5 1/4" H (8.6 x 13.3 cm)  
 28 oz. (828.1 mL)  
 3 5/8" Dia. x 7" H (9.2 x 17.8 cm)

**GBS18** Replacement Cup, 18 oz. (532.3 mL)  
 3 3/8" Dia. x 5 1/4" H (8.6 x 13.3 cm)

**GBS28** Replacement Cup, 28 oz. (828.1 mL)  
 3 5/8" Dia. x 7" H (9.2 x 17.8 cm)



DISHWASHER-SAFE FINISH

GBSSET

NEW

## Antique Copper Cocktail Shakers

Part of our award-winning Antique Copper Collection, these cocktail shakers do more than mix drinks—they spark conversations.

**ACS** Satin, 24 oz. (710 mL)  
 4" Dia. x 9 1/4" H (10.2 x 23.5 cm)

**ACSH** Hammered, 24 oz. (710 mL)  
 4" Dia. x 9 1/4" H (10.2 x 23.5 cm)

## Beehive Cocktail Shakers

These three-piece beehive stainless steel shakers feature a high-polished mirror finish on the shaker, strainer top and jigger cap.

**BHS109** 8 oz. (240 mL)  
 2 5/8" Dia. x 6 3/8" H (6.7 x 16.2 cm)

**BHS117** 16 oz. (470 mL)  
 3 1/4" Dia. x 8" H (8.3 x 20.3 cm)

**BHS124** 24 oz. (710 mL)  
 3 1/2" Dia. x 8 7/8" H (8.9 x 22.5 cm)



ACS

ACSH



BHS109

BHS124

BHS117

### Three-Piece Cocktail Shakers HOT

**CSJ108** 8 oz. (240 mL)  
3 1/8" Dia. x 5 3/4" H (7.9 x 14.6 cm)

**CSJ116** 16 oz. (470 mL)  
3 1/8" Dia. x 7 1/2" H (7.9 x 19.1 cm)

**CSJ174** 28 oz. (830 mL)  
4" Dia. x 8 1/4" H (10.2 x 21 cm)

### Replacement Jigger Cup

**CSJCUP** 3 oz. (89 mL) (not shown)  
2" Dia. x 2 1/4" H (5.1 x 5.7 cm)

### Cocktail Shakers and Malt Cup

**CS080** Shaker  
8 oz. (240 mL)  
3" Dia. x 3 1/4" H (7.6 x 8.3 cm)

**CS200** Shaker  
16 oz. (470 mL)  
3 3/4" Dia. x 4 5/8" H (9.5 x 11.7 cm)

**CS100** Shaker  
28 oz. (800 mL)  
3 5/8" Dia. x 7" H (9.2 x 17.8 cm)

**MM100** Malt Cup  
32 oz. (950 mL)  
4 1/8" Dia. x 7" H (10.5 x 17.8 cm)

### Bar Glass/Mixing Glass USA

**MG578** 16 oz. (470 mL)  
3 3/8" Dia. x 5 7/8" H (8.6 x 14.9 cm)



COMES COMPLETE WITH INSCRIBED RECIPES







### Japanese-Style Stainless Steel Jiggers

<b>JG2</b>	½ oz. x ¾ oz. (14.8 x 22.2 mL)
<b>JG1</b>	½ oz. x 1 oz. (14.8 x 29.6 mL)
<b>JG12</b>	½ oz. x 1½ oz. (14.8 x 44.4 mL)
<b>JG14</b>	½ oz. x 1¼ oz. (14.8 x 37 mL)
<b>JG22</b>	1 oz. x 1¼ oz. (29.6 x 37 mL)
<b>JG2A</b>	¾ oz. x 1¼ oz. (22.2 x 37 mL)
<b>JG3</b>	¾ oz. x 1½ oz. (22.2 x 44.4 mL)
<b>JG4</b>	1 oz. x 1½ oz. (29.6 x 44.4 mL)
<b>JG5</b>	1 oz. x 2 oz. (29.6 x 59.1 mL)
<b>JG63</b>	1¼ oz. x 2 oz. (37 x 59.1 mL)

### Stainless Steel Jiggers

<b>J202</b>	½ oz. x ¾ oz. (14.8 x 22.2 mL)
<b>J201</b>	½ oz. x 1 oz. (14.8 x 29.6 mL)
<b>J214</b>	½ oz. x 1¼ oz. (14.8 x 37 mL)
<b>J212</b>	½ oz. x 1½ oz. (14.8 x 44.4 mL)
<b>J208</b>	⅝ oz. x 1¼ oz. (18.5 x 37 mL)
<b>J206</b>	¾ oz. x 1 oz. (22.2 x 29.6 mL)
<b>J202A</b>	¾ oz. x 1¼ oz. (22.2 x 37 mL)
<b>J203</b>	¾ oz. x 1½ oz. (22.2 x 44.4 mL)
<b>J222</b>	1 oz. x 1¼ oz. (29.6 x 37 mL)
<b>J204</b>	1 oz. x 1½ oz. (29.6 x 44.4 mL)
<b>J205</b>	1 oz. x 2 oz. (29.6 x 59.1 mL)
<b>J263</b>	1¼ oz. x 2 oz. (37 x 59.1 mL)
<b>J266</b>	1½ oz. x 2 oz. (44.4 x 59.1 mL)



### Evolution Tongs

These stainless steel tongs feature a 21st-century design with ergonomic styling.

<b>TGS8</b>	7 ¼" L (18.4 cm)
<b>TGS6</b>	6" L (15.2 cm)
<b>TGS9</b>	9 ½" L (24.1 cm)
<b>TGS12</b>	12" L (30.5 cm)



**Serving Tongs**

These versatile brushed stainless steel tongs can be used for anything from bread to ice cubes.

**TG8** Solid  
8 ½" L (21.6 cm)

**TGP8** Perforated  
8 ½" L (21.6 cm)

**Stainless Steel Utility Tongs**

Your basic utility tongs never go out of style.

**UT707** 7" L (17.8 cm)

**Stainless Steel Ice Tongs**

The serrated claws on these short tongs make gripping a breeze when time is at a premium.

**MSTNG5** 5" L (12.7 cm)





Shown with GBE8 glass beaker

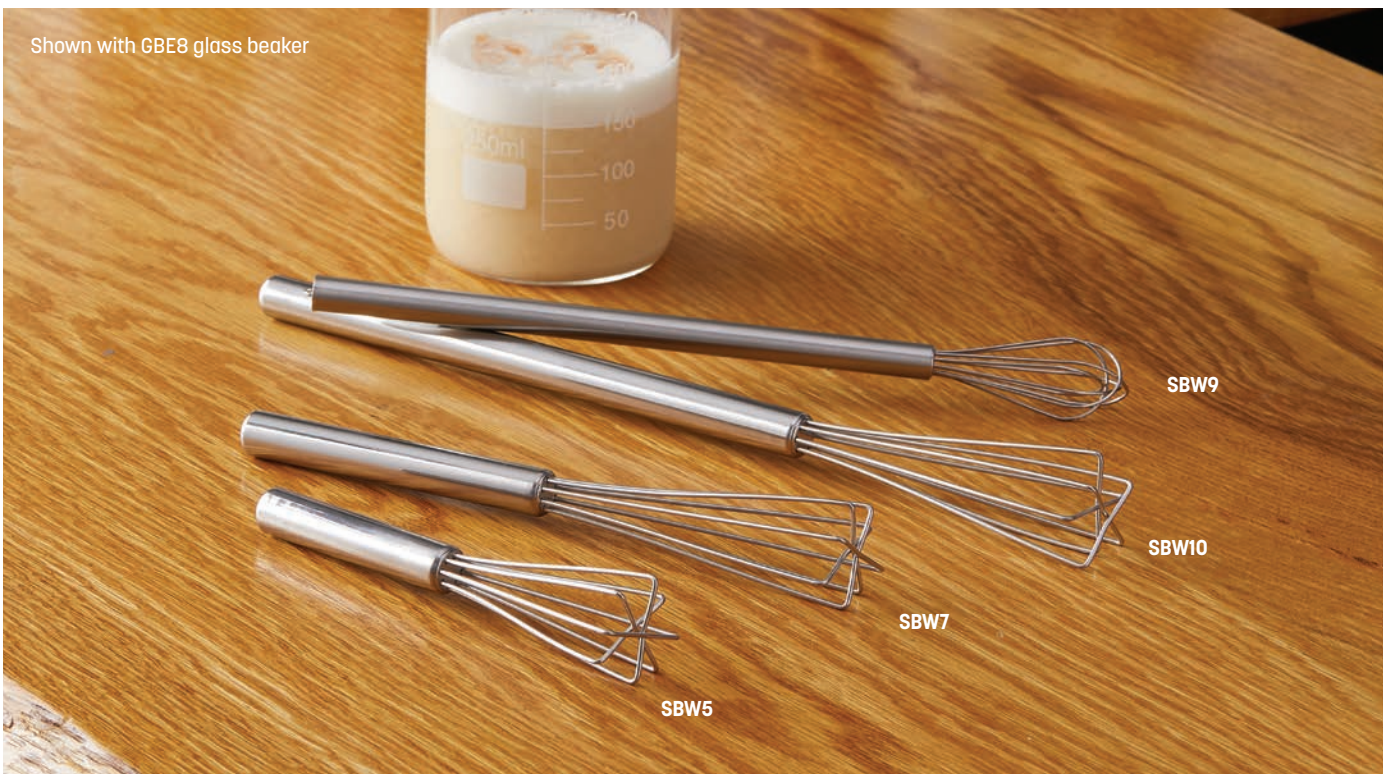

### Stainless Steel Bar Whisks

Cocktailing is an art. These whisks are a mixologist's right-hand memory maker.

- SBW5** Square  
5" L (12.7 cm)
- SBW7** Square  
7" L (17.8 cm)
- SBW9** Round  
9" L (22.9 cm)
- SBW10** Square  
10 ½" L (26.6 cm)

### Stainless Steel Bar Utensils

The bartender's arsenal of tools, all in one stylish collection. Each utensil is crafted from stainless steel and tipped with black rubber.

- SZ56** Zester  
6 ¾" L (17.1 cm)
- SM9** Cocktail Muddler  
9 ⅛" L (23.2 cm)

NEW



MWW10

MAW10

### Wood Muddlers NEW

Perfect for crushing fruits and herbs for delicious cocktails. Designed with a flat end to easily crush ingredients together.

**MAW10** Acacia  
10" L (25.4 cm)

**MWW10** Walnut  
10" L (25.4 cm)

### Stainless Steel Muddlers

These muddlers are expertly designed with ridges and rounded edges to offer a tighter and more comfortable grip in your hand.

**MDLR7** 7" L (17.8 cm)

**MDLR10** 10" L (25.4 cm)



MDLR10

MDLR7

### Plastic Muddler NEW

Add a burst of flavor to hand-crafted cocktails with our durable dishwasher-safe plastic muddler. Featuring a clever dual-sided design: the round side is perfect for softer muddling while the flat edge is ideal for tougher ingredients.

**MPS10** 10" L (25.4 cm)



NEW

MPS10





### Stainless Steel Tapered Liquor Pourers

Designed to match our supremely stylish bar tools, these tapered pourers add a touch of class to standard-sized liquor bottles. Dishwasher-safe. **Sold in a pack of 12.**

<b>TPRS</b>	Silver 1 ¼" Dia. x 4 ½" L (3.2 x 11.4 cm)
<b>TPRB</b>	Black 1 ¼" Dia. x 4 ½" L (3.2 x 11.4 cm)
<b>TPRG</b>	Gold 1 ¼" Dia. x 4 ½" L (3.2 x 11.4 cm)

### Japanese-Style Stainless Steel Jiggers

Upgrade your bar measuring tools with these dishwasher-safe Japanese-Style Jiggers. Available in a variety of dishwasher-safe sleek trendy finishes, each jigger features two different measuring capacities to craft the finest cocktails.

<b>JG4</b>	Silver 1 oz. x 1 ½ oz. (29.6 x 44.4 mL)
<b>JG5</b>	Silver 1 oz. x 2 oz. (29.6 x 59.1 mL)
<b>JGB4</b>	Black 1 oz. x 1 ½ oz. (29.6 x 44.4 mL)
<b>JGB5</b>	Black 1 oz. x 2 oz. (29.6 x 59.1 mL)
<b>JGG4</b>	Gold 1 oz. x 1 ½ oz. (29.6 x 44.4 mL)
<b>JGG5</b>	Gold 1 oz. x 2 oz. (29.6 x 59.1 mL)



### Stainless Steel Bar Spoons

A must-have for anywhere mixology is practiced, these sleek and simple weighted-handled spoons look great and make crafting cocktails a cinch. In your choice of finish. Dishwasher-safe.

**BSS12** Silver  
12" L (30.5 cm)

**BSB12** Black  
12" L (30.5 cm)

**BSG12** Gold  
12" L (30.5 cm)

### Bar Spoon/Strainer

Mix up popular cocktails while straining out ice and other ingredients with this two-in-one spoon and strainer. Made of durable stainless steel, this tool is a popular mainstay for any of today's mixologists.

**BSST12** 12" L (30.5 cm)







### Twisted Bar Spoons

Polished stainless steel with twisted shanks for appearance and durability.

- 510P** No Knob  
10" L (25.4 cm)
- 511P** No Knob  
11" L (27.9 cm)  
(not shown)
- 510K** Red Knob  
10" L (25.4 cm)
- 511K** Red Knob  
11" L (27.9 cm)  
(not shown)
- 512K** Red Knob  
12" L (30.5 cm)  
(not shown)

### Ice Scoops

Easily measure up ice for drinks and cocktails with these durable ice scoops.

- IS734** Cast Aluminum Scoop  
 ¼ cup (59.14 mL)  
7 ¾" L x 2 ¼" W (19.7 cm x 5.7 cm)
- IS900** Stainless Scoop  
½ cup (118.3 mL)  
9 ¼" L x 3 ⅜" W (23.5 x 8.6 cm)



### Paring Knives

Jazz up your cocktails with beautiful garnishes and tasty zest. Featuring professional-grade blades sharp enough to slice through hard-rind citrus fruit with total ease. Available in your choice of wood or stainless steel easy-grip handles.

- PKW8** Wood Handle Paring Knife  
8" L x 1" W, 3 ½" L Blade  
(20.3 x 2.5, 8.9 cm)
- PKS8** Stainless Steel Paring Knife  
7 ⅞" L x ⅞" W, 3 ½" L Blade  
(20 x 2.2, 8.9 cm)



### Combination Citrus Squeezer/Bottle Opener

This stainless steel lemon/lime squeezer performs double-duty at the bar.

**LSBO** 8 1/2" L x 2 1/2" W x 1 1/2" H  
(21.6 x 6.4 x 3.8 cm)



### Black Finish Squeezer

This heavy-duty metal squeezer with a black lacquered finish features oversized holes for pulp.

**LSB3** 8 1/2" L x 2 7/8" W x 2 3/8" H  
(21.6 x 7.3 x 6 cm)



### Bar Strainers

A staple item for every bar, strainers sift out ice and solid ingredients while allowing flavors to mingle in each cocktail. Available in multiple stainless steel options to fit specific crafting requirements. Dishwasher-safe.

**JS6** Julep Strainer  
6 1/4" L (15.9 cm)

**CS8** Mesh Conical Strainer  
9 1/4" L (23.5 cm)

**S208** 2-Prong Strainer  
5 1/2" L (14 cm)

**S209** 4-Prong Strainer  
5 3/4" L (14.6 cm)

**STC2** 2-Prong Tight Coil Strainer  
5 3/4" L (14.6 cm)

**STC4** 4-Prong Tight Coil Strainer  
6" L (15.2 cm)



### Lemon Lime Peeler

Professional tools ideal for the bar or the kitchen.

**106** Peeler/Zester, 6" L (15.2 cm)

### Bar Board

White pressed plastic with non-slip ridges. 1/2" (1.3 cm) thick for longer usage.

**BB6105** 10" L x 6" W x 1/2" H  
(25.4 x 15.2 x 1.3 cm)

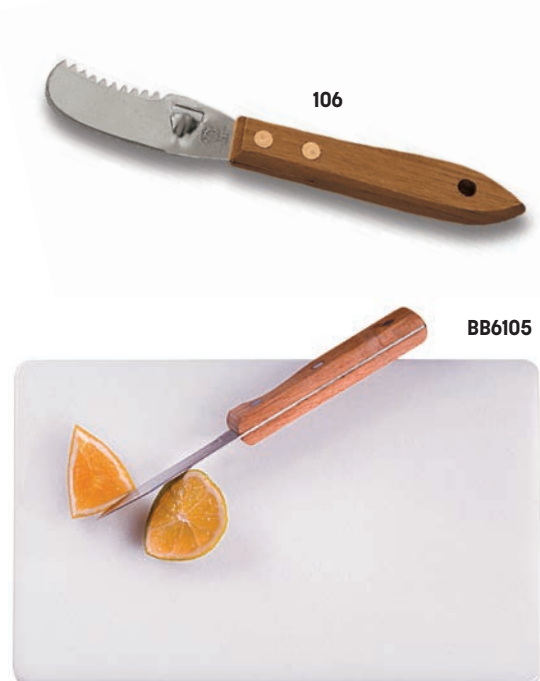





## Top-Shelf™ Waiter's Corkscrews

Choose from a variety of premium stainless steel corkscrews that are as beautiful as they are functional. All are top-shelf choices.

**WCRP** Red Pear Wood, Two-Stage  
4 ¼" L x 1" W x ½" H  
(10.8 x 2.5 x 1.3 cm)

**WCMA** Mahogany Wood, Two-Stage  
5 ¼" L x 1 ¼" W x ½" H  
(13.3 x 3.2 x 1.3 cm)

### Corkscrews

From a portable plastic corkscrew to stainless steel waiter's corkscrews and a deluxe-finished wing corkscrew, we have the perfect tool for every bottle.

**CS7545** Pocket Corkscrew  
4 ¼" L (10.8 cm)

**WCS871** Waiter's Straight Knife  
4 ¼" L x 1" W x ¼" H  
(10.8 x 2.5 x 0.6 cm)

**WCS867** Waiter's Curved Knife  
4 ½" L x 7⁄8" W x 7⁄8" H  
(11.4 x 2.2 x 2.2 cm)

**WCSB415** Waiter's Black Plastic  
4 ½" L x 1" W x 7⁄8" H  
(11.4 x 2.5 x 2.2 cm)

**CS301** Wing Corkscrew  
 6 ¼" L x 1 ¾" W  
(15.9 x 4.4 cm)

**WCS137** Waiter's Stainless Steel  
4 ¾" L x 1" W x ¼" H  
(11.1 x 2.5 x 0.6 cm)



### Stainless Steel Bar Trays and Liners

These bar trays feature a brushed stainless steel lip. Clear mesh liner sold separately.

#### Trays

**SSBT11** 11" Dia. (27.9 cm)

**SSBT14** 14" Dia. (35.6 cm)

#### Liners

**BTTL9** Liner for SSBT11  
9 1/4" Dia. (23.5 cm)

**BTTL11** Liner for SSBT14  
11 5/8" Dia. (29.5 cm)

### Double-Wall Hammered Wine Cooler

This stainless steel wine cooler features an elegant hammered design and double-wall insulation to keep bottles colder longer.

**DWWC5** 54 oz. (1.6 L)  
5 3/4" Dia. x 9 5/8" H  
(14.6 x 24.4 cm)



CAN ALSO SERVE AS A SHAREABLE DRINKING VESSEL







### Stainless Steel Wine Coolers

Brushed stainless steel coolers are suitable for wine and champagne bottles. Double-wall insulation keeps wine chilled for up to four hours.

**SWC48** Straight-Sided  
4 3/4" Dia. x 7 5/8" H (12.1 x 19.4 cm)

**HGWC1** Hourglass  
5 1/4" Dia. x 8" H (13.3 x 20.3 cm)

**SLWC2** Angled  
5 1/4" Dia. x 9 1/4" H (13.3 x 23.5 cm)

### Acrylic Wine Coolers

Double-wall construction provides insulation that keeps chilled wine at proper temperature for up to three hours. Can hold bottles up to 3" (9.52 cm) in diameter.

**AWC49** Clear, 5" W x 9" H (12.7 x 23.5 cm)

**WCFS462** Silver, 5" W x 9" H (12.7 x 23.5 cm)

### Marble Wine Coolers

Coolers keep wine or champagne at proper serving temperature without ice for up to two hours. Color may vary.

**MWC57** White, 5" Dia. x 7" H (12.7 x 17.8 cm)

**MWC59** Black, 5" Dia. x 7" H (12.7 x 17.8 cm)

### Wine Coasters

Choose from a shiny hammered design or a brushed satin finish on these double-wall coasters. Each performs double duty as great little snack servers too.

#### Silver

**SW4** 4 3/4" Dia. x 2 1/2" H (12.1 x 6.4 cm)

**DWBH4** 4 3/4" Dia. x 2 1/2" H (12.1 x 6.4 cm)

#### Gold

**GW4** 4 3/4" Dia. x 2 1/2" H (12.1 x 6.4 cm)

**GHW4** 4 3/4" Dia. x 2 1/2" H (12.1 x 6.4 cm)



### Silver-Thread Champagne Bucket and Wine Cooler

So understated and elegant, this double-wall champagne bucket and wine cooler feature brushed stainless steel finishes with polished and etched bases.

**SDWW5** Wine Cooler  
5 1/2" Dia. x 8 1/4" H (13.3 x 21 cm)

**SDWC7** Champagne Bucket  
8" Dia. x 8 5/8" H (20.3 x 21.9 cm)



### Gold Champagne Bucket and Wine Cooler NEW

Elegantly crafted to celebrate in style, our double-wall champagne bucket and wine cooler are brushed in a timeless gold finish.

**GDWW5** Wine Cooler  
5 1/2" Dia. x 8 1/4" H (13.3 x 21 cm)

**GDWC7** Champagne Bucket  
8" Dia. x 8 5/8" H (20.3 x 21.9 cm)



### Hammered Wine Buckets and Coolers

Choose from classic stainless steel or copper-plated stainless steel.

#### Stainless Steel

**HMWC75** Wine Cooler  
4 3/4" Dia. x 7 1/4" H (12.1 x 18.4 cm)

**WB9** Champagne Bucket  
9 3/8" L x 8" W x 8 3/8" H (23.8 x 20.3 x 21.3 cm)

#### Copper-Plated NEW

**SW4C** Wine Cooler  
4 3/4" Dia. x 7 1/4" H (12.1 x 18.4 cm)

**WB8C** Champagne Bucket  
9 3/8" L x 8" W x 8 3/8" H (23.8 x 20.3 x 21.3 cm)



NO TWO ARE ALIKE





SWSC



SWB, SWBSTND  
sold separately

### Swirl Wine Cooler

Featuring the same design as the Swirl Wine Bucket, this chiller adds an air of sophistication.

**SWSC** 4 1/2" Dia. x 7 1/4" H (11.4 x 18.4 cm)

### Swirl Wine Bucket and Stand

The embossed swirl design on this double-wall bucket fits seamlessly into the most sophisticated settings.

**SWB** Champagne Bucket  
5 qt. (4.7 L)  
8 3/4" Dia. x 8 5/8" H (22.9 x 21.9 cm)

**SWBSTND** Stand  
6 1/4" Dia. x 24" H (15.9 x 61 cm)

### Hammered Wine Bucket and Stand

This beautiful double-wall stainless steel wine bucket is a knockout on its own. Pair it with the matching stand for a tall, slender floor presentation.

**HMWB** Champagne Bucket  
5 qt. (4.7 L)  
8 3/4" Dia. x 8 5/8" H (22.9 x 21.9 cm)

**HMWBSTND** Stand  
6 1/8" Dia. x 24" H (15.6 x 61 cm)

### Oval Wine Bucket Stand

This hammered stainless steel bucket fits two wine or champagne bottles. Use the bucket on a tabletop or pair it with the stand for a perfect fit.

**O2BWB** 2-Bottle Wine Bucket  
7 qt. (6.6 L)  
8 3/8" L x 10 5/8" W x 9" H  
(21.3 x 27 x 22.9 cm)

**OWBS** Stand  
24 1/4" H (61.6 cm)



O2BWB  
bucket

OWBS  
stand



HMWB  
bucket

HMWBSTND  
stand

### Beverage Tub Stands

Our Hammered Double-Wall Party Tubs are impressive on their own. Elevate them with these stands and you'll have a serious showpiece on your hands. Each size features a wide foot for extra stability.

- BTS12** Holds DWBT15  
12 1/4" Dia. x 23 5/8" H (31.1 x 60 cm)
- BTS16** Holds DWBT185  
16" Dia. x 25" H (40.6 x 63.5 cm)

### Champagne Service

Choose from our hammered stainless steel wine bucket or our stainless steel champagne bucket and pair it with one of three stands.

- CHB32** Champagne Bucket Only  
8 qt. (7.6 L)  
8 3/4" Dia. x 10 1/2" H (22.2 x 26.7 cm)
- CS31** Champagne Stand Only  
28" H (71.1 cm)
- CBS33** Champagne Bucket and Stand  
8 qt. (7.6 L)  
8 3/4" Dia. x 10 1/2" H Bucket  
30 1/2" H (77.5 cm) with Stand  
(22.2 x 26.7 cm)
- WB9** Hammered Stainless Steel Bucket  
5 qt. (4.7 L)  
8" Dia. x 8 1/2" H (20.3 x 21.6 cm)
- WICS34** Ironworks Stand  
8" Dia. x 32 1/4" H (20.3 x 81.9 cm)
- WBS24** Stand  
6 3/8" Dia. x 23 1/2" H (16.2 x 59.7 cm)



### Martini Wine Stand

Bottle service goes meta with this clever stainless steel creation. It's also a dramatic way to serve chilled appetizers or desserts.

- WBSM42** 9 qt. (8.5 L)  
14 3/4" Dia. x 31 1/2" H x 8 1/2" Deep  
(37.5 x 80 x 21.6 cm)







ATHC9

ATHC14

ATHC10

ATHC16 shown with the ACS cocktail shaker, WC40 water carafe, ACT Moscow mule mug and BB2 glass bitters bottle



ATHG9

ATHG14

ATHG10

ATHG16

## Hammered Aluminum Beverage Tubs and Trays

Add a bit of charm to any occasion from your next brunch buffet to a private table service for two. Available in a variety of sizes, our Hammered Aluminum Beverage Tubs and Trays come in multiple beautiful finishes for a striking look wherever they're placed.

### Copper

- ATHC16** Tray, 16" Dia. x 2 ¾" H  
(40.6 x 7 cm)
- ATHC9** Tub, 7 ¾ qt. (7.3 L)  
12 ¼" L x 9" W x 8 ¾" H  
(31.1 x 22.9 x 22.2 cm)
- ATHC10** Tub, 10 qt. (9.4 L)  
15" L x 10 ¾" W x 7 ¼" H  
(38.1 x 27.3 x 18.4 cm)
- ATHC14** Tub, 16 ¼ qt. (15.3 L)  
19" L x 14" W x 8 ¼" H  
(48.3 x 35.6 x 21 cm)

### Gold

- ATHG16** Tray, 16" Dia. x 2 ¾" H  
(40.6 x 7 cm)
- ATHG9** Tub, 7 ¾ qt. (7.3 L)  
12 ¼" L x 9" W x 8 ¾" H  
(31.1 x 22.9 x 22.2 cm)
- ATHG10** Tub, 10 qt. (9.4 L)  
15" L x 10 ¾" W x 7 ¼" H  
(38.1 x 27.3 x 18.4 cm)
- ATHG14** Tub, 16 ¼ qt. (15.3 L)  
19" L x 14" W x 8 ¼" H  
(48.3 x 35.6 x 21 cm)

### Silver

- ATHS16** Tray, 16" Dia. x 2 ¾" H  
(40.6 x 7 cm)
- ATHS9** Tub, 7 ¾ qt. (7.3 L)  
12 ¼" L x 9" W x 8 ¾" H  
(31.1 x 22.9 x 22.2 cm)
- ATHS10** Tub, 10 qt. (9.4 L)  
15" L x 10 ¾" W x 7 ¼" H  
(38.1 x 27.3 x 18.4 cm)
- ATHS14** Tub, 16 ¼ qt. (15.3 L)  
19" L x 14" W x 8 ¼" H  
(48.3 x 35.6 x 21 cm)

### Black

- ATHB16** Tray, 16" Dia. x 2 ¾" H  
(40.6 x 7 cm)
- ATHB9** Tub, 7 ¾ qt. (7.3 L)  
12 ¼" L x 9" W x 8 ¾" H  
(31.1 x 22.9 x 22.2 cm)
- ATHB10** Tub, 10 qt. (9.4 L)  
15" L x 10 ¾" W x 7 ¼" H  
(38.1 x 27.3 x 18.4 cm)
- ATHB14** Tub, 16 ¼ qt. (15.3 L)  
19" L x 14" W x 8 ¼" H  
(48.3 x 35.6 x 21 cm)







### Square Hammered Tubs

These dishwasher-safe hammered stainless steel tubs are perfect for the most elegant events.

- STH6** 1 3/8 qt. (1.3 L)  
6" Sq. x 3 1/4" H  
(15.2 x 8.3 cm)
- STH8** 6 1/4 qt. (5.9 L)  
8" Sq. x 7 1/4" H  
(20.3 x 18.4 cm)
- STH14** 22 1/2 qt. (21.3 L)  
14" Sq. x 8 1/2" H  
(35.6 x 21.6 cm)
- STH16** 32 1/2 qt. (30.8 L)  
16 1/2" Sq. x 9 1/2" H  
(41.9 x 24.1 cm)

### Angled Hammered Tubs

Available in a variety of versatile sizes, these upscale stainless steel tubs are perfect for table service of wine or beer on ice.

- HMSR6** 2 qt. (1.9 L)  
6" Dia. x 7 1/2" H  
(15.2 x 43.7 cm)
- HMSR7** 3 qt. (2.8 L)  
7" Dia. x 8 1/2" H  
(17.8 x 21.6 cm)
- HMSR8** 5 qt. (4.7 L)  
8" Dia. x 9 1/2" H  
(20.3 x 24.1 cm)



### Acacia Marble Melamine Tub NEW

Get the look of acacia wood and marble with the durability of melamine in this trendy, upscale tub.

- JBASEMEL8** 7 1/2 qt. (7.1 L)  
11 1/4" Dia. x 7 3/4" H  
(28.6 x 19.7 cm)



## Party Tubs

### Stainless Steel

A dual satin and mirror finish dresses up this tub.

**STUB20** 25 ¼ qt. (24 L)  
20 ½" L x 15" W x 11 ½" H  
(51.1 x 38.1 x 28.3 cm)

### Galvanized

Hand-wash only. Not for use with acidic foods.

**GPTUB20** 25 ¼ qt. (24 L)  
20 ½" L x 15" W x 11" H  
(51.1 x 38.1 x 27.9 cm)

### Hammered Party Tub

Manufactured from heavy-duty stainless steel, our big party tub is individually crafted with a ball-peen hammer.

**HMDOB19149** 25 ¼ qt. (24 L)  
19 ½" L x 9" W x 13 ½" H  
(49.5 x 22.9 x 34.3 cm)

### Double-Wall Party Tubs HOT

These stainless steel tubs feature a mirror finish on the outside with a hammered accent band that runs around the middle. Inside is brushed stainless steel. Free-swinging decorative handles round out the look.

**DWBT15** 15 qt. (14.2 L)  
15" Dia. x 7" H (38.1 x 17.8 cm)

**DWBT185** 29 qt. (27.4 L)  
18 ½" Dia. x 9" H (47 x 22.9 cm)

### Punch Bowls

Stainless steel and an elegant profile deliver a one-two punch for large group beverage service.

#### Hammered

**HMPB12** 8 qt. (7.6 L)  
17" Dia. x 10 ⅞" H  
(43.2 x 27.6 cm)

**HMPB20** 13 qt. (12.3 L)  
18 ½" Dia. x 12" H  
(47 x 30.5 cm)



CHECK OUT PARTY TUB STANDS ON PG. 365

HMPB20

THESE STAINLESS STEEL PUNCH BOWLS ARE A REAL KNOCKOUT

HMPB12

DWBT15

DWBT185

HOT



DWIB40



### Top-Shelf Double-Wall Ice Bucket with Ice Tongs

Featuring a high-polished mirror finish, this stainless steel bucket comes with ice tongs and removable grating in the base for drainage.

**DWIB40** 40 oz. (1.2 L)  
5 7/8" Dia. x 7 1/2" H  
(14.9 x 19.1 cm)

### Satin Finish Double-Wall Ice Buckets with Ice Tongs

These little stainless steel ice buckets come in unique contemporary styles and are perfect for tableside service. Double-wall design keeps ice cooler longer. Features a removable grating in the base to drain water.

**ISSB4** 34 oz. (1 L)  
4 3/8" Dia. x 6 1/4" H  
(11.1 x 15.9 cm)

**ISSB6** 34 oz. (1 L)  
4 7/8" Dia. x 6 3/8" H  
(12.4 x 16.2 cm)

ISSB4



ISSB4, ISSB6,  
DWIB40  
ICE BUCKETS  
HAVE GRATING  
INSIDE



ISSB6



## Plastic Condiment Holder

Use this plastic container at the beverage bar, taco bar, omelet station or anywhere else! Features an easy-swing hinged lid and 1 1/2" (3.8 cm) deep storage base for ice.

**FCS16** 4-Compartment  
22 oz. (650.6 mL) each  
16" L x 6 1/4" W x 5 1/4" H  
(40.6 x 15.9 x 13.3 cm)

### Replacement Insert

**RC5** 22 oz. (650.6 mL) (not shown)  
5 3/4" L x 3 3/8" W x 2 3/4" H  
(14.6 x 9.2 x 7 cm)

## Stainless Steel Condiment Holders

A beautiful stainless steel finish sparkles on these condiment holders. Four, five or six compartments are perfect for keeping all of your garnishes in one place. The sanitary plastic containers fit inside, and a clear, plastic-hinged cover seals in freshness. 16 oz. (473.2 mL) plastic containers.

### Hammered Finish

**HMCD4** 4-Compartment  
12" L x 5 3/4" W x 3 1/2" H  
(30.5 x 14.6 x 8.9 cm)  
(not shown)

**HMCD5** 5-Compartment  
14 3/4" L x 5 3/4" W x 3 1/2" H  
(37.5 x 14.6 x 8.9 cm)  
(not shown)

**HMCD6** 6-Compartment  
17 3/4" L x 5 3/4" W x 3 1/2" H  
(45.1 x 14.6 x 8.9 cm)

### Satin Finish

**CD4** 4-Compartment  
12" L x 5 3/4" W x 3 1/2" H  
(30.5 x 14.6 x 8.9 cm)  
(not shown)

**CD5** 5-Compartment  
14 3/4" L x 5 3/4" W x 3 1/2" H  
(37.5 x 14.6 x 8.9 cm)  
(not shown)

**CD6** 6-Compartment  
17 3/4" L x 5 3/4" W x 3 1/2" H  
(45.1 x 14.6 x 8.9 cm)

## Black Finish

**CDB4** 4-Compartment  
12" L x 5 3/4" W x 3 1/2" H  
(30.5 x 14.6 x 8.9 cm)  
(not shown)

**CDB5** 5-Compartment  
14 3/4" L x 5 3/4" W x 3 1/2" H  
(37.5 x 14.6 x 8.9 cm)  
(not shown)

**CDB6** 6-Compartment  
17 3/4" L x 5 3/4" W x 3 1/2" H  
(45.1 x 14.6 x 8.9 cm)

### Replacement Insert

**PCI10** Plastic Insert for HMCD4, HMCD5, HMCD6, CD4, CD5, CD6, CDB4, CDB5, CDB6  
16 oz. (473.2 mL)

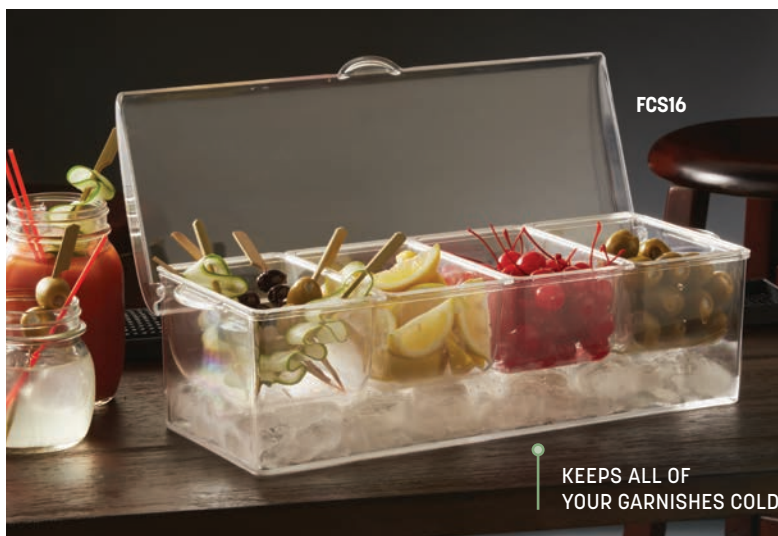





BARB7

BARB5

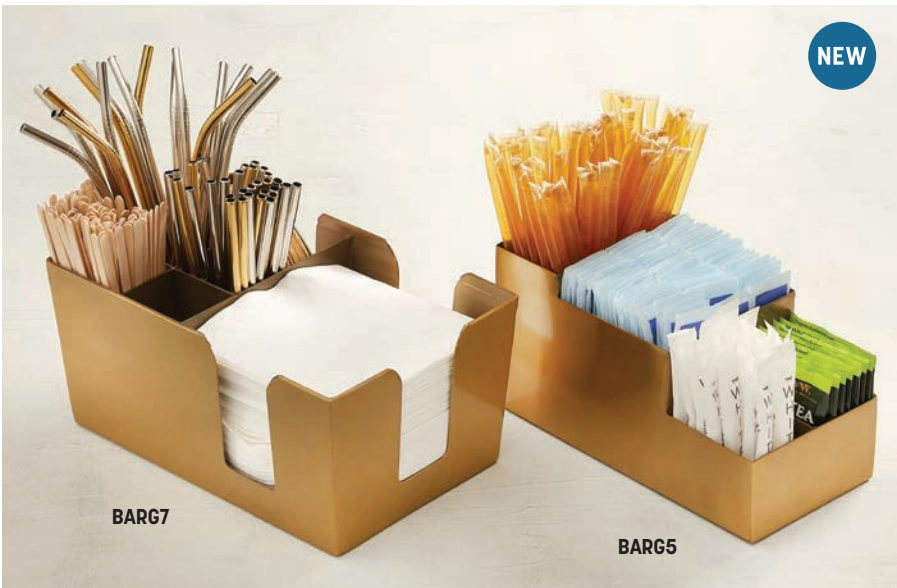

NEW

BARG7

BARG5

### Metal Bar and Coffee Caddies

Colorful bar accessories really “pop” in these metal caddies.

#### Black

**BARB5** 8" L x 4" W x 4 1/8" H  
(20.3 x 10.2 x 10.5 cm)

**BARB7** 9 1/8" L x 5 7/8" W x 4 1/8" H  
(23.2 x 14.9 x 10.5 cm)

#### Gold

**BARG5** 8" L x 4" W x 4" H  
(20.3 x 10.2 x 10.2 cm)

**BARG7** 9 1/8" L x 5 7/8" W x 4 1/8" H  
(23.2 x 14.9 x 10.5 cm)

#### Antique Copper

**BARC5** 8" L x 4" W x 4 1/8" H  
(20.3 x 10.2 x 10.5 cm)

**BARC7** 9 1/8" L x 5 7/8" W x 4 1/8" H  
(23.2 x 14.9 x 10.5 cm)



BARC7

BARC5



HMBAR8

BARS7

### Stainless Steel Caddies

**BARS7** Satin Finish  
 9 1/8" L x 5 7/8" W x 4 1/8" H  
 (23.2 x 14.9 x 10.5 cm)

**HMBAR8** Hammered Finish  
 9 1/8" L x 5 7/8" W x 4 1/8" H  
 (23.2 x 14.9 x 10.5 cm)

### Plastic Bar Caddy

Black plastic six-compartment organizer.

**BAR6** Black  
 9 1/2" L x 5 3/4" W x 4 1/8" H  
 (24.1 x 14.6 x 10.5 cm)



BAR6





NOT FOR SALE IN  
NEW ZEALAND  
OR ON MARS  
(SERIOUSLY)

LB027

SBO154



EBSS312

BBC39



### Bottle and Can Opener

Heavy-gauge tempered stainless steel opener with a hardwood handle.

**BBC39** Deluxe Bottle/Can Opener

 4 1/2" L (11.4 cm)

### Flat Bottle Openers

Slim, low-profile stainless steel design slips easily into pockets for convenient service.

**SBO154** 4 1/4" L (10.8 cm)

**LB027** 7" L (17.8 cm)

### Bottle Stoppers

Stop fizz and flavor from escaping with these plastic bottle stoppers. **Sold in a pack of 3.**

**EBSS312** Bottle Stoppers

### Champagne Bottle Stopper

This stainless steel stopper with high-gloss finish keeps champagne bubbly for up to two days.

**CHBST112** Champagne Bottle Stopper



CHBST112



**BLACKBM1218** shown with S208 strainer

ALSO AVAILABLE IN BROWN

**Service Mat**

One-piece rubber construction. 18" L x 12" W (45.7 x 30.5 cm).

**BROWNBM1218** Brown (not shown)

**BLACKBM1218** Black

**Deluxe Bar Mat**

One-piece rubber construction. 27" L x 3 1/4" W (68.6 x 8.3).

**BM23** Brown

**BLM24** Black



**BLM24** shown with J205 jigger

**BM23**

**Bar Tile** 

These 12" square (30.5 cm) molded vinyl tiles snap together. Textured surface prevents slippage, and feet improve drainage and air circulation.

**BT12X12** Black

**Bar Tray Mat**

Round black non-slip mat fits bar trays.

**BTTL13** 13" Dia. (33 cm)

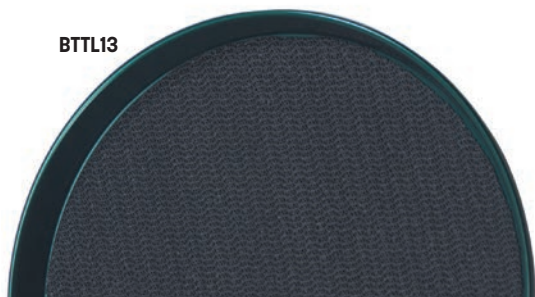

**BTTL13**

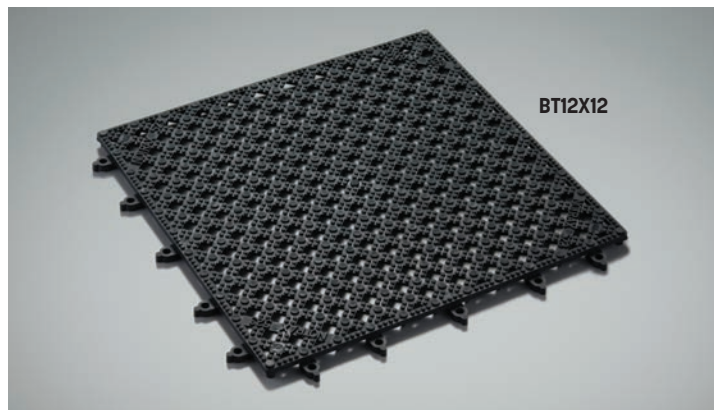

**BT12X12**



**WARNING:** This product can expose you to chemicals including Di(2-ethylhexyl)phthalate (DEHP) & Diisononyl Phthalate (DINP), which are known to the State of California to cause birth defects or other reproductive harm. For more information, go to <http://www.P65warnings.ca.gov>. Warning applies to State of California only.





GR1435

AVAILABLE IN TWO COLORS:  
WALNUT AND ESPRESSO



913ST

699ST

524ST

USA

### Glass Racks

A wide variety of glasses easily slip in and out of rack ends. Easy to assemble and hang. 35" L x 14" W x 1 1/2" H (88.9 x 35.6 x 3.8 cm).

**GR1435** Walnut

**RG5341** Espresso  
(not shown)

### Strainer Funnels

Spun 16-gauge aluminum with a built-in strainer. Makes disposing of accumulated debris easy.

**524ST** 1 pint (473 mL)  
1.25 mm

**699ST** 1 qt. (946 mL)  
1.25 mm

**913ST** 2 qt. (1.9 L)  
1.25 mm

Free-flow funnels are listed on pg. 396.



# Kitchen Supplies







DEVELOPS NON-STICK  
QUALITIES OVER TIME



## Fry Pans

In black or carbon steel, these non-coated fry pans tolerate high heat, making them safe for induction, oven and broiler.

### Black Steel

- BSFP8** 7 7/8" Dia. (20 cm)  
14 1/4" L (36.2 cm) Overall
- BSFP10** 9 1/2" Dia. (24.1 cm)  
17 7/8" L (43.5 cm) Overall
- BSFP11** 11 1/8" Dia. (28.3 cm)  
20 1/4" L (51.4 cm) Overall
- BSFP12** 12 1/2" Dia. (31.8 cm)  
23 1/4" L (59.1 cm) Overall

### Carbon Steel

- CSFP8** 8 1/8" Dia. (20.6 cm)  
14 1/2" L (36.8 cm) Overall
- CSFP10** 9 1/2" Dia. (24.8 cm)  
17 1/2" L (44.5 cm) Overall
- CSFP11** 11 1/8" Dia. (28.3 cm)  
20 1/4" L (51.4 cm) Overall
- CSFP12** 12" Dia. (30.5 cm)  
22" L (55.9 cm) Overall

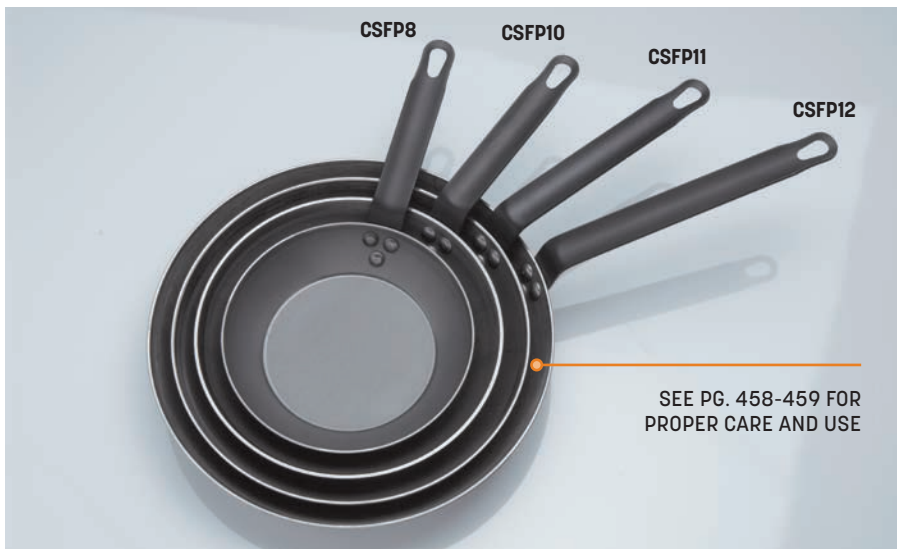

SEE PG. 458-459 FOR  
PROPER CARE AND USE

### Piano Whips - Sealed

Featuring stainless steel construction, sanitary sealed handles and flexible wire, these are perfect for whisking delicate sauces and batters.

<b>PW10</b>	10" L (25.4 cm)
<b>PW12</b>	12" L (30.5 cm)
<b>PW14</b>	14" L (35.6 cm)
<b>PW16</b>	16" L (40.6 cm)
<b>PW18</b>	18" L (45.7 cm)

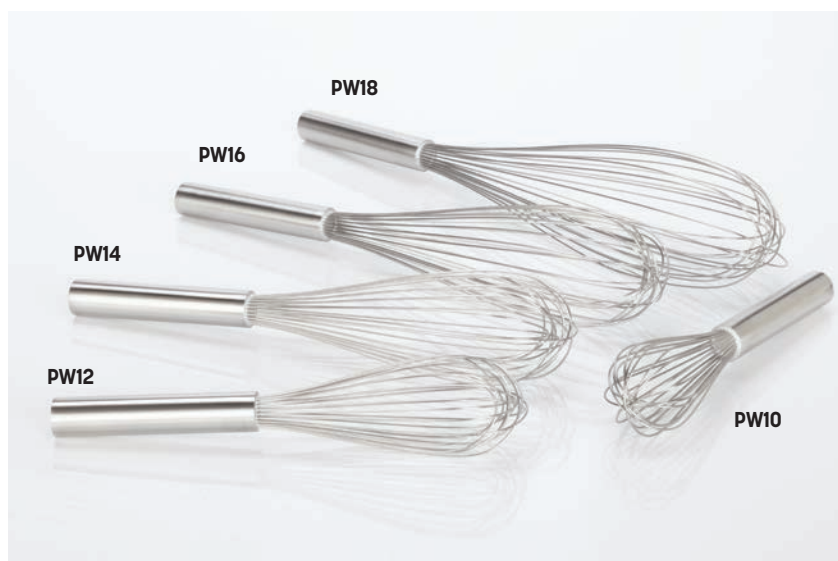

### One-Piece Ladles

All-purpose stainless steel ladles featuring heavy-gauge construction. Sizes are clearly marked for ease of use.

<b>L11005</b>	½ oz. (14.8 mL) 11" (27.8 cm) Handle
<b>L1101</b>	1 oz. (29.6 mL) 10 ½" (26.7 cm) Handle
<b>L11015</b>	1 ½ oz. (44.4 mL) 10 ¾" (27.3 cm) Handle
<b>L1102</b>	2 oz. (59.1 mL) 10 ¾" (27.3 cm) Handle
<b>L1103</b>	3 oz. (88.7 mL) 11 ¾" (29.8 cm) Handle
<b>L1104</b>	4 oz. (118.3 mL) 14" (35.6 cm) Handle
<b>L1105</b>	5 oz. (147.8 mL) 12 ½" (31.8 cm) Handle
<b>L1106</b>	6 oz. (177.4 mL) 12 ¾" (32.4 cm) Handle
<b>L1107</b>	7 oz. (207 mL) 12 ½" (31.8 cm) Handle
<b>L1108</b>	8 oz. (236.6 mL) 12 ¾" (31.1 cm) Handle (not shown)
<b>L1112</b>	12 oz. (354.8 mL) 12 ¾" (32.4 cm) Handle (not shown)

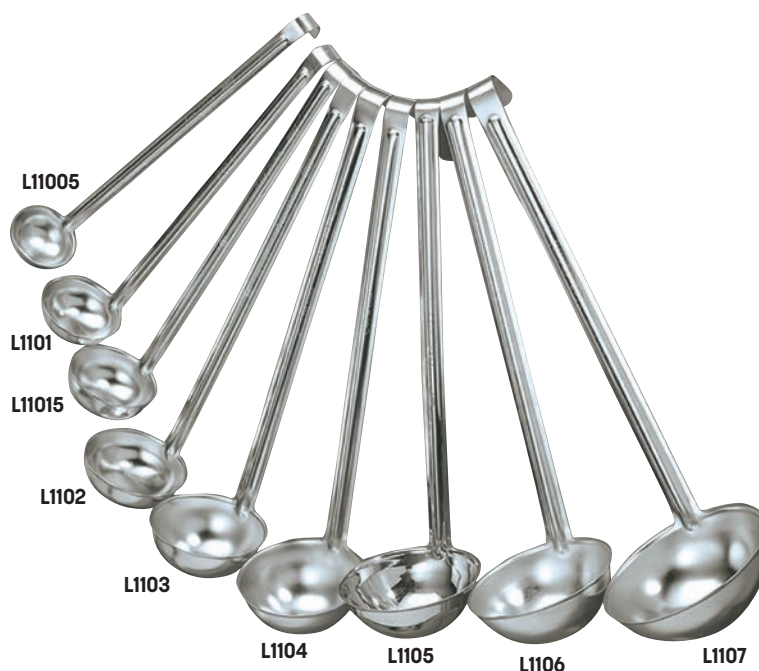

### Two-Piece Syrup Ladles

Stainless steel two-piece welded ladles stand up to sticky syrup, fudge, fruit and gravy.

<b>L210</b>	1 oz. (29.6 mL) 7" (17.8 cm) Handle
<b>L215</b>	1 ½ oz. (44 mL) 7" (17.8 cm) Handle
<b>L220</b>	2 oz. (59.1 mL) 7" (17.8 cm) Handle







## Thumb Dishers

Stainless steel with color-coded poly handles. Scoop number printed on finger guard and bowl sweep. Full-loop release bar.

<b>NSPDS6</b>	White, #6 9" L (22.9 cm) Overall
<b>NSPDS8</b>	Gray, #8 9" L (22.9 cm) Overall
<b>NSPDS10</b>	Ivory, #10 8 5/8" L (21.9 cm) Overall
<b>NSPDS12</b>	Green, #12 8 7/8" L (22.5 cm) Overall
<b>NSPDS16</b>	Blue, #16 8 3/8" L (21.3 cm) Overall
<b>NSPDS20</b>	Yellow, #20 8 3/8" L (21.3 cm) Overall
<b>NSPDS24</b>	Red, #24 8" L (20.3 cm) Overall
<b>NSPDS30</b>	Black, #30 8" L (20.3 cm) Overall
<b>NSPDS40</b>	Orchid, #40 7 1/2" L (19.1 cm) Overall
<b>NSPSSPRING</b>	Replacement Springs

## Ice Cream Spade

Stainless steel spade with a durable black plastic handle for serving even the most frozen ice creams.

<b>CRM922</b>	Stainless Steel Blade 3" L x 3 1/2" W (7.6 x 8.9 cm) 9" L (22.9 cm) Overall
---------------	---

### THUMB DISHER PORTION CONTROL CHART

Size	Dia. of Bowl	Fluid Capacity	Patties (lb)	Scoops (qt.)
6	3" (7.62 cm)	5 oz. (147.9 mL)	1	6
8	2 3/4" (6.99 cm)	4 oz. (118.3 mL)	3	8
10	2 5/8" (6.67 cm)	3.20 oz. (94.6 mL)	4	10
12	2 1/2" (6.35 cm)	2.66 oz. (78.7 mL)	5	12
16	2 1/4" (5.72 cm)	2 oz. (59.1 mL)	6-8	16
20	2 1/6" (5.24 cm)	1.60 oz. (47.3 mL)	9-10	20
24	1 29/32" (4.84 cm)	1.30 oz. (38.4 mL)	11-12	24
30	1 3/4" (4.45 cm)	1.05 oz. (31 mL)	13-14	30
40	1 5/8" (4.13 cm)	0.81 oz. (24 mL)	15-16	40



CRM922

### Bakelite Handle Spoons

Stainless steel spoons with Bakelite handles. Available in three differently styled bowls. 13" L (33 cm) overall.

- 132SL** Slotted Bowl
- 130SO** Solid Bowl
- 131PE** Perforated Bowl



### Spooners

One-piece stainless steel construction. Choose between solid and perforated bowls. Featuring color-coded Bakelite 10 3/4" (27.3 cm) grip handles.

#### Solid Bowl

- SPN2** Red  
2 oz. (59.1 mL)  
2 1/2" Dia. (6.4 cm)
- SPN3** Beige  
3 oz. (88.7 mL)  
3" Dia. (7.6 cm)
- SPN4** Green  
4 oz. (118.3 mL)  
3 3/8" Dia. (8.6 cm)
- SPN5** Yellow  
5 oz. (147.8 mL)  
3 1/2" Dia. (8.9 cm)
- SPN6** Black  
6 oz. (177.4 mL)  
3 3/4" Dia. (9.5 cm)
- SPN8** Blue  
8 oz. (236.6 mL)  
4" Dia. (10.2 cm)



#### Perforated Bowl

- SPNP2** Red  
2 oz. (59.1 mL)  
2 1/2" Dia. (6.4 cm)
- SPNP3** Beige  
3 oz. (88.7 mL)  
3" Dia. (7.6 cm)
- SPNP4** Green  
4 oz. (118.3 mL)  
3 3/8" Dia. (8.6 cm)
- SPNP5** Yellow  
5 oz. (147.8 mL)  
3 1/2" Dia. (8.9 cm)
- SPNP6** Black  
6 oz. (177.4 mL)  
3 3/4" Dia. (9.5 cm)
- SPNP8** Blue  
8 oz. (236.6 mL)  
4" Dia. (10.2 cm)







## Wire-Handled Measuring Cups

### Long-Handled

These stainless steel measuring cups feature extra-long handles to minimize hand-to-food contact. Sold individually.

<b>MCL14</b>	¼-Cup (59.1 mL) 8 ⅞" L (20.6 cm) Overall
<b>MCL13</b>	⅓-Cup (78.9 mL) 8 ½" L (21.6 cm) Overall
<b>MCL12</b>	½-Cup (118.3 mL) 8 ⅞" L (22.5 cm) Overall
<b>MCL75</b>	¾-Cup (177.4 mL) 9 ¼" L (23.5 cm) Overall
<b>MCL10</b>	1 Cup (236.6 mL) 9 ⅞" L (23.2 cm) Overall
<b>MCL125</b>	1 ¼-Cup (295.7 mL) 9 ¾" L (24.8 cm) Overall
<b>MCL150</b>	1 ½-Cup (354.9 mL) 9 ⅝" L (24.4 cm) Overall
<b>MCL175</b>	1 ¾-Cup (414 mL) 10" L (25.4 cm) Overall
<b>MCL200</b>	2 Cup (473.2 mL) 10 ¼" L (26 cm) Overall

### Short-Handled

<b>MCW4</b>	Set of 4 ¼-Cup (59.1 mL), ⅓-Cup (78.9 mL), ½-Cup (118.3 mL) and 1 Cup (236.6 mL)
<b>MCW14</b>	¼-Cup (59.1 mL) 5 ⅜" L (13.7 cm) Overall
<b>MCW13</b>	⅓-Cup (78.9 mL) 5 ⅝" L (14.3 cm) Overall
<b>MCW12</b>	½-Cup (118.3 mL) 5 ⅞" L (14.9 cm) Overall
<b>MCW75</b>	¾-Cup (177.4 mL) 6 ⅞" L (15.6 cm) Overall
<b>MCW10</b>	1 Cup (236.6 mL) 6 ½" L (16.5 cm) Overall
<b>MCW125</b>	1 ¼-Cup (295.7 mL) 7 ¼" L (18.4 cm) Overall
<b>MCW150</b>	1 ½-Cup (354.9 mL) 7 ½" L (19.1 cm) Overall
<b>MCW175</b>	1 ¾-Cup (414 mL) 8 ⅞" L (20.6 cm) Overall
<b>MCW200</b>	2 Cup (473.2 mL) 8 ⅞" L (21.6 cm) Overall

### Flat-Handled Measuring Cup Set

<b>MCL4</b>	Set of 4 ¼-Cup (59.1 mL), ⅓-Cup (78.9 mL), ½-Cup (118.3 mL) and 1 Cup (236.6 mL)
-------------	--

## Stainless Steel Measuring Spoon Sets

Different designs available in sets of four different capacities held together by O-rings

**MSSS73** 1 Tablespoon (14.8 mL), 1 Teaspoon (4.9 mL),  
½ Teaspoon (2.5 mL), ¼ Teaspoon (1.2 mL)

**MSSR74** 1 Tablespoon (14.8 mL), 1 Teaspoon (4.9 mL),  
½ Teaspoon (2.5 mL), ¼ Teaspoon (1.2 mL)

**MSSF75** 1 Tablespoon (14.8 mL), ½ Tablespoon (7.4 mL),  
1 Teaspoon (4.9 mL), ½ Teaspoon (2.5 mL)



## Dredge

Made of durable plastic, this transparent dredge is dishwasher-safe, as well as stain and odor-resistant. Holds 10 oz. (295 mL). Each unit is shipped with a coarse, medium and fine lid.

**10SD** Dredge with 3 Tops  
4" L x 3" W x 3 ¾" H  
(10.2 x 7.6 x 9.5 cm)

### Replacement Dredge Lids

**T10SDC** Coarse Top  
3 ⅛" Dia. x ¾" H  
(7.9 x 0.9 cm)

**T10SDM** Medium Top  
3 ⅛" Dia. x ¾" H  
(7.9 x 0.9 cm)

**T10SDF** Fine Top  
3 ⅛" Dia. x ¾" H  
(7.9 x 0.9 cm)



## Hand-Crank Cheese Graters

Choose between two easy-to-use graters. The plastic model comes with interchangeable stainless steel cylinders for thin strips, medium grating or fine grating. The stylish stainless steel model comes with one cylinder.

**PCG9** Plastic  
7 ¾" L x 2 ⅝" W x 3 ½" H  
(19.7 x 6.7 x 8.9 cm)

**SCG8** Stainless Steel  
8 ⅝" L x 3 ⅝" W x 2 ⅞" H  
(21.9 x 9.2 x 7.3 cm)



## China Cap Strainers

Heavy-gauge stainless steel with permanently welded handle, band and clip. Comes in your choice of cone and perforation sizes.

### Fine - ⅛" (1.59 mm) Perforations

**CC10F** 10" ID x 10" D x 20" L  
(25.4 x 25.4 x 50.8 cm)

**CC12F** 12" ID x 12" D x 22" L  
(30.5 x 30.5 x 55.9 cm)

### Coarse - ⅜" (2.38 mm) Perforations

**CC10C** 10" ID x 10" D x 20" L  
(25.4 x 25.4 x 50.8 cm)

**CC12C** 12" ID x 12" D x 22" L  
(30.5 x 30.5 x 55.9 cm)







## French Fry Scoops

Choose between right-handed or ambidextrous use. Crafted from stainless steel with plastic handles to protect hands from heat.

- FFSR1** Right Handle  
9" L x 8 1/2" W x 2 1/2" H  
(22.9 x 21.6 x 6.4 cm)
- FFSD3** Dual Handle  
9" L x 8 1/2" W x 2 1/2" H  
(22.9 x 21.6 x 6.4 cm)
- FFHANDLE** Replacement Handle  
4 1/4" L x 1 1/8" W x 1" H  
(10.8 x 2.9 x 2.5 cm)

## Aluminum Scoops

Heavy-duty all-purpose scoops crafted from brightly finished cast aluminum with easy-grip handles.

- ASC5** 5 oz. (147.9 mL)  
4 3/4" L x 2 3/8" W Bowl  
7 1/4" L with Handle  
(12.1 x 6, 18.4 cm)
- ASC12** 12 oz. (354.8 mL)  
5 7/8" L x 3 1/4" W Bowl  
8 1/2" L with Handle  
(14.9 x 8.3, 21.6 cm)
- ASC24** 24 oz. (709.7 mL)  
7" L x 4" W Bowl  
10 1/4" L with Handle  
(17.8 x 10.2, 26 cm)
- ASC38** 38 oz. (1.12 L)  
8 5/8" L x 4 7/8" W Bowl  
11 7/8" L with Handle  
(21.9 x 12.4, 30.2 cm)
- ASC58** 8 oz. (1.72 L)  
10 1/4" L x 5 1/4" W Bowl  
14" L with Handle  
(26 x 13.3, 35.6 cm)
- ASC84** 84 oz. (2.49 L)  
11 3/8" L x 6 1/2" W Bowl  
15 3/4" L with Handle  
(28.9 x 16.5, 40 cm)



## Polycarbonate Scoops

Scoop ice and other bulk ingredients with these clear, polycarbonate measures specifically designed to handle the rigors of foodservice. Made of durable and dishwasher-safe polycarbonate with easy-to-grip handles, these scoops will surely make measuring easy. Available in multiple capacities.

- PCSC6** 6 oz. (177.4 mL)  
10 1/2" L x 2 3/8" W Bowl  
(26.7 x 6 cm)
- PCSC12** 12 oz. (354.9 mL)  
11 3/8" L x 2 7/8" W Bowl  
(28.9 x 7.3 cm)
- PCSC24** 24 oz. (709.8 mL)  
12 3/8" L x 4" W Bowl  
(31.4 x 10.2 cm)



**WARNING:** This product can expose you to chemicals including Bisphenol A (BPA), which is known to the State of California to cause birth defects or other reproductive harm. For more information, go to [www.P65warnings.ca.gov](http://www.P65warnings.ca.gov). Warning applies to State of California only.

### Bowl Scraper/Dough Scraper/ Cake Decorator

A versatile tool made from durable hard plastic. ¼" hole (6 mm).

**BS64** 5 ½" L x 3 ¾" W (14.3 x 9.5 cm)

### Slant-Edge Scrapers

Stainless steel blades with slanted edges and beautiful wooden handles.

**SSC17** 3" W (7.6 cm) Blade  
7 ½" L (19.1 cm) Overall

**SSC19** 4" W (10.2 cm) Blade  
8 ¼" L (21 cm) Overall

**SSC18** 3" W (7.6 cm) Blade  
12" L (30.5 cm) Overall

### Heat-Resistant Scrapers

Long cool-touch handles and stain-resistant blades add up to smart, safe kitchen work. Dishwasher-safe and heat resistant up to 500° F (260° C).

**PHBS10** 2 ⅛" W (5.4 cm) Blade  
10 ½" L (26.7 cm) Overall

**PHBS14** 2 ¾" W (7 cm) Blade  
14" L (35.6 cm) Overall

**PHBS16** 2 ¾" W (7 cm) Blade  
16 ¼" L (41.3 cm) Overall

### Dough Cutters and Scrapers

Rounded corners will not scratch or damage trays.

**DS6704** Wood-Handled  
4 ½" L (11.4 cm)

**DSP6705** Plastic-Handled  
4 ½" L (11.4 cm)

**DS6706** Wood-Handled  
6" L (15.2 cm)

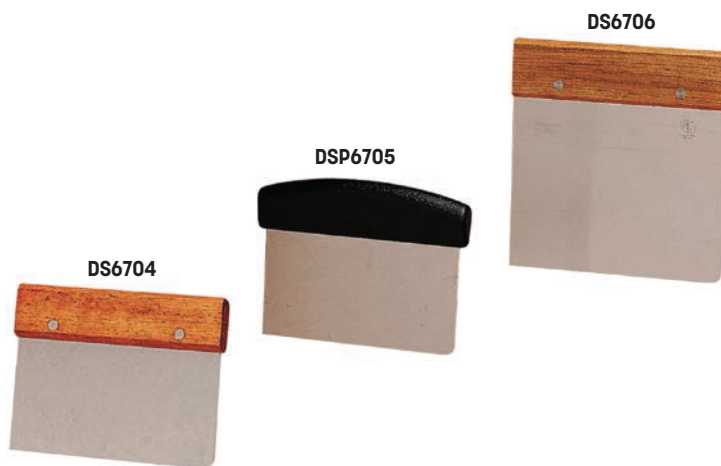





### Wood-Handled Turners

Stainless steel offset blades and wood handles. Available with straight or rounded edges.

#### Giant "Oversize" Turners

- LT20** 8" L x 3" W Blade, 20" L Overall (20.3 x 7.6, 50.8 cm)
- 19008** 8" L x 4" W Blade, 15 3/4" L Overall (20.3 x 10.2, 40 cm)
- LT198** 8" L x 4" W Blade, 20" L Overall (20.3 x 10.2, 50.8 cm)

#### 14" (35.6 cm) Long Overall with 8" Blade

- LT14** Rounded Blade  
8" L x 3" W (20.3 x 7.6 cm)
- LT14ST** Straight Blade  
8" L x 3" W (20.3 x 7.6 cm)
- LT14P** Rounded Perf Blade  
8" L x 3" W (20.3 x 7.6 cm)

#### 12" (30.5 cm) Long Overall with 6" Blade

- LT12** Rounded Blade  
6" L x 3" W (15.2 x 7.6 cm)
- LT12ST** Straight Blade  
6" L x 3" W (15.2 x 7.6 cm)

### Plastic-Handled Turners

Stainless steel offset blades and dark brown plastic handles. Available with straight or rounded edges.

#### 14" (35.6 cm) Long Overall with 8" Blade

- PS14** Rounded Blade  
8" L x 3" W (20.3 x 7.6 cm)
- PS14P** Rounded Perf Blade  
8" L x 3" W (20.3 x 7.6 cm)

#### 12" (30.5 cm) Long Overall with 6" Blade

- PS12ST** Straight Blade  
6" L x 3" W (15.2 x 7.6 cm)
- PS12** Rounded Blade  
6" L x 3" W (15.2 x 7.6 cm)

### Pressed Wood Servers

Made of pressed wood fiber, these dishwasher-safe serving utensils offer affordable convenience to any operation.

- MPS12** Spatula  
12" L (30.5 cm)
- MPT12** Turner  
12" L (30.5 cm)



## Wood-Handled Hamburger Turners / Pizza Servers

Stainless steel offset blades with straight edges.

**19007** 5" L x 3" W Blade  
11 5/8" L Overall  
(12.7 x 7.6, 29.5 cm)

**19075** 6" L x 4" W Blade  
11 5/8" L Overall  
(15.2 x 10.2, 29.5 cm)

## Heavy-Duty Hamburger Turners / Pizza Servers

Stainless steel offset blades and black plastic handles. Available with straight or rounded edges.

**PS197** 5" L x 3" W Blade  
11 5/8" L Overall  
(12.7 x 7.6, 29.5 cm)

**PS19075** 6" L x 4" W Blade  
11 5/8" L Overall  
(15.2 x 10.2, 29.5 cm)

## Giant "Oversize" Turner

**PS19008** 8" L x 4" W Blade  
15 3/4" L Overall  
(20.3 x 10.2, 40 cm)

## Assorted Servers

### Plastic-Handled Turner

Stainless steel offset blade with rounded edges.

**PS10** 3 5/8" L x 1 7/8" W Blade  
10" L Overall  
(9.2 x 4.8, 25.4 cm)

### Wood-Handled Pie Server/Pizza Server

Stainless steel with a flexible tapered offset blade.

**19006** 5" L x 2 1/2 - 1 1/2" W Blade  
10 1/2" L Overall  
(12.7 x 6.3 - 3.8, 26.7 cm)

### Slotted Fish Spatula

A specially shaped stainless steel blade and polypropylene handle make this an essential for anyone who serves fish.

**PSFSP** 6 1/2" L x 2 7/8" W Blade  
11 3/4" L Overall  
(16.5 x 7.3, 29.8 cm)

### Pie Server/Pizza Server

Stainless steel with a flexible tapered offset blade and dark brown plastic handle.

**PS196** 5" L x 2 1/2 - 1 1/2" W Blade  
10 1/2" L Overall  
(12.7 x 6.3 - 3.8, 26.7 cm)

### Deluxe Stainless Steel Server

Straight out of our Buffet & Display section, this beautiful server features a sleek design that works for the back of the house as well as the front.

**SW12PAS** 11" L Server (27.9 cm)



19007

19075

PS197

PS19075

PS19008



PS10

19006

PSFSP

PS196

SW12PAS





### Utility Tongs

#### Heavy-Weight (not shown)

0.7 mm stainless steel with tempered flat steel springs.

- UT707** 7" L (17.8 cm)
- UT975** 10" L (25.4 cm)
- UT1200** 12" L (30.5 cm)
- UT1600** 16" L (40.6 cm)
- FS911** Replacement Spring

#### Extra-Heavy Weight

1.2 mm stainless steel with tempered flat steel springs.

- HDUT975** 10" L (25.4 cm)
- HDUT1200** 12" L (30.5 cm)
- HDUT1600** 16" L (40.6 cm) w/ Double Flat Spring
- FS911** Replacement Spring

### Heavy-Duty Stainless Steel Pastry or Meat Tongs

You will get years of use from these durable multi-use tongs.

- IT878** 9 1/2" L (24.1 cm)

### Salad Server/Pastry Tongs

These elegant stainless steel tongs are perfect for serving individual portions.

- SS782** 8" L (20.3 cm)



### Square Fine Mesh Skimmers HOT

Nickel-plated and durable with 14" (35.6 cm) handle.

**SKS514** 5" Sq. (12.7 cm)

**SKS714** 7" Sq. (17.8 cm)

### Round Mesh Culinary Baskets

These classic nickel-plated strainers are 3" (7.6 cm) deep with 9" (22.9 cm) handles.

#### Fine Mesh

**CBF8** 8" Dia. (20.3 cm)  
(not shown)

**CBF9** 9" Dia. (22.9 cm)  
(not shown)

**CBF10** 10" Dia. (25.4 cm)  
(not shown)

**CBF12** 12" Dia. (30.5 cm)

#### Coarse Mesh

**CBC8** 8" Dia. (20.3 cm)  
(not shown)

**CBC9** 9" Dia. (22.9 cm)  
(not shown)

**CBC10** 10" Dia. (25.4 cm)  
(not shown)

**CBC12** 12" Dia. (30.5 cm)

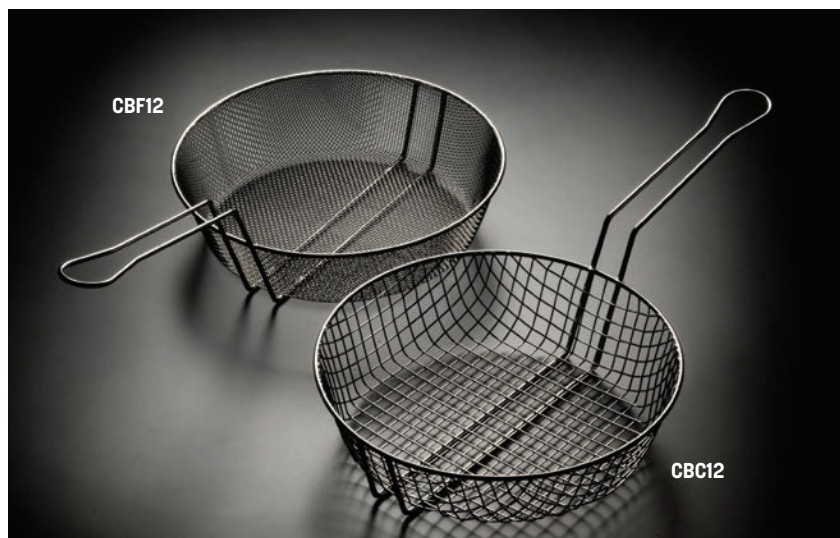





ISW2

ISW3



AHM485

### Steak Weights

Cast iron weights featuring wooden handles. It's hard to improve upon this classic design.

ISW2 8" L x 4" W (20.3 x 10.2 cm)

ISW3 9" L x 5" W (22.9 x 12.7 cm)

### Adjustable Burger Mold

Take control of portions with this adjustable mold. Crafted from heavy cast aluminum, this handy tool can press patties up to 3 1/2 oz. (103.5 mL).

AHM485 4 1/2" Dia. (11.4 cm)



1423

American METALCRAFT, Inc.

### Broiler Brush

With one semi-stiff side and one extra-stiff side, this tempered stainless steel scraper can clean even the most burned-on foods. Handle has metal-threaded tip for extra durability and safety.

1423 31" L x 8 1/2" W x 5" H (78.7 x 21.6 x 12.7 cm)



### Cedar Planks

Create smoky flavors the classic way. Simply soak the planks in water, add fish, appetizers or veggies and fire up the grill. Sold in a pack of 12.

CWP7 6 1/2" L x 3 1/2" W x 1/4" H (16.5 x 8.9 x 0.6 cm)

CWP8 8" L x 5 1/2" W x 1/4" H (20.3 x 14 x 0.6 cm)

CWP12 11 7/8" L x 5 1/2" W x 1/4" H (30.2 x 14 x 0.6 cm)

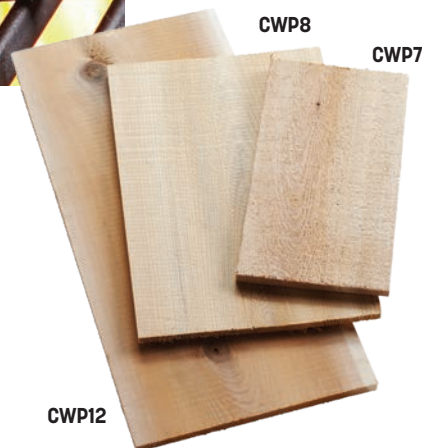

CWP8

CWP7

CWP12



1347

### Wire Brush with Scraper

With tempered steel bristles and a wooden handle.

**1347** 1 1/8" (2.9 cm) Bristles  
14" L x 2 1/2" H (35.6 x 6.4 cm)

### Egg Slicer

Made from die-cast aluminum. Makes oval or round slices.

**ES474** 4 1/4" Dia. x 1 1/4" H (10.8 x 3.2 cm)

### Coil-Handle Egg Rings

Heavy chrome plating on half round wire. 3/8" high (0.95 cm) wall.

**ER333** 3 1/4" Dia. (8.3 cm) Ring  
3 5/8" H (9.2 cm) with Handle

**ER444** 4 3/8" Dia. (11.1 cm) Ring  
4 7/8" H (12.4 cm) with Handle

### Standard Egg Rings

Rings and handles made from stainless steel. 1" high (2.54 cm) wall to prevent leaks.

**ER387** 4" Dia. (10.2 cm) Ring  
2 3/4" H (7 cm) with Handle

**ER487** 5" Dia. (12.7 cm) Ring  
2 3/4" H (7 cm) with Handle

**ER587** 6" Dia. (15.2 cm) Ring  
2 3/4" H (7 cm) with Handle



CHOOSE THE SHAPE OF THE SLICES FOR PERFECT PRESENTATION

ES474



ER333

ER444

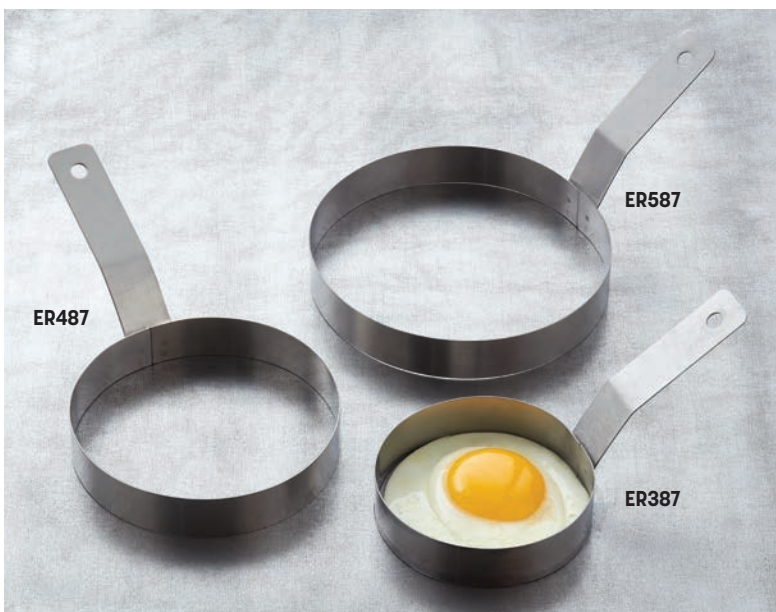

ER487

ER587

ER387



Shown with PW14 whisk and MCL10, MCW10 measuring cups



### Crave Collection Mixing Bowls BPA FREE

The Crave Collection hits the kitchen with these durable yet delightful mixing bowls. Available in the popular dinnerware colors (Cloud, Shadow and Storm) and complete with the organic texture that has made Crave so popular, these bowls can easily perform double duty as serving bowls.

**CBL54ST** Storm, 54 oz. (1.6 L)  
7 5/8" Dia. x 4 1/8" H  
(19.4 x 10.5 cm)

**CBL96SH** Shadow, 96 oz. (2.8 L)  
9 1/4" Dia. x 4 7/8" H  
(23.5 x 12.4 cm)

**CBL141CL** Cloud, 141 oz. (4.2 L)  
10 1/2" Dia. x 5 1/2" H  
(26.7 x 14 cm)

### Stainless Steel Mixing Bowls HOT

In a huge range of ten different sizes, these are the only mixing bowls you'll ever need.

**SSB75** 21 oz. (621 mL)  
6 1/2" Dia. x 2" H  
(16.5 x 5.1 cm)

**SSB150** 36 oz. (1.1 L)  
7 7/8" Dia. x 2 1/2" H  
(20 x 6.4 cm)

**SSB200** 55 oz. (1.6 L)  
8 1/2" Dia. x 2 3/4" H  
(21.6 x 7 cm)

**SSB300** 76 oz. (2.2 L)  
9 7/8" Dia. x 3" H  
(25.1 x 7.6 cm)

**SSB400** 100 oz. (3 L)  
10 3/4" Dia. x 3 1/4" H  
(27.3 x 8.3 cm)

**SSB500** 128 oz. (3.8 L)  
11 1/2" Dia. x 3 3/4" H  
(29.2 x 9.5 cm)

**SSB800** 179 oz. (5.3 L)  
13 1/2" Dia. x 4 1/4" H  
(34.3 x 10.8 cm)

**SSB1300** 354 oz. (10.5 L)  
16 1/4" Dia. x 4 7/8" H  
(41.3 x 12.4 cm)

**SSB1600** 512 oz. (15.1 L)  
18 1/2" Dia. x 5 3/4" H  
(47 x 14.6 cm)

**SSB2000** 596 oz. (17.6 L)  
19" Dia. x 6" H  
(48.3 x 15.2 cm)

From top to bottom:

- SSB150
- SSB200
- SSB300
- SSB400
- SSB500
- SSB800
- SSB1300
- SSB1600
- SSB2000



### Round Woven Woodenware Bowl 🔥

Traditional material and design add up to a classic style your customers will want to share.

**RWW8** 26 oz. (0.77 L)  
8" Dia. x 2" H  
(20.3 x 5.1 cm)



## Pans and Cutters

### Angel Food Cake Pan

Heavy-duty 14-gauge pan. 1.5 mm hard aluminum with satin anodized finish.

**AFP958** 4 qt. (3.8 L)  
10" OD x 4" Deep x 4 1/4" Cone  
(25.4 x 10.2 x 10.8 cm)

### Doughnut Cutter

One-piece 16-gauge cutter. 1.25 mm satin anodized aluminum.

**13001** 3" Dia. x 2 1/2" H (7.6 x 6.4 cm)

### Biscuit Cutter

One-piece 16-gauge cutter. 1.25 mm satin anodized aluminum.

**13005** 3" Dia. x 2 1/2" H (7.6 x 6.4 cm)

## Stainless Steel Cake Rings

0.036" (0.9 mm) heavy-duty 20-gauge rings ensure uniform treats.

**SR6063** 6" Dia. X 3" H  
(15.2 x 7.6 cm)

**SR6073** 7" Dia. X 3" H  
(17.8 x 7.6 cm) (not shown)

**SR6083** 8" Dia. X 3" H  
(20.3 x 7.6 cm) (not shown)

**SR6093** 9" Dia. X 3" H  
(22.9 x 7.6 cm) (not shown)

**SR6103** 10" Dia. X 3" H  
(22.9 x 7.6 cm) (not shown)

## Springform Pan

This carbon steel, non-stick springform pan features a durable buckle and removable bottom for creating impressively shaped cakes.

**TSFP10** 10 1/4" Dia. x 2 5/8" H  
(26 x 6.7 cm)



SR6063



TSFP10

DURABLE BUCKLE





USA

A80012

### Straight-Sided Aluminum Cake Pan Sets

Available in 2" and 3" depths and heavy-weight aluminum options, these cake pans provide the needed sizes for your cake creations.

- A80012** 2" Deep 18-ga., 1 mm  
Set includes (1) Each 6", 8", 10", 12", 14" and 16" (15.2, 20.3, 25.4, 30.5, 35.6 and 40.6 x 5.1 cm)
- HA80012** 2" Deep 14-ga., 1.5 mm  
Set includes (1) Each 6", 8", 10", 12", 14" and 16" (15.2, 20.3, 25.4, 30.5, 35.6 and 40.6 x 5.1 cm) (not shown)
- 3801** 3" Deep 14-ga., 1.5 mm  
Set includes (1) Each 6", 8", 10", 12" and 14" (15.2, 20.3, 25.4, 30.5 and 35.6 x 7.6 cm) (not shown)

### Round Aluminum Cake Pans

Heavy-weight 14-ga., 1.5 mm aluminum, 3" Deep.

- 3806** 6" ID x 3" Deep (15.2 x 7.6 cm)
- 3807** 7" ID x 3" Deep (17.8 x 7.6 cm)
- 3808** 8" ID x 3" Deep (20.3 x 7.6 cm)
- 3809** 9" ID x 3" Deep (22.9 x 7.6 cm)
- 3810** 10" ID x 3" Deep (25.4 x 7.6 cm)
- 3812** 12" ID x 3" Deep (30.5 x 7.6 cm)
- 3813** 13" ID x 3" Deep (33 x 7.6 cm)
- 3814** 14" ID x 3" Deep (35.6 x 7.6 cm)



STRAIGHT-SIDED  
EDGES CREATE  
SMOOTH CAKE EDGES





TAPERED EDGES CREATE THE PERFECT CRUST

HOT USA



**Deep-Dish Aluminum Pie Pans**

Standard-weight 18-ga., 1 mm aluminum.

- 801** 7" Top ID x 8" Top OD x 5 1/2" Bottom ID x 1 1/8" Deep (17.8 x 20.3 x 14 x 2.9 cm)
- 897** 8" Top ID x 9" Top OD x 6 1/4" Bottom ID x 1 3/8" Deep (20.3 x 22.9 x 15.9 x 3 cm)
- 1188** 9" Top ID x 10" Top OD x 7 3/4" Bottom ID x 1 1/4" Deep (22.9 x 25.4 x 19.7 x 3.2 cm)
- 998** 9" Top ID x 10 1/8" Top OD x 7 5/8" Bottom ID x 1 1/4" Deep (22.9 x 25.7 x 19.4 x 3.2 cm) (not shown)
- 989** 9 1/8" Top ID x 9 7/8" Top OD x 7 3/8" Bottom ID x 1 1/8" Deep (23.2 x 25.1 x 18.7 x 2.9 cm) (not shown)
- 1190** 10" Top ID x 11 1/8" Top OD x 8 1/4" Bottom ID x 1 5/16" Deep (25.4 x 28.3 x 21 x 3.3 cm)
- 1200** 10 7/8" Top ID x 11 7/8" Top OD x 9 1/8" Bottom ID x 1 1/4" Deep (27.6 x 30.2 x 23.2 x 3.2 cm)

**Standard Aluminum Pie Pans**

Standard-weight 18-ga., 1 mm aluminum.

- 475** 4" Top ID x 4 3/8" Top OD x 3" Bottom ID x 1" Deep (10.2 x 11.1 x 7.6 x 2.5 cm)
- 744** 6" Top ID x 7" Top OD x 5 1/2" Bottom ID x 5/8" Deep (15.2 x 17.8 x 14 x 1.6 cm)
- 918** 7 7/8" Top ID x 9 1/8" Top OD x 6 7/8" Bottom ID x 1" Deep (20 x 23.2 x 17.5 x 2.5 cm)
- 1187** 9" Top ID x 10 1/8" Top OD x 8 1/8" Bottom ID x 3/4" Deep (22.9 x 25.7 x 20.6 x 1.9 cm)
- 1300** 11 7/8" Top ID x 13" Top OD x 10 7/8" Bottom ID x 7/8" Deep (30.2 x 33 x 27.6 x 2.2 cm)
- 1600** 15" Top ID x 16" Top OD x 13 3/4" Bottom ID x 7/8" Deep (38.1 x 45.6 x 34.9 x 2.2 cm)





FOR STRAINER FUNNELS, REFER  
TO PG. 376 IN BAR SUPPLIES



## Spun Aluminum Funnels

One-piece spun aluminum in your choice of sizes and weights.

### 1 mm, 18-gauge Aluminum

- 363** ½ Pint (236 mL)  
3 7/8" Dia. Funnel x 3 5/8" H  
x 5/8" Dia. Neck (9.8 x 9.2 x 1.6 cm)
- 524** 1 Pint (473 mL)  
5 1/4" Dia. Funnel x 5 1/4" H  
x 1 1/16" Dia. Neck (13.3 x 13.3 x 1.8 cm)

### 1.25 mm, 16-gauge Aluminum

- 699** 1 qt. (0.95 L)  
7" Dia. Funnel x 6 5/8" H  
x 3/4" Dia. Neck (17.8 x 16.8 x 1.9 cm)
- 913** 2 qt. (1.9 L)  
9 1/8" Dia. Funnel x 7 3/4" H  
x 1 1/16" Dia. Neck (23.2 x 19.7 x 1.8 cm)

### 1.5 mm, 14-gauge Aluminum, Heavy-Duty

- 1004** 4 qt. (3.8 L)  
8 3/4" Dia. x 8" H  
x 3" Dia. Neck (22.2 x 20.3 x 7.6 cm)

## Check Spindles

Keep used checks in one spot with these classic, retro spindles featuring your choice of metallic plating.

- GCS37** Brass-Plated  
3" Dia. x 6" H (7.6 x 15.2 cm)
- NCS36** Nickel-Plated  
3" Dia. x 6" H (7.6 x 15.2 cm)

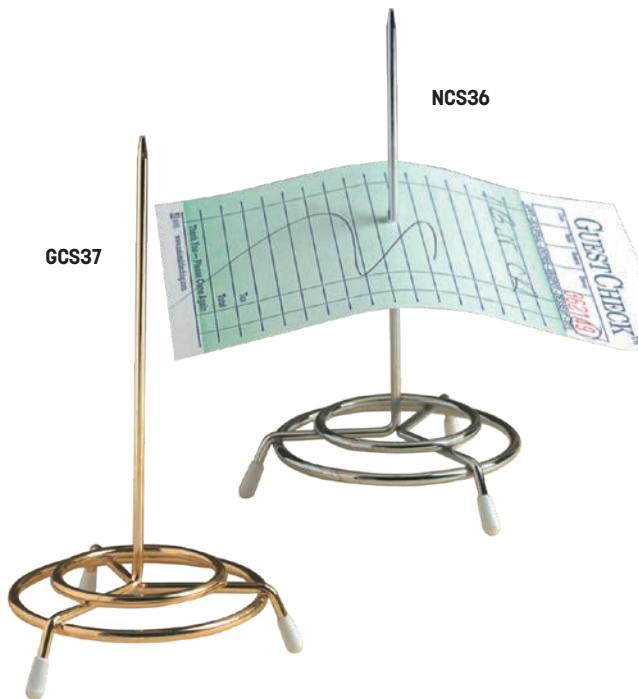

## Sandwich Spreader

With a stainless steel blade and wooden handle, this tool is elegantly simple.

- SPR725** 7 3/4" L (19.7 cm)



## Call Bell

A real humdinger in nickel-plated stainless steel with a black base.

- CB338** 3 3/8" Dia. (8.6 cm)





### Short-Height Stainless Steel Ticket Racks

Specifically engineered for modern restaurant needs, these stainless steel ticket racks are the perfect height for most restaurant spaces.

**TRSH12** 12" L x 1 1/8" H (30.5 x 2.9 cm)

**TRSH18** 18" L x 1 1/8" H (45.7 x 2.9 cm)

**TRSH24** 24" L x 1 1/8" H (61 x 2.9 cm)

### Stainless Steel Ticket Racks

Marbles inside the groove keep tickets in place. Plastic end caps with screws hold the marbles in.

**TR18** 18" L x 3 1/2" H (45.7 x 8.9 cm)

**TR24** 24" L x 3 1/2" H (61 x 8.9 cm)

**TR30** 30" L x 3 1/2" H (76.2 x 8.9 cm)

**TR36** 36" L x 3 1/2" H (91.4 x 8.9 cm)

**TR48** 48" L x 3 1/2" H (121.9 x 8.9 cm)

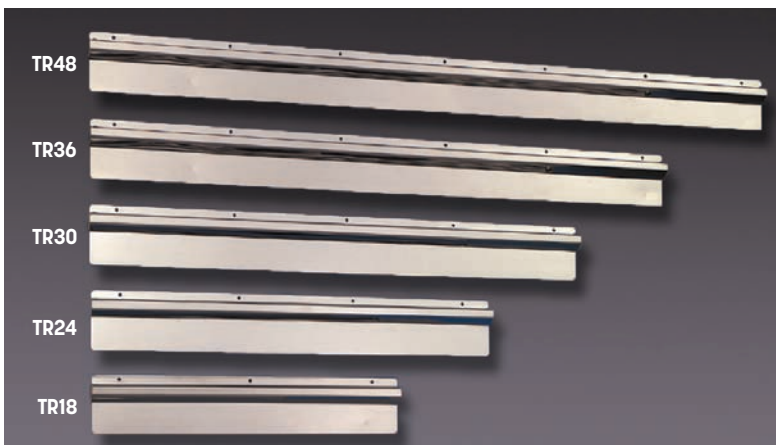

### Aluminum Ticket Racks

Marbles inside hold tickets securely. Attaches easily to walls and racks.

**AOR18** 18" L x 2 1/2" H (45.7 x 6.4 cm) (not shown)

**AOR24** 24" L x 2 1/2" H (61 x 6.4 cm) (not shown)

**AOR36** 36" L x 2 1/2" H (91.4 x 6.4 cm)

**AOR48** 48" L x 2 1/2" H (121.9 x 6.4 cm) (not shown)







### GRILL OR BASTING COVERS WITH BAKELITE KNOBS

Economical basting covers with black Bakelite knobs. Full 2" (5.1 cm) clearance over grill. Ships unassembled with knobs protected in a polybag.

#### Round Stainless Steel Basting Covers HOT

- BA640S** 6 1/2" Dia. x 2" H (16.5 x 5.1 cm)
- BA740S** 7 1/2" Dia. x 2" H (19.1 x 5.1 cm)
- BA840S** 8 3/8" Dia. x 2" H (21.3 x 5.1 cm)
- BA940S** 9 1/4" Dia. x 2" H (23.5 x 5.1 cm)
- BA1040S** 10 1/2" Dia. x 2 1/8" H (26.7 x 5.4 cm)
- BAKNOB** Extra Knob  
Minimum Order 12 Pieces



#### Round Aluminum Basting Covers HOT USA

- BA640A** 6" Dia. x 2" H (15.3 x 5.1 cm)
- BA740A** 7" Dia. x 2" H (17.8 x 5.1 cm)
- BA840A** 8" Dia. x 2" H (20.3 x 5.1 cm)
- BA940A** 9" Dia. x 2" H (22.9 x 5.1 cm)
- BA1040A** 10" Dia. x 2" H (25.4 x 5.1 cm)
- BAKNOB** Extra Knob  
Minimum Order 12 Pieces



#### Square Aluminum Basting Covers USA

- BASQ620** 6" Sq. x 2" H (15.2 x 5.1 cm)
- BASQ820** 8" Sq. x 2" H (20.3 x 5.1 cm)
- BASQ1020** 10" Sq. x 2" H (25.4 x 5.1 cm)
- BAKNOB** Extra Knob  
Minimum Order 12 Pieces

# Pizza Pans & Supplies





# A Guide to our Pizza Pans

## Aluminum Pans

Aluminum is an excellent conductor of heat, providing evenly baked crusts.

Standard-weight pans (denoted with "A" at the beginning of the item number) are made from 18-ga., 0.040", 1 mm aluminum.

Heavy-weight pans (denoted with "HA" at the beginning of the item number) are made from 14-ga., 0.064", 1.5 mm aluminum and are 50% heavier than standard-weight.

- Hand washing with aluminum-safe detergent is recommended.
- Through repeated use, pans will soften and, if scoured, will thin.

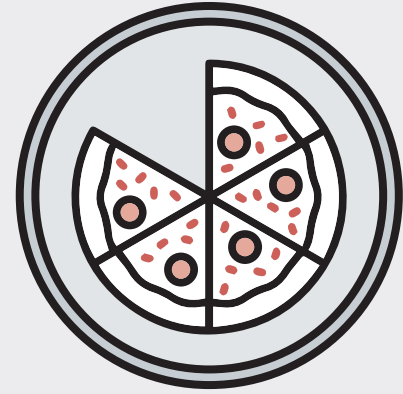

ALUMINUM (A/HA)

## Tin Plate Pans

Tin plate is a heavy-weight metal that will darken over time, providing even, efficient cooking.

Tin plate pans (denoted with "T" at the beginning or end of the item number) should be seasoned before use and may need periodic re-seasoning.

- Will darken with use and rust if refrigerated, soaked in water or left unseasoned in damp environments.
- Hand wash and wipe-dry immediately.
- Call for additional tin plate pan options.

### How to Season

*To season, wash in warm, soapy water and quickly dry. Brush oil on inside and outside surfaces of the pan and bake to a golden or dark brown. When seasoning, bake at regular times and temperatures. Some pans may need a second or third coating before being fully seasoned.*

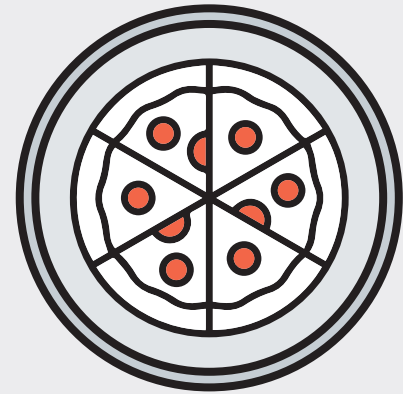

TIN PLATE (T)

## Hard Coat Anodized Pans

Heavy-weight and efficient, hard coat aluminum provides quick and efficient results.

Hard coat pans (denoted with "HC" at the beginning or end of the item number) are anodized with a synergistic electro-chemical process that converts the surface of aluminum into a dark aluminum oxide.

- Made from heavy-weight aluminum unless perforated, in which case they're made from standard-weight aluminum.
- Through repeated use, pans will soften and, if scoured, will thin.
- Season before use and hand wash with aluminum-safe detergent.

### How to Season

*Wash and dry the pan thoroughly. Wipe oil on the inside and outside surfaces of the pan and allow to soak in for 30 minutes. Then bake at regular cooking times and temperatures. Do not overbake and do not wash off excess oil. The oil residue and any additional oil added before baking allows the pan to develop non-stick properties. Remember when cleaning hard anodized aluminum, this is considered an amphoteric coating and will be attacked by solutions of a high-alkaline or acidic nature. Do not expose these pans to dishwashers or caustic cleaning solutions. Hand wash with detergents made specifically for aluminum.*

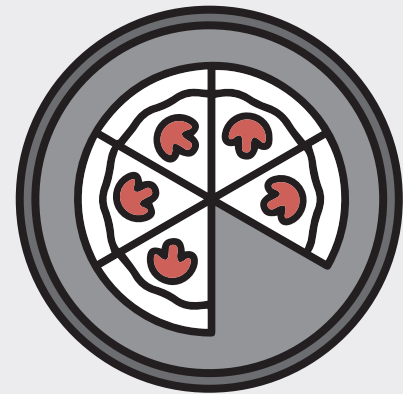

HARD COAT ANODIZED (HC)

## USA Proudly Manufactured in the United States of America

For over 75 years American Metalcraft has been producing pizza pans and trays in our facility located right outside of Chicago, Illinois. We are proud to still manufacture American-made quality products by employing local workers. When you see this symbol , rest assured the product is made in America.

We carry thousands of different pizza trays in varying styles, depths, materials and other options, resulting in tens of thousands of possible combinations. Because each pan is made to order, it's possible that yours is the first of its kind. Special-order pans cannot be cancelled or returned, so please review and re-confirm your order. If you have any questions, give us a call and, if necessary, request a sample.

## Nibs (N)

Nibs raise the pizza off of the baking surface, allowing moisture to escape providing a fresher, crispier pizza.

minimum  
order  
24 pieces

- Nibs are approximately 5/8" (15.9 mm) in diameter and raise the pizza about 1/8" (3.2 mm) above the surface of the pan.
- Any round or square pizza trays or pans measuring 2" (5.1 cm) deep or less, or between 8" (20.3 cm) and 20" (50.8 cm), can be made with nibs.
- Pans with nibs cannot be perforated.
- To order, add "N" to the beginning of the regular item number and note in the body of the order that the pans should be made with nibs.
- Refer to price list or amnow.com for pricing information.

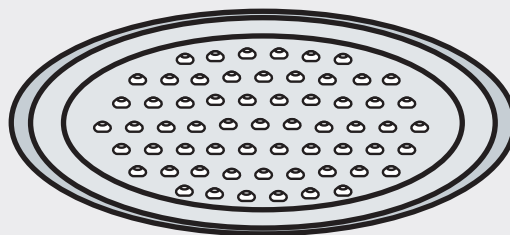

## Perf (P)

Perforated pans allow the bottom of the pizza to cook faster and can provide a crispier crust. They can also keep cooked pizzas fresher by allowing moisture to escape.

- Holes are 3/8" (9.5 mm) in diameter.
- Round or square pizza trays or pans less than 21" (53.3 cm) in diameter can be perforated.
- Perf pans cannot be made with nibs.
- To order, add "P" to the beginning or end of the regular item number and note in the body of the order that the pans should be perforated.
- Refer to price list or amnow.com for pricing information.

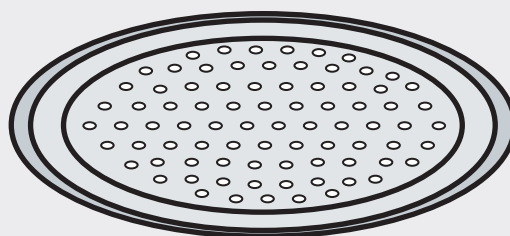

## SuperPerf (SP)

SuperPerf pans have twice as many holes as Perf pans, allowing the bottom of the pizza to cook faster and providing a crispier crust. They can also keep cooked pizzas fresher by allowing moisture to escape.

- Holes are 3/8" (9.5 mm) in diameter.
- Round pans less than 21" (53.3 cm) in diameter can be SuperPerf.
- SuperPerf pans cannot be made with nibs.
- To order, add "SP" to the end of the regular item number and note in the body of the order that the pans should be SuperPerf.
- Refer to price list or amnow.com for pricing information.

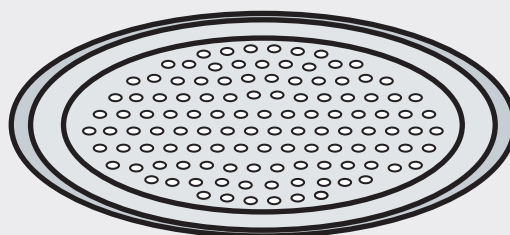

### Perf and SuperPerf Hole Guide

For pans with a maximum bottom inside diameter of:		Number of Holes Standard Perf	Number of Holes Super Perf	For pans with a maximum bottom inside diameter of:		Number of Holes Standard Perf	Number of Holes Super Perf
5"	(12.7 cm)	10	20	14"	(35.6 cm)	185	370
6"	(15.2 cm)	21	42	15"	(38.1 cm)	185	370
7"	(17.8 cm)	36	72	16"	(40.6 cm)	228	456
8"	(20.3 cm)	57	114	17"	(43.2 cm)	275	550
9"	(22.9 cm)	57	114	18"	(45.7 cm)	275	550
10"	(25.4 cm)	82	164	19"	(48.3 cm)	326	652
11"	(27.9 cm)	113	226	20"	(50.8 cm)	379	758
12"	(30.5 cm)	113	226	21"	(53.3 cm)	379	758
13"	(33.0 cm)	146	292				

**Perf P** Perforating Pans  
**SuperPerf SP** Double the Holes  
**Nibs N** Raised Nibs or Bumps

*This box is used throughout the Pizza Tray section to denote what options are available for each series. Please note that these options are made to order and may or may not be in stock. For pricing, visit amnow.com*





**Pizza Screens**  

Screens allow for more air circulation than conventional pans, creating a more evenly baked crust.

**Round Heavy-Duty Aluminum**

- 18706 6" OD (15.2 cm)
- 18707 7" OD (17.8 cm)
- 18708 8" OD (20.3 cm)
- 18709 9" OD (22.9 cm)
- 18710 10" OD (25.4 cm)
- 18711 11" OD (27.9 cm)
- 18712 12" OD (30.5 cm)
- 18713 13" OD (33 cm)
- 18714 14" OD (35.6 cm)
- 18715 15" OD (38.1 cm)
- 18716 16" OD (40.6 cm)
- 18717 17" OD (43.2 cm)
- 18718 18" OD (45.7 cm)
- 18719 19" OD (48.3 cm)
- 18720 20" OD (50.8 cm)
- 18724\* 24" OD (61 cm)
- 18728\* 28" OD (71.1 cm)

**Rectangular Heavy-Duty Aluminum**

- 18731\* 11" L x 16" W (27.9 x 40.6 cm)  
Fits half-size bun pan
- 18744\* 16" L x 24" W (40.6 x 61 cm)  
Fits full-size bun pan

**Pizza Screen Rack** 

Inspired by our popular pizza racks on pg. 440, this piece holds up to 96 of our screens. Constructed from 3/16" (0.5 cm) chrome-plated steel rods.

- 18040 14" L x 9" W x 10 1/2" H  
(35.6 x 22.9 x 26.7 cm)



\* Not available in seamless construction



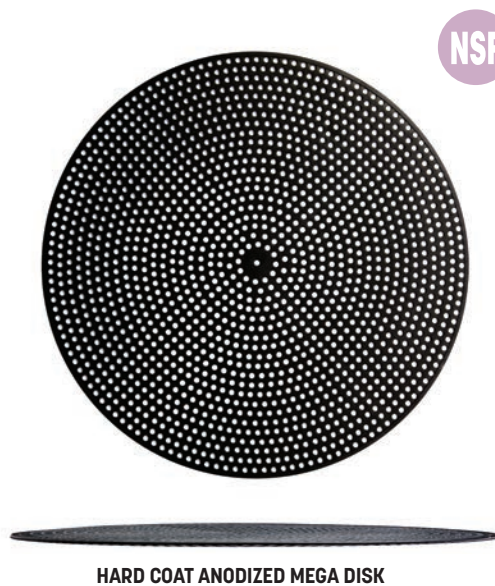
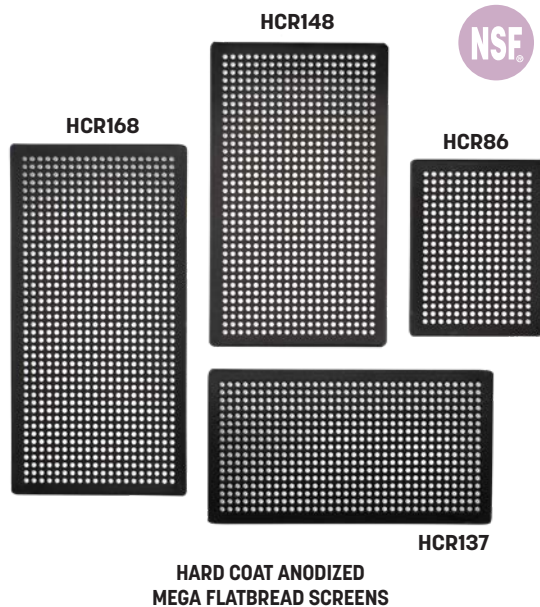

## Mega Flatbread Screens - Hard Coat Anodized Aluminum

Why should round pizzas have all the fun? The durability and efficient-baking engineering of our Mega Screens meets a silhouette designed specifically for flatbreads. Features  $\frac{3}{32}$ " (0.2 cm) Mega perforations.

### Pan Size

8" L x 6  $\frac{1}{8}$ " W (20.3 x 15.6 cm)  
 13" L x 7  $\frac{1}{8}$ " W (33 x 18.1 cm)  
 14" L x 8" W (35.6 x 20.3 cm)  
 16" L x 8" W (40.6 x 20.3 cm)

### Hard Coat Anodized Aluminum

HCR86  
 HCR137  
 HCR148  
 HCR168

## Mega Disks - Hard Coat Anodized Aluminum

Designed for durable and efficient baking, Mega Disks provide the maximum airflow to cook dough quickly and evenly. Lasts 5-10 times longer than normal screens. Features  $\frac{3}{32}$ " (0.2 cm) Mega perforations.

### Pan Size

10" Dia. (25.4 cm)  
 12" Dia. (30.5 cm)  
 14" Dia. (35.6 cm)  
 16" Dia. (40.6 cm)  
 18" Dia. (45.7 cm)

### Hard Coat Anodized Aluminum

HCAD10  
 HCAD12  
 HCAD14  
 HCAD16  
 HCAD18

## Mega Screens - Aluminum

Mega Screens are the smart choice for those looking for a more durable screen option. Holes and open rims make cleaning a breeze and improve food safety. Available in aluminum or hard coat anodized aluminum, Mega Screens can last 5 to 10 times longer than standard pizza screens. Hard Coat Mega Screens are the most durable, cost-effective screens for conveyor oven use. Holes are  $\frac{3}{32}$ " (0.2 cm) in diameter.

### Pan Size

10" ID x 10  $\frac{3}{4}$ " OD (25.4 x 27.3 cm)  
 11" ID x 11  $\frac{3}{4}$ " OD (27.9 x 29.8 cm)  
 12" ID x 12  $\frac{3}{4}$ " OD (30.5 x 32.4 cm)  
 13" ID x 13  $\frac{3}{4}$ " OD (33.0 x 34.9 cm)  
 14" ID x 14  $\frac{3}{4}$ " OD (35.6 x 37.5 cm)  
 15" ID x 15  $\frac{3}{4}$ " OD (38.1 x 40 cm)  
 16" ID x 16  $\frac{3}{4}$ " OD (40.6 x 42.5 cm)  
 17" ID x 17  $\frac{3}{4}$ " OD (43.2 x 45.1 cm)  
 18" ID x 18  $\frac{3}{4}$ " OD (45.7 x 47.6 cm)

### Aluminum

28710  
 28711  
 28712  
 28713  
 28714  
 28715  
 28716  
 28717  
 28718

### Hard Coat Anodized Aluminum

HC28710  
 HC28711  
 HC28712  
 HC28713  
 HC28714  
 HC28715  
 HC28716  
 HC28717  
 HC28718

Refer to pg. 458-459  
for care and use  
instructions.



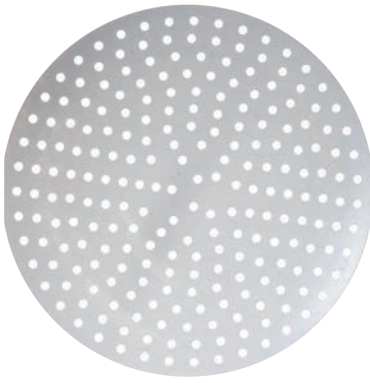

**P**  
Perf aluminum disk

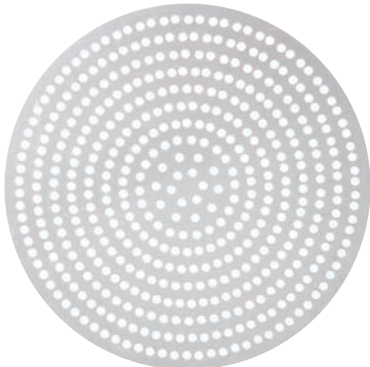

**SP**  
SuperPerf aluminum disk

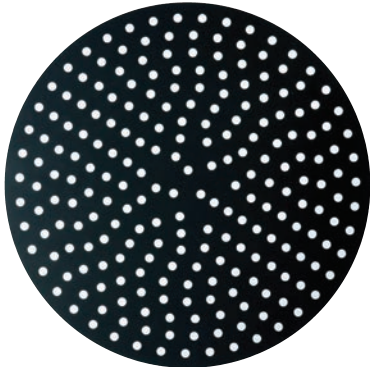

**PHC**  
Perf hard coat anodized disk

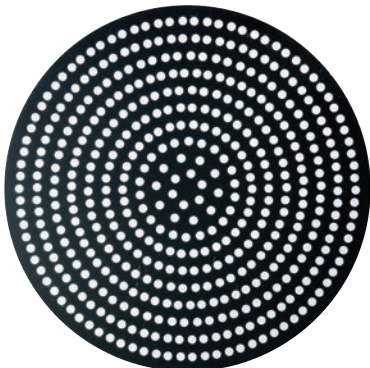

**SPHC**  
SuperPerf hard coat anodized disk

## Perf Disks - Aluminum

Manufactured from 18-ga. 1 mm aluminum, these perforated disks produce a more evenly baked crust by allowing for more air circulation. Holes measure  $\frac{3}{8}$ " (9.5 mm) in diameter.

### Pan Size

7 1/2" Dia. (19.1 cm)	36 Holes
8" Dia. (20.3 cm)	57 Holes
9" Dia. (22.9 cm)	57 Holes
10" Dia. (25.4 cm)	82 Holes
11" Dia. (27.9 cm)	113 Holes
12" Dia. (30.5 cm)	113 Holes
13" Dia. (33 cm)	146 Holes
14" Dia. (35.6 cm)	185 Holes
15" Dia. (38.1 cm)	185 Holes
16" Dia. (40.6 cm)	228 Holes
17" Dia. (43.2 cm)	275 Holes
18" Dia. (45.7 cm)	275 Holes
19" Dia. (48.3 cm)	326 Holes
20" Dia. (50.8 cm)	379 Holes

### Aluminum

<b>18907P</b>
<b>18908P</b>
<b>18909P</b>
<b>18910P</b>
<b>18911P</b>
<b>18912P</b>
<b>18913P</b>
<b>18914P</b>
<b>18915P</b>
<b>18916P</b>
<b>18917P</b>
<b>18918P</b>
<b>18919P</b>
<b>18920P</b>

### Hard Coat Anodized Aluminum

<b>18907PHC</b>
<b>18908PHC</b>
<b>18909PHC</b>
<b>18910PHC</b>
<b>18911PHC</b>
<b>18912PHC</b>
<b>18913PHC</b>
<b>18914PHC</b>
<b>18915PHC</b>
<b>18916PHC</b>
<b>18917PHC</b>
<b>18918PHC</b>
<b>18919PHC</b>
<b>18920PHC</b>

## SuperPerf Disks - Aluminum

### Pan Size

7 1/2" Dia. (19.1 cm)	72 Holes
8" Dia. (20.3 cm)	114 Holes
9" Dia. (22.9 cm)	114 Holes
10" Dia. (25.4 cm)	164 Holes
11" Dia. (27.9 cm)	226 Holes
12" Dia. (30.5 cm)	226 Holes
13" Dia. (33 cm)	292 Holes
14" Dia. (35.6 cm)	370 Holes
15" Dia. (38.1 cm)	370 Holes
16" Dia. (40.6 cm)	456 Holes
17" Dia. (43.2 cm)	550 Holes
18" Dia. (45.7 cm)	550 Holes
19" Dia. (48.3 cm)	652 Holes
20" Dia. (50.8 cm)	758 Holes

### Aluminum

<b>18907SP</b>
<b>18908SP</b>
<b>18909SP</b>
<b>18910SP</b>
<b>18911SP</b>
<b>18912SP</b>
<b>18913SP</b>
<b>18914SP</b>
<b>18915SP</b>
<b>18916SP</b>
<b>18917SP</b>
<b>18918SP</b>
<b>18919SP</b>
<b>18920SP</b>

### Hard Coat Anodized Aluminum

<b>18907SPHC</b>
<b>18908SPHC</b>
<b>18909SPHC</b>
<b>18910SPHC</b>
<b>18911SPHC</b>
<b>18912SPHC</b>
<b>18913SPHC</b>
<b>18914SPHC</b>
<b>18915SPHC</b>
<b>18916SPHC</b>
<b>18917SPHC</b>
<b>18918SPHC</b>
<b>18919SPHC</b>
<b>18920SPHC</b>

SUPERPERF DISKS FEATURE TWICE AS MANY HOLES AS PERF DISKS



**CAR PANS**

Heavy-weight 14-ga., 1.5 mm aluminum



**CAR HC PANS**

Hard coat anodized 14-ga., 1.5 mm aluminum



SHARP EDGE ALSO CUTS DOUGH

**CAR Pans - Tapered/Nesting**

The edges of these pans are left unfinished so that they're sharp enough to cut dough. Just place a sheet of dough over the pan and use a rolling pin or pie roller to cut it down to size.

**PAN DEPTH 5/8" (1.6 CM)**

Pan Size

- 6" Top OD x 5" Bottom ID (15.2 x 12.7 cm)
- 7" Top OD x 6" Bottom ID (17.8 x 15.2 cm)
- 7 3/4" Top OD x 6 3/4" Bottom ID (19.7 x 17.1 cm)
- 8 1/2" Top OD x 7 1/2" Bottom ID (21.6 x 19.1 cm)

**Heavy-Weight**

14-ga., 1.5 mm Aluminum

- CAR6
- CAR7
- CAR8
- CAR9

**Hard Coat Anodized**

14-ga., 1.5 mm Aluminum

- CAR6HC
- CAR7HC
- CAR8HC
- CAR9HC

**PAN DEPTH 11/16" (1.7 CM)**

Pan Size

- 9" Top OD x 8" Bottom ID (22.9 x 20.3 cm)
- 10" Top OD x 9" Bottom ID (25.4 x 22.9 cm)
- 11" Top OD x 10" Bottom ID (27.9 x 25.4 cm)
- 12" Top OD x 11" Bottom ID (30.5 x 27.9 cm)
- 13" Top OD x 12" Bottom ID (33 x 30.5 cm)
- 14" Top OD x 13" Bottom ID (35.6 x 33 cm)
- 15" Top OD x 14" Bottom ID (38.1 x 35.6 cm)
- 16" Top OD x 15" Bottom ID (40.6 x 38.1 cm)
- 17" Top OD x 16" Bottom ID (43.2 x 40.6 cm)
- 18" Top OD x 17" Bottom ID (45.7 x 43.2 cm)
- 19" Top OD x 18" Bottom ID (48.3 x 45.7 cm)
- 20" Top OD x 19" Bottom ID (50.8 x 48.3 cm)
- 21" Top OD x 20" Bottom ID (53.3 x 50.8 cm)

- CAR95
- CAR10
- CAR11
- CAR12
- CAR13
- CAR14
- CAR15
- CAR16
- CAR17
- CAR18
- CAR19
- CAR20
- CAR21

- CAR95HC
- CAR10HC
- CAR11HC
- CAR12HC
- CAR13HC
- CAR14HC
- CAR15HC
- CAR16HC
- CAR17HC
- CAR18HC
- CAR19HC
- CAR20HC
- CAR21HC



**HOT**



**HATP**  
Heavy-weight  
14-ga., 1.5 mm  
aluminum

HEAVY-DUTY ALUMINUM  
ADDS TO LONGER LIFE

**TP**  
Standard-weight  
18-ga., 1 mm aluminum

**HCTP**  
Hard coat anodized  
14-ga., 1.5 mm aluminum

**TP Series Wide-Rim Pans** HOT USA

There's a reason that the pizza industry has trusted American Metalcraft since 1947. Often imitated, but never duplicated, our signature TP Series of serving trays offers unbeatable reliability and durability, thanks to heavy-duty 14 and 18-ga. aluminum construction.

<b>Pan Size</b>	<b>TP Standard-Weight 18-ga., 1 mm Aluminum</b>	<b>HATP Heavy-Weight 14-ga., 1.5 mm Aluminum</b> <span style="background-color: #00a08a; border-radius: 50%; padding: 2px;">USA</span>	<b>HCTP Hard Coat Anodized 14-ga., 1.5 mm Aluminum</b> <span style="background-color: #00a08a; border-radius: 50%; padding: 2px;">USA</span>
6" OD x 4 1/2" ID (15.2 x 11.4 cm)	<b>TP6</b>	<b>HATP6</b>	<b>HCTP6</b>
7" OD x 5 1/2" ID (17.9 x 14 cm)	<b>TP7</b>	<b>HATP7</b>	<b>HCTP7</b>
8" OD x 6" ID (20.3 x 15.2 cm)	<b>TP8</b>	<b>HATP8</b>	<b>HCTP8</b>
9" OD x 7" ID (22.9 x 17.9 cm)	<b>TP9</b>	<b>HATP9</b>	<b>HCTP9</b>
10" OD x 8" ID (25.4 x 20.3 cm)	<b>TP10</b>	<b>HATP10</b>	<b>HCTP10</b>
11" OD x 9" ID (27.9 x 22.9 cm)	<b>TP11</b>	<b>HATP11</b>	<b>HCTP11</b>
12" OD x 10" ID (30.5 x 25.4 cm)	<b>TP12</b>	<b>HATP12</b>	<b>HCTP12</b>
13" OD x 11" ID (33 x 27.9 cm)	<b>TP13</b>	<b>HATP13</b>	<b>HCTP13</b>
14" OD x 12" ID (35.6 x 30.5 cm)	<b>TP14</b>	<b>HATP14</b>	<b>HCTP14</b>
15" OD x 13" ID (38.1 x 33 cm)	<b>TP15</b>	<b>HATP15</b>	<b>HCTP15</b>
16" OD x 14" ID (40.6 x 35.6 cm)	<b>TP16</b>	<b>HATP16</b>	<b>HCTP16</b>
17" OD x 15" ID (43.2 x 38.1 cm)	<b>TP17</b>	<b>HATP17</b>	<b>HCTP17</b>
18" OD x 16" ID (45.7 x 40.6 cm)	<b>TP18</b>	<b>HATP18</b>	<b>HCTP18</b>
19" OD x 17" ID (48.3 x 43.2 cm)	<b>TP19</b>	<b>HATP19</b>	<b>HCTP19</b>
20" OD x 18" ID (50.8 x 45.7 cm)	<b>TP20</b>	<b>HATP20</b>	<b>HCTP20</b>
21" OD x 19" ID (53.3 x 48.3 cm)		<b>HATP21</b>	
22" OD x 20" ID (55.9 x 50.8 cm)		<b>HATP22</b>	
23" OD x 21" ID (58.4 x 53.3 cm)		<b>HATP23</b>	
24" OD x 22" ID (61 x 55.9 cm)		<b>HATP24</b>	
26" OD x 24" ID (66 x 61 cm)		<b>HATP26</b>	
28" OD x 26" ID (71.1 x 66 cm)		<b>HATP28</b>	

**Perf P** Perforating Pans  
**SuperPerf SP** Double the Holes  
**Nibs N** Raised Nibs or Bumps

Refer to pg. 458-459 for care and use instructions.  
For pricing, visit [amnow.com](http://amnow.com)



**HACTP**  
Heavy-weight  
14-ga., 1.5 mm  
aluminum

**CTP**  
Standard-weight  
18-ga., 1 mm aluminum

**HCCTP**  
Hard coat anodized  
14-ga., 1.5 mm aluminum

**CTP Series Coupe-Style Pans**

Just like our signature TP Series, these coupe-style pans are manufactured from the finest grade of aluminum. They'll last longer than your average pizza pan, making them a financially savvy choice to serve pizzas.

<u>Pan Size</u>	<u>CTP Standard-Weight 18-ga., 1 mm Aluminum</u>	<u>HACTP Heavy-Weight 14-ga., 1.5 mm Aluminum</u>	<u>HCCTP Hard Coat Anodized 14-ga., 1.5 mm Aluminum</u>
6" OD x 4 1/2" ID (15.2 x 11.4 cm)	<b>CTP6</b>	<b>HACTP6</b>	<b>HCCTP6</b>
7" OD x 5 1/2" ID (17.9 x 14 cm)	<b>CTP7</b>	<b>HACTP7</b>	<b>HCCTP7</b>
8" OD x 6" ID (20.3 x 15.2 cm)	<b>CTP8</b>	<b>HACTP8</b>	<b>HCCTP8</b>
9" OD x 7" ID (22.9 x 17.9 cm)	<b>CTP9</b>	<b>HACTP9</b>	<b>HCCTP9</b>
10" OD x 8" ID (25.4 x 20.3 cm)	<b>CTP10</b>	<b>HACTP10</b>	<b>HCCTP10</b>
11" OD x 9" ID (27.9 x 22.9 cm)	<b>CTP11</b>	<b>HACTP11</b>	<b>HCCTP11</b>
12" OD x 10" ID (30.5 x 25.4 cm)	<b>CTP12</b>	<b>HACTP12</b>	<b>HCCTP12</b>
13" OD x 11" ID (33 x 27.9 cm)	<b>CTP13</b>	<b>HACTP13</b>	<b>HCCTP13</b>
14" OD x 12" ID (35.6 x 30.5 cm)	<b>CTP14</b>	<b>HACTP14</b>	<b>HCCTP14</b>
15" OD x 13" ID (38.1 x 33 cm)	<b>CTP15</b>	<b>HACTP15</b>	<b>HCCTP15</b>
16" OD x 14" ID (40.6 x 35.6 cm)	<b>CTP16</b>	<b>HACTP16</b>	<b>HCCTP16</b>
17" OD x 15" ID (43.2 x 38.1 cm)	<b>CTP17</b>	<b>HACTP17</b>	<b>HCCTP17</b>
18" OD x 16" ID (45.7 x 40.6 cm)	<b>CTP18</b>	<b>HACTP18</b>	<b>HCCTP18</b>
19" OD x 17" ID (48.3 x 43.2 cm)	<b>CTP19</b>	<b>HACTP19</b>	<b>HCCTP19</b>
20" OD x 18" ID (50.8 x 45.7 cm)		<b>HACTP20</b>	<b>HCCTP20</b>
21" OD x 19" ID (53.3 x 48.3 cm)		<b>HACTP21</b>	
22" OD x 20" ID (55.9 x 50.8 cm)		<b>HACTP22</b>	
23" OD x 21" ID (58.4 x 53.3 cm)		<b>HACTP23</b>	
24" OD x 22" ID (61 x 55.9 cm)		<b>HACTP24</b>	
26" OD x 24" ID (66 x 61 cm)		<b>HACTP26</b>	
28" OD x 26" ID (71.1 x 66 cm)		<b>HACTP28</b>	

**Perf P** Perforating Pans  
**SuperPerf SP** Double the Holes  
**Nibs N** Raised Nibs or Bumps

Refer to pg. 458-459 for care and use instructions.  
For pricing, visit [amnow.com](http://amnow.com)





**A2000**  
Standard-weight  
18-ga., 1 mm aluminum

**HA2000**  
Heavy-weight  
14-ga., 1.5 mm aluminum



DESIGNED TO NEST FOR  
SPACE-SAVING STORAGE



**HC2000**  
Hard coat anodized  
14-ga., 1.5 mm aluminum

**2000 Series - Tapered/Nesting**

The 2000 series is bringing the heat! Available in multiple diameters and in a depth of 1/2" (1.3 cm), these pizza pans are perfect for baking hand-tossed, topping-loaded pizzas. Their high-quality, durable aluminum construction heats quickly and evenly, then easily nests to take up minimal storage space.

**PAN DEPTH 1/2" (1.3 CM)**

**Pan Size**

6" Top ID x 5 5/8" Bottom ID (15.2 x 14.3 cm)
7" Top ID x 6 5/8" Bottom ID (17.9 x 16.8 cm)
8" Top ID x 7 5/8" Bottom ID (20.3 x 19.4 cm)
9" Top ID x 8 5/8" Bottom ID (22.9 x 21.9 cm)
10" Top ID x 9 5/8" Bottom ID (25.4 x 24.4 cm)
11" Top ID x 10 5/8" Bottom ID (27.9 x 27 cm)
12" Top ID x 11 5/8" Bottom ID (30.5 x 29.5 cm)
13" Top ID x 12 5/8" Bottom ID (33 x 32.1 cm)
14" Top ID x 13 5/8" Bottom ID (35.6 x 34.6 cm)
15" Top ID x 14 5/8" Bottom ID (38.1 x 37.1 cm)
16" Top ID x 15 5/8" Bottom ID (40.6 x 39.7 cm)
17" Top ID x 16 5/8" Bottom ID (43.2 x 42.2 cm)
18" Top ID x 17 5/8" Bottom ID (45.7 x 44.8 cm)

**A2000 Standard-Weight  
18-ga., 1 mm Aluminum**

A2006
A2007
A2008
A2009
A2010
A2011
A2012
A2013
A2014
A2015
A2016
A2017
A2018

**HA2000 Heavy-Weight  
14-ga., 1.5 mm Aluminum**

HA2006
HA2007
HA2008
HA2009
HA2010
HA2011
HA2012
HA2013
HA2014
HA2015
HA2016
HA2017
HA2018

**HC2000 Hard Coat Anodized  
14-ga., 1.5 mm Aluminum**

HC2006
HC2007
HC2008
HC2009
HC2010
HC2011
HC2012
HC2013
HC2014
HC2015
HC2016
HC2017
HC2018

**Perf P** Perforating Pans  
**SuperPerf SP** Double the Holes  
**Nibs N** Raised Nibs or Bumps

**Covers** Separators and 7000 pans (pg. 415) can be used as covers  
**Stacking** 7000 pans (pg. 415) are stacking covers for tapered pans  
Refer to pg. 458-459 for care and use instructions. For pricing, visit [annow.com](http://annow.com)

**HADEP**  
Heavy-weight  
14-ga., 1.5 mm aluminum



**ADEP**  
Standard-weight  
18-ga., 1 mm aluminum



**HCDEP**  
Hard coat anodized  
14-ga., 1.5 mm aluminum

**DEP Series - Tapered/Nesting**

Bring on the deep dish with the DEP Series! Available in a depth of 1" (2.5 cm), these durable aluminum pizza pans are perfect for baking hearty deep dish pizzas. And with multiple diameters and finishes, you are sure to find the right pan to cook quickly and evenly, then nest conveniently for storage.

**PAN DEPTH 1" (2.5 CM)**

**Pan Size**

- 6" Top ID x 5 5/8" Bottom ID (15.2 x 14.3 cm)
- 7" Top ID x 6 5/8" Bottom ID (17.9 x 16.8 cm)
- 8" Top ID x 7 5/8" Bottom ID (20.3 x 19.4 cm)
- 9" Top ID x 8 5/8" Bottom ID (22.9 x 21.9 cm)
- 10" Top ID x 9 5/8" Bottom ID (25.4 x 24.4 cm)
- 11" Top ID x 10 5/8" Bottom ID (27.9 x 27 cm)
- 12" Top ID x 11 5/8" Bottom ID (30.5 x 29.5 cm)
- 13" Top ID x 12 5/8" Bottom ID (33 x 32.1 cm)
- 14" Top ID x 13 5/8" Bottom ID (35.6 x 34.6 cm)
- 15" Top ID x 14 5/8" Bottom ID (38.1 x 37.1 cm)
- 16" Top ID x 15 5/8" Bottom ID (40.6 x 39.7 cm)
- 17" Top ID x 16 5/8" Bottom ID (43.2 x 42.2 cm)
- 18" Top ID x 17 5/8" Bottom ID (45.7 x 44.8 cm)
- 19" Top ID x 18 1/4" Bottom ID (48.3 x 46.4 cm)

**ADEP Standard-Weight  
18-ga., 1 mm Aluminum**

- ADEP6
- ADEP7
- ADEP8
- ADEP9
- ADEP10
- ADEP11
- ADEP12
- ADEP13
- ADEP14
- ADEP15
- ADEP16
- ADEP17
- ADEP18

**HADEP Heavy-Weight  
14-ga., 1.5 mm Aluminum**

- HADEP6
- HADEP7
- HADEP8
- HADEP9
- HADEP10
- HADEP11
- HADEP12
- HADEP13
- HADEP14
- HADEP15
- HADEP16
- HADEP17
- HADEP18
- HADEP19

**HCDEP Hard Coat Anodized  
14-ga., 1.5 mm Aluminum**

- HCDEP6
- HCDEP7
- HCDEP8
- HCDEP9
- HCDEP10
- HCDEP11
- HCDEP12
- HCDEP13
- HCDEP14
- HCDEP15
- HCDEP16
- HCDEP17
- HCDEP18

**Perf P** Perforating Pans  
**SuperPerf SP** Double the Holes  
**Nibs N** Raised Nibs or Bumps

**Covers** Separators and 7000 pans (pg. 415) can be used as covers  
**Stacking** 7000 pans (pg. 415) are stacking covers for tapered pans  
Refer to pg. 458-459 for care and use instructions. For pricing, visit [amnow.com](http://amnow.com)





9000 Series Pan  
shown seasoned



**A9000**  
Standard-weight  
18-ga., 1 mm aluminum



**9000 SERIES - Tapered/Nesting** 

Impress customers with delicious deep dish pizzas. The 9000 series provides versatile height and diameter options, along with multiple material choices to create the perfect pizza. The result is efficiently and evenly cooked deep dish pizzas, with all of the fixings, each and every time. Pans are tapered to nest for space-saving storage.

**PAN DEPTH 1 1/8" (2.9 CM)**

**Pan Size**

- 5" Top ID x 4 3/8" Bottom ID (12.7 x 11.1 cm)
- 5 1/2" Top ID x 5" Bottom ID (13.9 x 12.7 cm)

**A9000 Standard-Weight  
18-ga., 1 mm Aluminum**

- A9005**
- A9006**

**PAN DEPTH 1 1/2" (3.8 CM)**

**Pan Size**

- 6" Top ID x 5 1/2" Bottom ID (15.2 x 14 cm)
- 7" Top ID x 6 1/4" Bottom ID (17.8 x 15.9 cm)
- 8" Top ID x 7 1/4" Bottom ID (20.3 x 18.4 cm)
- 9" Top ID x 8 1/4" Bottom ID (22.9 x 21 cm)
- 10" Top ID x 9 1/4" Bottom ID (25.4 x 23.5 cm)
- 11" Top ID x 10 1/4" Bottom ID (27.9 x 26 cm)
- 12" Top ID x 11 1/4" Bottom ID (30.5 x 28.6 cm)
- 13" Top ID x 12 1/4" Bottom ID (33 x 31.1 cm)
- 14" Top ID x 13 1/4" Bottom ID (35.6 x 33.7 cm)
- 15" Top ID x 14 1/4" Bottom ID (38.1 x 36.2 cm)
- 16" Top ID x 15 1/4" Bottom ID (40.6 x 38.7 cm)

- A90671.5**
- A90071.5**
- A90081.5**
- A90091.5**
- A90101.5**
- A90111.5**
- A90121.5**
- A90131.5**
- A90141.5**
- A90151.5**
- A90161.5**

**PAN DEPTH 2" (5.1 CM)**

**Pan Size**

- 6" Top ID x 5" Bottom ID (15.2 x 12.7 cm)
- 7" Top ID x 6" Bottom ID (17.8 x 15.2 cm)
- 8" Top ID x 7" Bottom ID (20.3 x 17.8 cm)
- 9" Top ID x 8" Bottom ID (22.9 x 20.3 cm)
- 10" Top ID x 9" Bottom ID (25.4 x 22.9 cm)
- 11" Top ID x 10" Bottom ID (27.9 x 25.4 cm)
- 12" Top ID x 11" Bottom ID (30.5 x 27.9 cm)
- 13" Top ID x 12" Bottom ID (33 x 30.5 cm)
- 14" Top ID x 13" Bottom ID (35.6 x 33 cm)
- 15" Top ID x 14" Bottom ID (38.1 x 35.6 cm)
- 16" Top ID x 15" Bottom ID (40.6 x 38.1 cm)

- A90672**
- A90072**
- A90082**
- A90092**
- A90102**
- A90112**
- A90122**
- A90132**
- A90142**
- A90152**
- A90162**

**HA9000**  
Heavy-weight  
14-ga., 1.5 mm  
aluminum



**HC9000**  
Hard coat anodized  
14-ga., 1.5 mm  
aluminum



USA

**9000 SERIES - Tapered/Nesting**

**PAN DEPTH 1 1/8" (2.9 CM)**

**Pan Size**

5" Top ID x 4 3/8" Bottom ID (12.7 x 11.1 cm)

5 1/2" Top ID x 5" Bottom ID (14 x 12.7 cm)

**HA9000 Heavy-Weight  
14-ga., 1.5 mm Aluminum**

HA9005

HA9006

**HC9000 Hard Coat Anodized  
14-ga., 1.5 mm Aluminum**

HC9005

HC9006

**PAN DEPTH 1 1/2" (3.8 CM)**

**Pan Size**

6" Top ID x 5 1/2" Bottom ID (15.2 x 14 cm)

7" Top ID x 6 1/4" Bottom ID (17.8 x 15.9 cm)

8" Top ID x 7 1/4" Bottom ID (20.3 x 18.4 cm)

9" Top ID x 8 1/4" Bottom ID (22.9 x 21 cm)

10" Top ID x 9 1/4" Bottom ID (25.4 x 23.5 cm)

11" Top ID x 10 1/4" Bottom ID (27.9 x 26 cm)

12" Top ID x 11 1/4" Bottom ID (30.5 x 28.6 cm)

13" Top ID x 12 1/4" Bottom ID (33 x 31.1 cm)

14" Top ID x 13 1/4" Bottom ID (35.6 x 33.7 cm)

15" Top ID x 14 1/4" Bottom ID (38.1 x 36.2 cm)

16" Top ID x 15 1/4" Bottom ID (40.6 x 38.7 cm)

17" Top ID x 16 1/4" Bottom ID (43.2 x 41.3 cm)

18" Top ID x 17 1/4" Bottom ID (45.7 x 43.8 cm)

HA90671.5

HA90071.5

HA90081.5

HA90091.5

HA90101.5

HA90111.5

HA90121.5

HA90131.5

HA90141.5

HA90151.5

HA90161.5

HA90171.5

HA90181.5

HC90671.5

HC90071.5

HC90081.5

HC90091.5

HC90101.5

HC90111.5

HC90121.5

HC90131.5

HC90141.5

HC90151.5

HC90161.5

HC90171.5

HC90181.5

**PAN DEPTH 2" (5.1 CM)**

**Pan Size**

6" Top ID x 5" Bottom ID (15.2 x 12.7 cm)

7" Top ID x 6" Bottom ID (17.8 x 15.2 cm)

8" Top ID x 7" Bottom ID (20.3 x 17.8 cm)

9" Top ID x 8" Bottom ID (22.9 x 20.3 cm)

10" Top ID x 9" Bottom ID (25.4 x 22.9 cm)

11" Top ID x 10" Bottom ID (27.9 x 25.4 cm)

12" Top ID x 11" Bottom ID (30.5 x 27.9 cm)

13" Top ID x 12" Bottom ID (33 x 30.5 cm)

14" Top ID x 13" Bottom ID (35.6 x 33 cm)

15" Top ID x 14" Bottom ID (38.1 x 35.6 cm)

16" Top ID x 15" Bottom ID (40.6 x 38.1 cm)

17" Top ID x 16" Bottom ID (43.2 x 40.6 cm)

18" Top ID x 17" Bottom ID (45.7 x 43.2 cm)

HA90672

HA90072

HA90082

HA90092

HA90102

HA90112

HA90122

HA90132

HA90142

HA90152

HA90162

HA90172

HA90182

HC90672

HC90072

HC90082

HC90092

HC90102

HC90112

HC90122

HC90132

HC90142

HC90152

HC90162

HC90172

HC90182





**A4000**  
Standard-weight  
18-ga., 1 mm  
aluminum



**HA4000**  
Heavy-weight  
14-ga., 1.5 mm  
aluminum



**HC4000**  
Hard coat anodized  
14-ga., 1.5 mm  
aluminum



**4000 SERIES - Straight-Sided**

Versatility and durability make the 4000 series one of our best sellers. Available in multiple diameters and depths from 3/4"-1" (1.9-2.5 cm), these pans are perfect for baking anything from double-dough pizzas to cookies and brownies. Each pan is made of high-quality, aluminum which heats quickly and efficiently and the straight sides ensure symmetrical, uniform, and smooth edges.

**PAN DEPTH 3/4" (1.9 CM)**

**Pan Size**

4" ID (10.2 cm)

**Standard-Weight**

**18-ga., 1 mm Aluminum**

**A4004**

**Heavy-Weight**

**14-ga., 1.5 mm Aluminum**

**HA4006**

**HA4007**

**HA4008**

**HA4009**

**HA4010**

**HA4011**

**HA4012**

**HA4013**

**HA4014**

**HA4015**

**HA4016**

**HA4017**

**HA4018**

**HA4019**

**HA4020**

**Hard Coat Anodized**

**14-ga., 1.5 mm Aluminum**

**HC4006**

**HC4007**

**HC4008**

**HC4009**

**HC4010**

**HC4011**

**HC4012**

**HC4013**

**HC4014**

**HC4015**

**HC4016**

**HC4017**

**HC4018**

**HC4019**

**HC4020**

**PAN DEPTH 1" (2.5 CM)**

**Pan Size**

6" ID (15.2 cm)

7" ID (17.8 cm)

8" ID (20.3 cm)

9" ID (22.9 cm)

10" ID (25.4 cm)

11" ID (27.9 cm)

12" ID (30.5 cm)

13" ID (33 cm)

14" ID (35.6 cm)

15" ID (38.1 cm)

16" ID (40.6 cm)

17" ID (43.2 cm)

18" ID (45.7 cm)

19" ID (48.3 cm)

20" ID (50.8 cm)

**Perf P** Perforating Pans  
**SuperPerf SP** Double the Holes  
**Nibs N** Raised Nibs or Bumps

**Covers** Separators and 7000 pans (pg. 415) can be used as covers  
**Stacking** 7000 pans (pg. 415) are stacking covers for tapered pans  
Refer to pg. 458-459 for care and use instructions. For pricing, visit [amnow.com](http://amnow.com)

**8000 SERIES - Straight-Sided** 

Straight-sided and deep, these pans are the hallmark of deep dish pizzas around the globe. Choose from a variety of diameter, depth, and material combinations for evenly and efficiently-cooked Chicago-style and pan pizza crusts. Plus, each size has straight sides for a perfect 90° angle crust every time.



**PAN DEPTH 1 1/2" (3.8 CM)**

**Pan Size**

- 6" ID (15.2 cm)
- 7" ID (17.8 cm)
- 8" ID (20.3 cm)
- 9" ID (22.9 cm)
- 10" ID (25.4 cm)
- 12" ID (30.5 cm)

**A8000 Standard-Weight 18-ga., 1 mm Aluminum**

- A80061.5
- A80071.5
- A80081.5
- A80091.5
- A80101.5
- A80121.5

**T8000 Tin Plate 22-ga., Tin Plate on Steel**

- T80061.5
- T80071.5
- T80081.5
- T80091.5
- T80101.5
- T80121.5



**A8000**  
Standard-weight 18-ga., 1 mm aluminum

**PAN DEPTH 2" (5.1 CM)**

**Pan Size**

- 6" ID (15.2 cm)
- 7" ID (17.8 cm)
- 8" ID (20.3 cm)
- 9" ID (22.9 cm)
- 10" ID (25.4 cm)
- 11" ID (27.9 cm)
- 12" ID (30.5 cm)
- 13" ID (33 cm)
- 14" ID (35.6 cm)
- 16" ID (40.6 cm)

- A80062
- A80072
- A80082
- A80092
- A80102
- A80112
- A80122
- A80132
- A80142
- A80162

- T80062
- T80072
- T80082
- T80092
- T80102
- T80112
- T80122
- T80132
- T80142
- T80162



**T8000**  
22-ga., tin plate on steel

**PAN DEPTH 1 1/2" (3.8 CM)**

**Pan Size**

- 6" ID (15.2 cm)
- 7" ID (17.8 cm)
- 8" ID (20.3 cm)
- 9" ID (22.9 cm)
- 10" ID (25.4 cm)
- 12" ID (30.5 cm)

**HA8000 Heavy-Weight 14-ga., 1.5 mm Aluminum**

- HA80061.5
- HA80071.5
- HA80081.5
- HA80091.5
- HA80101.5
- HA80121.5

**HC8000 Hard Coat Anodized 14-ga., 1.5 mm Aluminum**

- HC80061.5
- HC80071.5
- HC80081.5
- HC80091.5
- HC80101.5
- HC80121.5



**HA8000**  
Heavy-weight 14-ga., 1.5 mm aluminum

**PAN DEPTH 2" (5.1 CM)**

**Pan Size**

- 6" ID (15.2 cm)
- 7" ID (17.8 cm)
- 8" ID (20.3 cm)
- 9" ID (22.9 cm)
- 10" ID (25.4 cm)
- 11" ID (27.9 cm)
- 12" ID (30.5 cm)
- 13" ID (33 cm)
- 14" ID (35.6 cm)
- 16" ID (40.6 cm)
- 18" ID (45.7 cm)

- HA80062
- HA80072
- HA80082
- HA80092
- HA80102
- HA80112
- HA80122
- HA80132
- HA80142
- HA80162
- HA80182

- HC80062
- HC80072
- HC80082
- HC80092
- HC80102
- HC80112
- HC80122
- HC80132
- HC80142
- HC80162
- HC80182



**HC8000**  
Hard coat anodized 14-ga., 1.5 mm aluminum



8000 SERIES PANS ARE PERFECT FOR DEEP DISH PIZZA

**Perf P** Perforating Pans  
**SuperPerf SP** Double the Holes  
**Nibs N** Raised Nibs or Bumps

**Covers** Separators and 7000 pans (pg. 415) can be used as covers  
**Stacking** 7000 pans (pg. 415) are stacking covers for tapered pans  
 Refer to pg. 458-459 for care and use instructions. For pricing, visit [amnow.com](http://amnow.com)





USA

**HC5100**  
Hard coat  
anodized  
14-ga., 1.5 mm  
aluminum

USA



ALL PANS ARE 1 1/2" DEEP WITH 1" INSIDE PAN WHEN STACKED. BOTTOM OF ONE PAN NESTS 1/2" INTO THE TOP OF THE PAN BELOW.

**HA5100**  
Heavy-weight  
14-ga., 1.5 mm  
aluminum

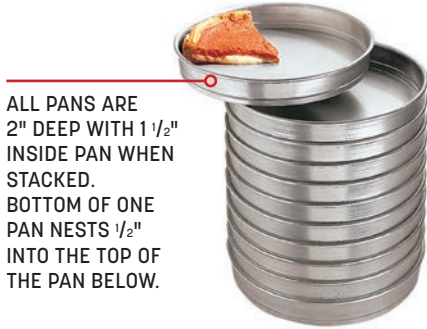

ALL PANS ARE 2" DEEP WITH 1 1/2" INSIDE PAN WHEN STACKED. BOTTOM OF ONE PAN NESTS 1/2" INTO THE TOP OF THE PAN BELOW.

**HA5000**  
Heavy-weight  
14-ga., 1.5 mm  
aluminum

**HC5000**  
Hard coat  
anodized  
14-ga., 1.5 mm  
aluminum



### 5100 SERIES - Straight-Sided - Self-Stacking

The 5100 Series is your new best friend! Available in a large range of diameters and a depth of 1 1/2" (3.8 cm), these pans provide a self-stacking ridge allowing you to prep and stack pizzas prior to cooking. No lids required.

#### PAN DEPTH 1 1/2" (3.8 CM)

##### Pan Size

6" Top ID x 5 7/8" Bottom ID (15.2 x 14.9 cm)
7" Top ID x 6 7/8" Bottom ID (17.8 x 17.5 cm)
8" Top ID x 7 7/8" Bottom ID (20.3 x 20 cm)
9" Top ID x 8 7/8" Bottom ID (22.9 x 22.5 cm)
10" Top ID x 9 7/8" Bottom ID (25.4 x 25.1 cm)
11" Top ID x 10 7/8" Bottom ID (27.9 x 27.6 cm)
12" Top ID x 11 7/8" Bottom ID (30.5 x 30.2 cm)
13" Top ID x 12 7/8" Bottom ID (33 x 32.7 cm)
14" Top ID x 13 7/8" Bottom ID (35.6 x 35.3 cm)
15" Top ID x 14 7/8" Bottom ID (38.1 x 37.8 cm)
16" Top ID x 15 7/8" Bottom ID (40.6 x 40.3 cm)

#### **HA5100 Heavy-Weight** **14-ga., 1.5 mm Aluminum**

<b>HA5106</b>
<b>HA5107</b>
<b>HA5108</b>
<b>HA5109</b>
<b>HA5110</b>
<b>HA5111</b>
<b>HA5112</b>
<b>HA5113</b>
<b>HA5114</b>
<b>HA5115</b>
<b>HA5116</b>

#### **HC5100 Hard Coat Anodized** **14-ga., 1.5 mm Aluminum**

<b>HC5106</b>
<b>HC5107</b>
<b>HC5108</b>
<b>HC5109</b>
<b>HC5110</b>
<b>HC5111</b>
<b>HC5112</b>
<b>HC5113</b>
<b>HC5114</b>
<b>HC5115</b>
<b>HC5116</b>

### 5000 SERIES - Straight-Sided - Self-Stacking

Proof, prep and cook all in one pan with the 5000 Series. Multiple diameter options along with an ample 2" depth (5.1 cm) make these pans ideal for deep dish pizzas. Plus, the convenient self-stacking design allows for prep and proofing in less space.

#### PAN DEPTH 2" (5.1 CM)

##### Pan Size

6" Top ID x 5 7/8" Bottom ID (15.2 x 14.9 cm)
7" Top ID x 6 7/8" Bottom ID (17.8 x 17.5 cm)
8" Top ID x 7 7/8" Bottom ID (20.3 x 20 cm)
9" Top ID x 8 7/8" Bottom ID (22.9 x 22.5 cm)
10" Top ID x 9 7/8" Bottom ID (25.4 x 25.1 cm)
11" Top ID x 10 7/8" Bottom ID (27.9 x 27.6 cm)
12" Top ID x 11 7/8" Bottom ID (30.5 x 30.1 cm)
13" Top ID x 12 7/8" Bottom ID (33 x 32.7 cm)
14" Top ID x 13 7/8" Bottom ID (35.6 x 35.3 cm)
15" Top ID x 14 7/8" Bottom ID (38.1 x 37.8 cm)
16" Top ID x 15 7/8" Bottom ID (40.6 x 40.3 cm)
17" Top ID x 16 7/8" Bottom ID (43.2 x 42.9 cm)
18" Top ID x 17 7/8" Bottom ID (45.7 x 45.4 cm)

#### **HA5000 Heavy-Weight** **14-ga., 1.5 mm Aluminum**

<b>HA5006</b>
<b>HA5007</b>
<b>HA5008</b>
<b>HA5009</b>
<b>HA5010</b>
<b>HA5011</b>
<b>HA5012</b>
<b>HA5013</b>
<b>HA5014</b>
<b>HA5015</b>
<b>HA5016</b>
<b>HA5017</b>
<b>HA5018</b>

#### **HC5000 Hard Coat Anodized** **14-ga., 1.5 mm Aluminum**

<b>HC5006</b>
<b>HC5007</b>
<b>HC5008</b>
<b>HC5009</b>
<b>HC5010</b>
<b>HC5011</b>
<b>HC5012</b>
<b>HC5013</b>
<b>HC5014</b>
<b>HC5015</b>
<b>HC5016</b>
<b>HC5017</b>
<b>HC5018</b>



18914

## ROUND SEPARATORS



To choose a separator, measure the top outside diameter of your pan and add at least 2". Unfinished edges may be sharp.

### Standard-Weight 18-ga., 1 mm Aluminum

<b>18907</b>	7 1/2" OD (19.1 cm) Separates 5 1/2" (14 cm) Dia. and smaller pans
<b>18908</b>	8" OD (20.3 cm) Separates 6" (15.2 cm) Dia. and smaller pans
<b>18909</b>	9" OD (22.9 cm) Separates 7" (17.8 cm) Dia. and smaller pans
<b>18910</b>	10" OD (25.4 cm) Separates 8" (20.3 cm) Dia. and smaller pans
<b>18911</b>	11" OD (27.9 cm) Separates 9" (22.9 cm) Dia. and smaller pans
<b>18912</b>	12" OD (30.5 cm) Separates 10" (25.4 cm) Dia. and smaller pans
<b>18913</b>	13" OD (33 cm) Separates 11" (27.9 cm) Dia. and smaller pans
<b>18914</b>	14" OD (35.6 cm) Separates 12" (30.5 cm) Dia. and smaller pans
<b>18915</b>	15" OD (38.1 cm) Separates 13" (33 cm) Dia. and smaller pans
<b>18916</b>	16" OD (40.6 cm) Separates 14" (35.6 cm) Dia. and smaller pans
<b>18917</b>	17" OD (43.2 cm) Separates 15" (38.1 cm) Dia. and smaller pans
<b>18918</b>	18" OD (45.7 cm) Separates 16" (40.6 cm) Dia. and smaller pans
<b>18919</b>	19" OD (48.3 cm) Separates 17" (43.2 cm) Dia. and smaller pans
<b>18920</b>	20" OD (50.8 cm) Separates 18" (45.7 cm) Dia. and smaller pans

## 7000 SERIES



These can be used as stacking covers for our DEP, 2000 and 9000 Series, or just as covers for our 4000, 8000, 5000 and 5100 Series. To choose a cover, measure the top inside diameter and reference the list below.

### 7000 Standard-Weight 18-ga., 1 mm Aluminum

<b>7006</b>	5 3/4" ID x 7 1/2" OD x 1/4" Deep, for 6" ID pans (14.6 x 19.1 x 0.6 cm, for 15.2 cm pans) Cover only for 4006, 8006, 5006, 5106, Stacking Cover for DEP6, 2006, 9006
<b>7007</b>	6 3/4" ID x 8 1/2" OD x 1/4" Deep, for 7" ID pans (17.1 x 21.6 x 0.6 cm, for 17.8 cm pans) Cover only for 4007, 8007, 5007, 5107, Stacking Cover for DEP7, 2007, 9007
<b>7008</b>	7 3/4" ID x 9 1/2" OD x 1/4" Deep, for 8" ID pans (19.7 x 24.1 x 0.6 cm, for 20.3 cm pans) Cover only for 4008, 8008, 5008, 5108, Stacking Cover for DEP8, 2008, 9008
<b>7009</b>	8 3/4" ID x 10 1/2" OD x 1/4" Deep, for 9" ID pans (22.2 x 26.7 x 0.6 cm, for 22.9 cm pans) Cover only for 4009, 8009, 5009, 5109, Stacking Cover for DEP9, 2009, 9009
<b>7010</b>	9 3/4" ID x 11 1/2" OD x 1/4" Deep, for 10" ID pans (24.8 x 29.2 x 0.6 cm, for 25.4 cm pans) Cover only for 4010, 8010, 5010, 5110, Stacking Cover for DEP10, 2010, 9010
<b>7011</b>	10 3/4" ID x 12 1/2" OD x 1/4" Deep, for 11" ID pans (27.3 x 31.8 x 0.6 cm, for 27.9 cm pans) Cover only for 4011, 8011, 5011, 5111, Stacking Cover for DEP11, 2011, 9011
<b>7012</b>	11 3/4" ID x 13 1/2" OD x 1/4" Deep, for 12" ID pans (29.8 x 34.3 x 0.6 cm, for 30.5 cm pans) Cover only for 4012, 8012, 5012, 5112, Stacking Cover for DEP12, 2012, 9012
<b>7013</b>	12 3/4" ID x 14 1/2" OD x 1/4" Deep, for 13" ID pans (32.4 x 36.8 x 0.6 cm, for 33 cm pans) Cover only for 4013, 8013, 5013, 5113, Stacking Cover for DEP13, 2013, 9013
<b>7014</b>	13 3/4" ID x 15 1/2" OD x 1/4" Deep, for 14" ID pans (34.9 x 39.4 x 0.6 cm, for 35.6 cm pans) Cover only for 4014, 8014, 5014, 5114, Stacking Cover for DEP14, 2014, 9014
<b>7015</b>	14 3/4" ID x 16 1/2" OD x 1/4" Deep, for 15" ID pans (37.5 x 41.9 x 0.6 cm, for 38.1 cm pans) Cover only for 4015, 8015, 5015, 5115, Stacking Cover for DEP15, 2015, 9015
<b>7016</b>	15 3/4" ID x 17 1/2" OD x 1/4" Deep, for 16" ID pans (40 x 44.5 x 0.6 cm, for 40.6 cm pans) Cover only for 4016, 8016, 5016, 5116, Stacking Cover for DEP16, 2016, 9016
<b>7017</b>	16 3/4" ID x 18 1/2" OD x 1/4" Deep, for 17" ID pans (42.5 x 47 x 0.6 cm, for 43.2 cm pans) Cover only for 4017, 8017, 5017, 5117, Stacking Cover for DEP17, 2017, 9017
<b>7018</b>	17 3/4" ID x 19 1/2" OD x 1/4" Deep, for 18" ID pans (45.1 x 49.5 x 0.6 cm, for 45.7 cm pans) Cover only for 4018, 8018, 5018, 5118, Stacking Cover for DEP18, 2018, 9018



7016





## SQUARE DEEP DISH PANS

Crafted from heavy-weight 14-ga., 1.5 mm aluminum, these straight-sided square pans can be perforated with the same round pattern used on our Perf Discs on pg. 404. Hard Coat Anodized 14-ga., 1.5 mm Aluminum not shown.

### PAN DEPTH 1" (2.5 CM)

#### Pan size

6" Sq. (15.2 cm)  
8" Sq. (20.3 cm)  
10" Sq. (25.4 cm)  
12" Sq. (30.5 cm)  
14" Sq. (35.6 cm)  
16" Sq. (40.6 cm)

**Heavy-Weight**  
**14-ga., 1.5 mm Aluminum**

SQ610  
SQ810  
SQ1010  
SQ1210  
SQ1410  
SQ1610

**Hard Coat Anodized**  
**14-ga., 1.5 mm Aluminum**

HCSQ610  
HCSQ810  
HCSQ1010  
HCSQ1210  
HCSQ1410  
HCSQ1610

### PAN DEPTH 1 1/2" (3.8 CM)

#### Pan size

6" Sq. (15.2 cm)  
8" Sq. (20.3 cm)  
10" Sq. (25.4 cm)  
12" Sq. (30.5 cm)  
14" Sq. (35.6 cm)  
16" Sq. (40.6 cm)

SQ615  
SQ815  
SQ1015  
SQ1215  
SQ1415  
SQ1615

HCSQ615  
HCSQ815  
HCSQ1015  
HCSQ1215  
HCSQ1415  
HCSQ1615

### PAN DEPTH 2" (5.1 CM)

#### Pan size

6" Sq. (15.2 cm)  
8" Sq. (20.3 cm)  
10" Sq. (25.4 cm)  
12" Sq. (30.5 cm)  
14" Sq. (35.6 cm)  
16" Sq. (40.6 cm)

SQ620  
SQ820  
SQ1020  
SQ1220  
SQ1420  
SQ1620

HCSQ620  
HCSQ820  
HCSQ1020  
HCSQ1220  
HCSQ1420  
HCSQ1620



## SQUARE SEPARATORS

Use these heavy-weight 14-ga., 1.5 mm aluminum separators as serving pans or stackable covers for any of our Square Deep Dish Pans.

<b>SQ600</b>	8 1/2" Sq. (21.6 cm) for 6" (15.2 cm) pan
<b>SQ800</b>	10 1/2" Sq. (26.7 cm) for 8" (20.3 cm) pan
<b>SQ1000</b>	12 1/2" Sq. (31.8 cm) for 10" (25.4 cm) pan
<b>SQ1200</b>	14 1/2" Sq. (36.8 cm) for 12" (30.5 cm) pan
<b>SQ1400</b>	16 1/2" Sq. (41.9 cm) for 14" (35.6 cm) pan
<b>SQ1600</b>	18 1/2" Sq. (47 cm) for 16" (40.6 cm) pan

## Rectangular Deep Dish Pans

Made of heavy-weight 14-ga. aluminum, these rectangular pizza pans are designed for specialty pizzas. Feed the entire party with its two-foot length and choice of depth.

### **Heavy-Weight** **14-ga., 1.5 mm Aluminum**

<b>TF122410</b>	24" L x 12" W x 1" H (61 x 30.5 x 2.5 cm)
<b>TF122415</b>	24" L x 12" W x 1 1/2" H (61 x 30.5 x 3.8 cm)
<b>TF122420</b>	24" L x 12" W x 2" H (61 x 30.5 x 5.1 cm)

### **Hard Coat Anodized** **14-ga., 1.5 mm Aluminum**

<b>HCTF122410</b>	24" L x 12" W x 1" H (61 x 30.5 x 2.5 cm) (not shown)
<b>HCTF122415</b>	24" L x 12" W x 1 1/2" H (61 x 30.5 x 3.8 cm) (not shown)
<b>HCTF122420</b>	24" L x 12" W x 2" H (61 x 30.5 x 5.1 cm) (not shown)

### Rectangular Hard Coat Anodized Aluminum Long Pans

Create a decadent, crispy crust on 2-3 sides of each piece with these heavy-weight, hard coat aluminum long pizza pans. Creates 3-6 equal 4" cuts.

- HCLP12** 12" L x 4" W x 1 5/8" H  
(30.5 x 10.2 x 4.1 cm)
- HCLP16** 16" L x 4" W x 1 5/8" H  
(40.6 x 10.2 x 4.1 cm)
- HCLP24** 24" L x 4" W x 1 5/8" H  
(61 x 10.2 x 4.1 cm)

### Sicilian-Style Hard Coat Anodized Aluminum Pans

Now you can bake pizza just like Nonna used to make! Manufactured of heavy-duty hard coat aluminum, our Sicilian pizza pans are available in all the most popular square and rectangular sizes. The tapered 1" (2.5 cm) depth and crisp angled corners provide efficient cooking, easy clean-up and space-saving nestability for storage.

- HCSS12** 12" Sq. x 1" H  
(30.5 x 2.5 cm)
- HCSS14** 14" Sq. x 1" H  
(35.6 x 2.5 cm)
- HCSS16** 16" Sq. x 1" H  
(40.6 x 2.5 cm)
- HCSS1411** 14" L x 10" W x 1" H  
(35.6 x 25.4 x 2.5 cm)
- HCSS1812** 18" L x 12" W x 1" H  
(45.7 x 30.5 x 2.5 cm)
- HCSS248** 24" L x 8" W x 1" H  
(61 x 20.3 x 2.5 cm)
- HCSS2416** 24" L x 16" W x 1" H  
(61 x 40.6 x 2.5 cm)

### Detroit-Style Hard Coat Anodized Aluminum Pans

Detroit-style pizza lovers, rejoice! These extra-deep pans are the secret to baking Motown-worthy pies every time.

- HCDS108** 10" L x 8" W x 2 3/8" H  
(25.4 x 20.3 x 6 cm)
- HCDS1410** 14" L x 10" W x 2 1/2" H  
(35.6 x 25.4 x 6.4 cm)
- HCDS1712** 17" L x 12" W x 2 3/4" H  
(43.2 x 30.5 x 7 cm)

### Aluminium Lids

- DSP11** Fits HCDS108, 11 1/2" L x 9 1/2" W  
(29.2 x 24.1 cm)  
(not shown)
- DSP15** Fits HCDS1410, 15 1/2" L x 11 1/2" W  
(39.4 x 29.2 cm)
- DSP18** Fits HCDS1712, 18 1/2" L x 13 1/2" W  
(47 x 34.3 cm)

### Flexible Server

Get to every bit of buttery crust with this dishwasher-safe server.

- FS9** 9" L x 4 1/4" W  
(22.9 x 10.8 cm)



Shown with FS9 server, OWBB1 crate and CSC4CL sauce cup



HCDS1410 shown with DSP15 lid

HCDS1712 shown with DSP18 lid

FS9

HOT





## Square Wide-Rim Pans

Our most popular pizza serving pans have gotten a makeover. These Square Wide-Rim Pizza Pans expertly serve up anything from Sicilian to Detroit-Style pizzas. Made of durable 18-gauge aluminum, these pans can also double as modern serving trays in dining halls and quick serve restaurants.

**STP10** 10" Sq. (25.4 cm)

**STP12** 12" Sq. (30.5 cm)

**STP14** 14" Sq. (35.6 cm)

**STP16** 16" Sq. (40.6 cm)

## Coupe Collection Trays

Elegant yet simple, the Coupe Collection offers a level of subtle refinement to the tabletop. This satin-finished line of stainless steel dinnerware is a versatile (yet durable) suggestion in modern dining.

**SSP4** 4" Dia. x  $\frac{3}{8}$ " H (10.2 x 1 cm)

**SSP6** 6" Dia. x  $\frac{3}{8}$ " H (15.2 x 1 cm)

**SSP8** 8" Dia. x  $\frac{3}{8}$ " H (20.3 x 1 cm)

**SSP9** 9" Dia. x  $\frac{3}{8}$ " H (22.9 x 1 cm)

**SSP10** 10½" Dia. x  $\frac{3}{8}$ " H (26.7 x 1 cm)

**SSP12** 12" Dia. x  $\frac{3}{8}$ " H (30.5 x 1 cm)

**SSP13** 13" Dia. x  $\frac{3}{8}$ " H (33 x 1 cm)

**SSP14** 14" Dia. x  $\frac{3}{8}$ " H (35.6 x 1 cm)

**SSP15** 15" Dia. x  $\frac{3}{8}$ " H (38.1 x 1 cm)

**SSP16** 16" Dia. x  $\frac{3}{8}$ " H (40.6 x 1 cm)



FROM SMALLEST  
TO LARGEST:

**SSP4**  
**SSP6**  
**SSP8**  
**SSP9**  
**SSP10**  
**SSP12**  
**SSP13**  
**SSP14**  
**SSP15**  
**SSP16**

## Onyx Galvanized Wide Rim Pans

The days of using a standard aluminum pan for serving are over. You now have options! These dark galvanized pans are perfect for serving up anything from pizza to burritos.

**GTP10** 10" Dia. x  $\frac{3}{8}$ " H (25.4 x 1 cm)

**GTP12** 12" Dia. x  $\frac{3}{8}$ " H (30.5 x 1 cm)

**GTP14** 14" Dia. x  $\frac{3}{8}$ " H (35.6 x 1 cm)

**GTP16** 16" Dia. x  $\frac{3}{8}$ " H (40.6 x 1 cm)

**GTP18** 18" Dia. x  $\frac{3}{8}$ " H (45.7 x 1 cm)



FROM SMALLEST  
TO LARGEST:

**GTP10**  
**GTP12**  
**GTP14**  
**GTP16**  
**GTP18**



### Ceramic Pizza Trays

These ceramic trays add a touch of old-world charm to pizza presentation. Available in four sizes to fit most standard pizzas.

- CERAM12** 12" Dia. (30.5 cm)
- CERAM14** 14" Dia. (35.6 cm)  
(not shown)
- CERAM16** 16" Dia. (40.6 cm)
- CERAM18** 18" Dia. (45.7 cm)

### Melamine Pizza Plates

Serve up your favorite pie on these versatile, durable and dishwasher-safe melamine pizza plates. A sleek way to plate up any slice!

- MTP10** 10" Dia. x ¾" H (25.4 x 1.9 cm)
- MTP12** 12" Dia. x 1 ½" H (30.5 x 2.9 cm)
- MTP14** 14" Dia. x 1 ½" H (35.6 x 2.9 cm)
- MTP16** 16" Dia. x 1 ½" H (40.6 x 2.9 cm)
- MTP18** 18" Dia. x 1 ¾" H (45.7 x 3.5 cm)





HOT



STONE13

CAN ALSO KEEP PIZZAS WARM  
IN HEATED DISPLAY CASES

### Ceramic Pizza Stones

These ceramic baking stones create a light, crispy crust by distributing heat evenly and efficiently.

**STONE13** Round  
13" Dia. x  $\frac{3}{8}$ " H (33 x 1 cm)

**STONE12** Rectangular  
15" L x 12" W x  $\frac{3}{8}$ " H (38.1 x 30.5 x 1 cm)

**STONE15** Round  
15" Dia. x  $\frac{3}{8}$ " H (38.1 x 1 cm)

**STONE14** Rectangular  
15" L x 14" W x  $\frac{3}{8}$ " H (38.1 x 35.6 x 1 cm)



STONE12



STONE15



STONE14

## Nera Nano Enamel

### Pizza Stones NEW

Our Nera Nano Enamel Pizza Stones are made with brand new technology. The result is a stone that looks and feels like cast iron but without the extra weight. Each stone is naturally non-stick, abrasion-resistant and able to withstand high oven temperatures.

**PSB16** Round  
16" Dia. x 3/8" H  
(40.6 x 1 cm)

**PSB1416** Rectangular  
16" L x 14" W x 3/8" H  
(40.6 x 35.6 x 1 cm)

### Deluxe Pizza Stones

Perfect for spaces where hearth baking isn't possible, these stones are designed with ideal thickness and porosity for heat retention. Made of cordierite, a lead-free firebrick material.

**PS125** Round  
12 1/2" Dia. x 3/8" H  
(31.8 x 1 cm) (not shown)

**PS1575** Round  
15 3/4" Dia. x 7/8" H  
(40 cm x 2.2 cm)

**PSS12** Square  
12" Sq. x 1/4" H  
(30.5 x 0.6 cm) (not shown)

**PS1515** Square  
15" Sq. x 1/2" H  
(38.1 x 1.3 cm)

**PS1116** Rectangular  
16" L x 11" W x 3/4" H  
(40.6 x 27.9 x 1.9 cm)

**PS1416** Rectangular  
16" L x 14" W x 7/8" H  
(40.6 x 35.6 x 2.2 cm)







### Standard Dough Box <sup>USA</sup>

Tough ABS construction with reinforced sides, corners and edges. Stacks securely. Dishwasher-safe.

**DRB18230** 18" L x 26" W x 3" H  
(45.7 x 66 x 7.6 cm)

**DRBC1826** Cover for Dough Pan  
18 1/4" L x 26 1/4" W x 3/4" H  
(46.4 x 66.7 x 1.9 cm)

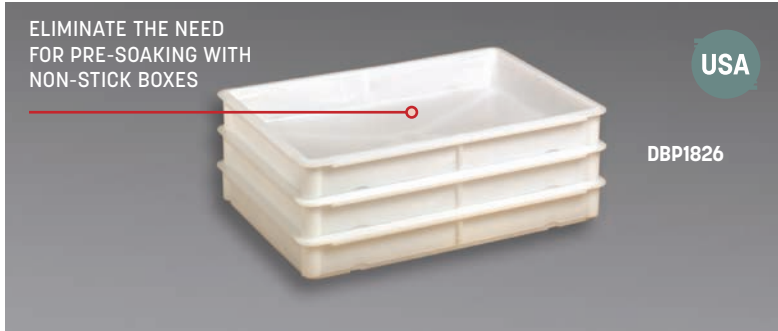

### Heavy-Duty Dough Box <sup>USA</sup>

Our premium dough boxes are manufactured from tough Teflon® copolymer for the ultimate in non-stick. Cross-stack lugs enable fast and secure cross-stacking. Interchangeable with most other dough boxes.

**DBP1826** 18" L x 26" W x 3 1/8" H  
(45.7 x 66 x 7.9 cm)

### Deluxe Anodized Aluminum Dough Pans <sup>USA</sup>

Constructed from heavy-weight 14-ga., 1.5 mm tempered aluminum in a secure, self-stacking design for easy storage. Cleans easily and refrigerates quickly. Eastern pan stacks with pans of similar shape.

#### Small Straight-Sided Stacking <sup>USA</sup>

**DRPS5725** 7 7/8" OD x 7" ID x 2 1/2" H  
(20 x 17.8 x 6.4 cm) 32 oz. (0.9 L) capacity

**7007** Cover for DRPS5725  
8 1/4" Dia. x 1/4" H (21 x 0.6 cm)

**DRPS5825** 8 5/8" OD x 8" ID x 2 1/2" H  
(21.9 x 20.3 x 6.4 cm) 40 oz. (1.2 L) capacity

**7008** Cover for DRPS5825  
9 3/8" Dia. x 1/4" H (23.8 x 0.6 cm)

#### Standard Straight-Sided Stacking <sup>USA</sup>

**DRP774** 7 7/8" OD x 7 1/4" ID x 2 1/2" H  
(20 x 18.4 x 6.4 cm) 40 oz. (1.2 L) capacity

**7007** Cover for DRP774  
8 1/4" Dia. x 1/4" H (21 x 0.6 cm)

**DRP884** 9" OD x 8 3/8" ID x 3 3/8" H  
(22.9 x 21.3 x 8.6 cm) 80 oz. (2.4 L) capacity

**7008E** Cover for DRP884  
9 3/8" Dia. x 1/4" H (23.8 x 0.6 cm)

#### Eastern Stacking

**DRPE800** 8 1/4" OD x 7 1/2" ID x 2 5/8" H  
(21 x 19.1 x 6.7 cm) 48 oz. (1.41 L) capacity

**7007E** Cover for DRPE800  
8 1/2" Dia. x 1/4" H (21.6 x 0.6 cm)

**DRPE878** 8 7/8" OD x 8 1/4" ID x 3" H  
(22.5 x 20.9 x 7.6 cm) 96 oz. (2.8 L) capacity

**7008E** Cover for DRPE878  
9 3/8" Dia. x 1/4" H (23.8 x 0.6 cm)



### Rolling Pins and Pie Rollers

Whatever your preferred style of roller is, American Metalcraft has you covered.

- PR18** Wood  
1 1/4" Dia. x 18" L  
(3.2 x 45.7 cm)
- PRP500** Stainless Steel  
1 3/4" Dia. x 5 1/2" W x 8 3/4" L  
(4.4 x 14 x 22.2 cm)
- WRPC5713** Wood  
13" L (33 cm)  
(not shown)
- RP5718** Aluminum  
18" L (45.7 cm)
- WRPC5715** Wood  
15" L (38.1 cm)  
(not shown)
- WRPC5718** Wood  
18" L (45.7 cm)
- WRPCHARDWARE** 2 Extra Handles each,  
Stainless Steel End Caps  
and Nylon Bearings for wood  
rolling pins



### Dough Cutters and Scrapers

Features stainless steel blade and wood or plastic handle.

- DS6704** Wood Handle  
6" W x 4 1/2" H (15.2 x 11.4 cm)
- DS6706** Wood Handle  
6" W x 6" H (15.2 x 15.2 cm)
- DSP6705** Plastic Handle  
6" W x 4 1/2" H (15.2 x 11.4 cm)

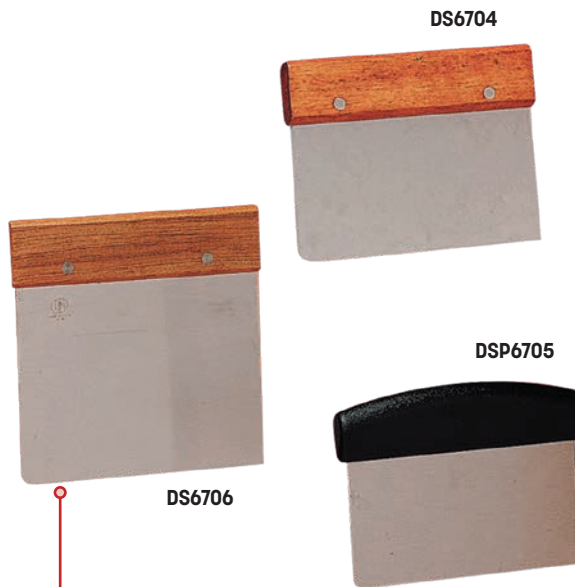

ROUNDED CORNER SCRAPERS CLEAN  
WITHOUT EXCESSIVE SCRATCHING



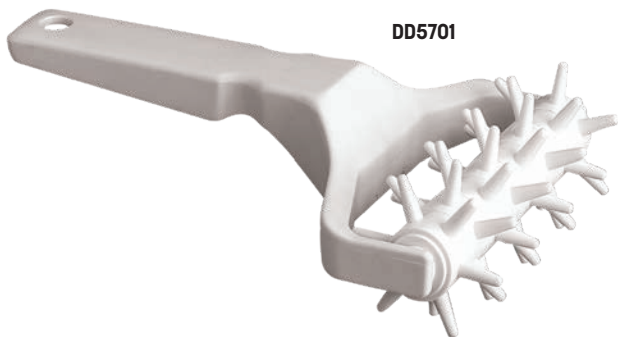

### Heavy-Duty Plastic Roller Dockers

Individual wheels with plastic points spin independently on a stainless steel axle.

**DD5274** Half-Size Plastic Docker  
Plastic Handle  
3 1/2" W x 8 3/4" L (8.9 x 22.2 cm)

**DD5705** Full-Size Plastic Docker  
Aluminum Handle  
5 1/2" W x 8 3/4" L (14 x 22.2 cm)

**DDW5705** Replacement Wheel

### Ten-Wheel Casted Handle Dough Docker

Features a one-piece, heavy-duty cast aluminum ergonomic handle and interchangeable ten-piece plastic wheel base.

**DDCH7755** 6 1/4" W x 9 1/4" L (15.9 x 23.5 cm)

**DDW5705** Replacement Wheel

### Casted Handle Dough Docker

One-piece cast aluminum ergonomic handle for great durability. Features 3/8" (1 cm) stainless steel pins embedded in plastic roller.

**DDCH7744** 6 1/4" W x 9 1/4" L (15.9 x 23.5 cm)

### All-Plastic Dough Docker

One-piece plastic core features 3/8" (1.6 cm) long pins. Dishwasher-safe.

**DD5701** Plastic Docker

### Heavy-Duty Roller Dockers

Stainless steel pins are permanently embedded in a plastic core. Crafted with stainless steel axle and sanitary solid aluminum handle.

**DD5275** Half-Size Plastic Docker  
2 3/4" W x 1 3/4" Dia. Barrel  
(7 x 4.4 cm)

**DD5704** Full-Size Plastic Docker  
5" W x 1 3/4" Dia. Barrel  
(12.7 x 4.4 cm)



### Long-Pin Docker

Unit made with two sets of interlocking plastic pins.

**DD5703** Plastic Pin Docker 7/8" L Pins (2.2 cm)  
3 1/2" W x 8 1/2" Overall  
(8.9 x 21.6 cm)

**DDW5703** Replacement Wheel

### Super Heavy-Duty Pan Grippers

An extra-durable stainless steel alternative to our standard Pan Grippers, these pieces are 50% heavier. Use HDD94 with shallow pans such as our CAR, DEP and 4000 Series. Use HDS95 with our 3800, 5000, 5100, 8000 and 9000 Series pans.

**HDD94** For Shallow Pans

**HDS95** For Deep Pans



### Pan Grippers

#### Cast Aluminum Pan Gripper

Reinforced bottom curves provide better grip. Spring-loaded for easy release of pan. Designed for use with DEP, 3800, 4000, 5000, 5100, 8000 and 9000 Series pans.

**G9595** 8 1/8" L (20.6 cm)

#### Nylon Pan Gripper

Dishwasher-safe, high-heat-resistant. Designed for use with DEP, 3800, 4000, 5000, 5100, 8000 and 9000 Series pans.

**N9494** 8 1/4" L (21 cm)

#### Nickel-Plated Pan Grippers

Crafted from heavy-tempered steel. Use 9525 with shallow pans such as our CAR, DEP and 4000 Series. Use I9540 with our 3800, 5000, 5100, 8000 and 9000 Series pans.

**9525** For Shallow Pans

**I9540** For Deep Pans



50% HEAVIER THAN STANDARD PAN GRIPPERS







HPP16



HPP7

### Heart-Shaped Aluminum Pizza Pans

These playful pans aren't just for pizza. Share the love with cakes, brownies and oversized cookies too.

**HPP7** 7" W x 1 1/2" Deep (17.8 x 3.8 cm)

**HPP16** 16" W x 1 1/2" Deep (40.6 x 3.8 cm)



EM199

### Mini Stainless Steel Number Tents

Made of dishwasher-safe, high-heat-resistant stainless steel, these double-sided embossed number tents make table service easy as pie. 1" Sq. x 1 1/2" W (2.5 x 3.8 cm).

**EM199** Nos. 1-99

**EM1200** Nos. 1-200

**EM200** Nos. 201-400

**EM400** Nos. 401-600

### Loft Collection Acacia Wood Shaker Caddy

Stylishly bring the condiments to the table with this beautifully designed caddy from the Loft Collection. Made of intricately grained Acacia wood, this caddy includes three holders for a trio of shakers or loose condiments. And the smart inset design allows for a solid fit for most 6 to 12 oz. shakers. Knockdown handle also allows for smart shipping and storage.

**SCAW7** Fits Most 6 oz. (177.4 mL) to 12 oz. (354.9 mL) Shakers  
7" L x 6 1/2" W x 8 5/8" H  
(17.8 x 16.5 x 21.9 cm)



SCAW7

Shown with GLADT6, 3307 and BEE319 shakers



FITS AN ASSORTMENT OF SHAKERS DUE TO BUILT-IN LEDGE



USE TO CREATE A FRESH CONDIMENT STATION



**SHAKER TOPS AND BOTTOMS**

With glass bodies and a variety of stainless steel tops, these shakers feature eye-catching contemporary designs.

**2 oz. Glass Contemporary Shakers**

Measures 2" Dia. x 3 1/8" H (5.1 x 7.9 cm).

- GLACT2** Shaker with Cheese Top
- GLAST2** Shaker with Slotted Top
- GLADT2** Shaker with Adjustable Dial Top
- GLBASE** Shaker Base Only

**2 oz. Replacement Tops**

- CT2** Cheese Round Holes
- ST2** Spice Slotted
- DT2** Adjustable Dial Top
- CAP2** Plastic Cover for Top



**6 oz. Glass Contemporary Shakers**

Measures 2 3/8" Dia. x 4 1/2" H (6 x 11.4 cm).

- 4406** Shaker with Cheese Top
- 4407** Shaker with Slotted Top
- GLADT6** Shaker with Adjustable Dial Top
- GLA600** Shaker Base Only

**6 oz. Replacement Tops**

- 4406T** Cheese Round Holes
- 4407T** Spice Slotted
- DT6** Adjustable Dial Top
- CAP25** Plastic Cover for Top



**6 oz. Vintage Collection Square Glass Shakers**

Part of our Vintage Collection, these cheese and spice shakers feature stainless steel caps and are dishwasher-safe. Each 6 oz. (177.4 mL) shaker measures 2 5/8" Sq. x 3 3/4" H (6.7 x 9.5 cm).

- GSC6** Shaker with Cheese Top
- GSS6** Shaker with Slotted Top
- GSD6** Shaker with Adjustable Dial Top

CHECK OUT OUR MATCHING VINTAGE S&P SHAKERS ON PG. 151







### 6 oz. Swirl Jar Shakers

Our take on classic pizzeria styling.  
6 oz. (177.4 mL) capacity.  
2 5/8" Dia. x 3 1/2" H (6.7 x 8.9 cm).

#### Glass

- 3306** Shaker with Cheese Top
- 3307** Shaker with Spice Top

#### PET

- LX306** Shaker with Cheese Top (not shown)
- LX307** Shaker with Spice Top (not shown)

### Replacement Shaker Tops

#### 6 oz. and 8 oz. Tops

- 3307T** Small Spice Slotted
- 3306T** Cheese with Small Round Holes

#### 12 oz. Tops

- 3312T** Cheese with Large Round Holes
- 3316T** Sugar Flap Top
- 3317T** Spice Slotted
- 3319T** Cheese with Extra Large Holes
- 3318T** Dredge with Small Round Holes



### 8 oz. Glass Shakers

Ideal for condiments such as red pepper, oregano and parmesan cheese. 8 oz. (236.6 mL) capacity. 2 3/4" Dia. x 3 7/8" H (7 x 9.9 cm).

- 3308** Shaker with Cheese Top
- 3309** Shaker with Spice Top



### Mini Glass Shakers and Caddy

This stainless steel rack and its matching glass shakers are a fraction of the size of regular shakers.

**MGLA3** Base, 2 oz. (59.1 mL)  
1 3/8" Dia. x 3 5/8" H  
(4.1 x 9.2 cm)

**MCADDY** Caddy  
4 1/2" L x 2 1/4" W x 5 1/2" H  
(11.4 x 5.7 x 14 cm)

**MGLCS** Set  
(Includes Caddy with Cheese and Spice Shakers)

#### Replacement Mini Lids

**M30SP** Salt and Pepper

**M312T** Cheese

**M316T** Sugar Flap Top

**M317T** Spice

### 6 oz. Glass Beehive Shakers

This 6 oz. (177.4 mL) beehive shaker features a charming pear-shaped design.  
2" Dia. x 3 1/2" H (5.1 x 8.9 cm)

**BEE606** Shaker with Cheese Top

**BEE607** Shaker with Spice Top

**BEE600** Shaker Base Only

### 12 oz. Glass Beehive Shakers

These stylishly ridged beehive shakers measure 3" Dia. x 5 3/8" H (7.6 x 13.7 cm).

**BEE312** Shaker with Cheese Top

**BEE316** Shaker with Sugar Flap Top

**BEE317** Shaker with Spice Top

**BEE318** Shaker with Dredge Top

**BEE319** Shaker with Extra Large Holes  
Cheese Top

**BEE300** Shaker Base Only



MINIATURE DESIGN IS EXTRA EASY TO CARRY



PAIR WITH OTHER PIECES FROM OUR BEEHIVE LINE (PG. 148)





## 12 oz. Classic Shakers

These 12 oz. (354.9 mL) capacity shakers have a standard straight-sided fluted shape and are stain-proof and dishwasher-safe. The SAN plastic shakers are nearly indestructible. 3" Dia. x 5 3/8" H (7.6 x 13.7 cm).

### Glass

- GLA312** Shaker with Cheese Top
- GLA316** Shaker with Sugar Flap Top
- GLA317** Shaker with Spice Top
- GLA318** Shaker with Dredge Top
- GLA319** Shaker with Extra Large 1/4" Holes Cheese Top
- GLA300** Shaker Base Only

### SAN Plastic

- SAN312** Shaker with Cheese Top
- SAN316** Shaker with Sugar Flap Top
- SAN317** Shaker with Spice Top
- SAN318** Shaker with Dredge Top
- SAN319** Shaker with Extra Large 1/4" Holes Cheese Top
- SAN300** Shaker Base Only



## 12 oz. Tapered Plastic Shakers

These shakers feature heavy-duty plastic bases and stainless steel tops. Odorless and dishwasher-safe. 3" Dia. x 5 3/8" H (7.6 x 13.7 cm).

- 3312** Shaker with Cheese Top
- 3316** Shaker with Sugar Flap Top
- 3317** Shaker with Spice Top
- 3318** Shaker with Dredge Top
- 3319** Shaker with Extra Large 1/4" Holes Cheese Top
- 3300** Shaker Base Only

## 16 oz. Stainless Steel Shakers

In cool brushed stainless steel, these shakers feature fine or coarse holes for different seasonings. 16 oz. (473.2 mL) capacity. 3" Dia. x 7" H (7.6 x 17.8 cm).

- TSF7** Shaker with Fine Holes
- TSC7** Shaker with Coarse Holes





### Square Pizza Paper

In your choice of three classic styles.  
1000 16" (40.6 cm) sheets per pack.

- PPRW1616 White
- PPCH4N Natural
- PPRN1616 Newspaper

### Jumbo Stainless Steel Soup Cans

Whether you use them as risers or condiment holders, these rustic cans offer versatile solutions with a memorable twist.

- CSM40 40 oz. (1.2 L)  
6 1/4" Dia. x 3" H (15.9 x 7.6 cm)
- CSM2 2 qt. (1.9 L)  
5 1/4" Dia. x 6" H (13.3 x 15.2 cm)
- CSM3 3 1/4 qt. (3.1 L)  
6 1/4" Dia. x 7" H (15.9 x 17.8 cm)



CSM40 shown with 4406 and GLADT6 shakers





SDRCK4 shown with TP14 tray and MGLA3 shakers

SDRCK shown with TP14 tray and BEE312 and BEE317 shakers



Shown with 3218 wood peel and BEE319 shakers

BUS309

BUS312

### Round Pizza Stands

**SDRCK4** 7 1/2" Top Dia. x 9 5/8" Bottom Dia. x 4" H (19.1 x 24.4 x 10.2 cm)

**SDRCK** 7 1/2" Top Dia. x 9 5/8" Bottom Dia. x 7 3/8" H (19.1 x 24.4 x 18.7 cm)

### Universal Pizza Stands

#### Black

**BUS309** 9" L x 8" W x 7" H (22.9 x 20.3 x 17.8 cm)

**BUS312** 12" Sq. x 7" H (30.5 x 17.8 cm)

#### Chrome-Plated

**190039** 9" L x 8" W x 7" H (22.9 x 20.3 x 17.8 cm)

**1900312** 12" Sq. x 7" H (30.5 x 17.8 cm) (not shown)



190039 shown with HC5016 pan



Shown with PC7400  
pizza cutter and  
4407 shaker

LWUS779

LWUSR shown with TP12 pan

SSUS1

### Contempo™ Swirl Pizza Stands

These stylishly versatile stands can be flipped over to accommodate different sizes of trays.

- LWUSR** Red  
7" Top Dia. x 9" Bottom Dia. x 6 3/8" H  
(17.8 x 22.9 x 16.2 cm)
- LWUS779** Black  
7 1/8" Top Dia. x 9" Bottom Dia. x 7" H  
(18.1 x 22.9 x 17.8 cm)
- SSUS1** Stainless Steel  
7 1/4" Top Dia. x 9" Bottom Dia. x 6 3/4" H  
(18.4 x 22.9 x 17.1 cm)

### Geometric Pizza Stands

Pizzas are center of the stage when served on our Geometric Pizza Stands. Available in multiple color options, these 7" stands can be paired with any one of our many wood boards or peels to create a truly showstopping look.

- RGS7** Stainless Steel  
7" Dia. x 7" H (17.8 x 17.8 cm)
- RGG7** Gold  
7" Dia. x 7" H (17.8 x 17.8 cm)
- RGB7** Black  
7" Dia. x 7" H (17.8 x 17.8 cm)

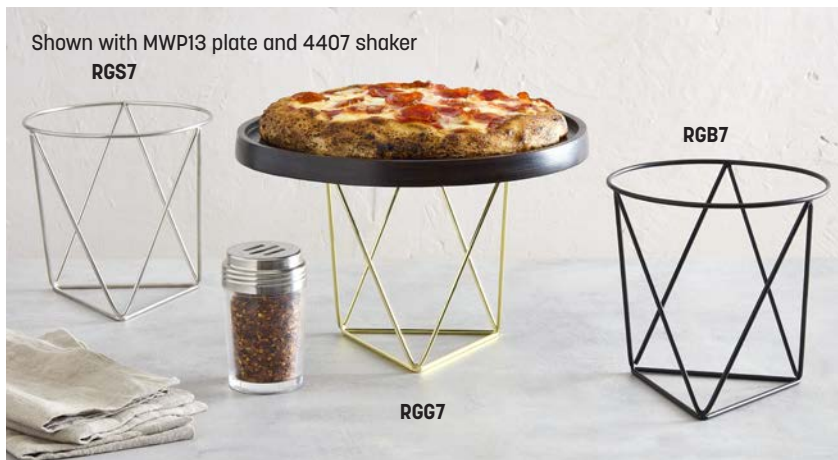

Shown with MWP13 plate and 4407 shaker

RGS7

RGB7

RGG7

### Shaker Caddy Attachments

Ingeniously transport and serve cheese and spice options for every pizza with our expertly designed Shaker Caddy Attachments. Designed to fit on the bottom of many popular pizza stands, these attachments will hold most 6 to 12 oz. shakers. These essential accessories turn any pizza stand into a shaker caddy!

- SCAR9** Rectangular Attachment  
9 5/8" L x 3 1/2" W x 2 3/8" H  
(24.4 x 8.9 x 6 cm)  
Fits Stands 190039, RSB312, RSRB7  
Holds most 6 oz. (177.4 mL) to  
12 oz. (354.9 mL) Shakers
- SCAT9** Triangular Attachment  
9 1/4" L x 8 1/4" W x 1 3/4" H  
(23.5 x 21 x 4.4 cm)  
Fits Stands SDRCK, RSRB, RSR10  
Holds most 6 oz. (177.4 mL) to  
12 oz. (354.9 mL) Shakers



SCAR9 shown with 190039 stand  
and GLA312, GLA317 shakers

SCAT9 shown with SDRCK stand  
and 3308, 3309 shakers

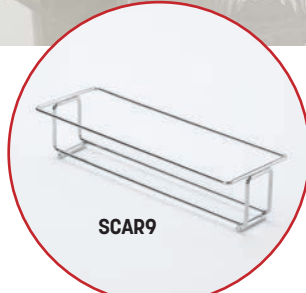

SCAR9



SCAT9





## Loft Collection Rubberized

### Hairpin Stands

The newest additions to our black rubberized stands, these risers boast unique hairpin curved legs with an added rubberized texture to keep things in place. No more sliding pizzas!

**RSRBH4** 9" Dia. x 4" H (22.9 x 10.2 cm)

**RSRBH7** 9" Dia. x 7" H (22.9 x 17.8 cm)

RSRBH7

RSRBH4

### Rubberized Universal Stands

Our stylishly minimalist pizza stands, now wrapped in slide-resistant rubber. What's not to love?

#### Red

**RSR312** 9" L x 8 3/4" W x 7" H (22.9 x 22.2 x 17.8 cm)

**RSR307** 12" Sq. x 7" H (30.5 x 17.8 cm)

#### Black

**RSR312** 9" L x 8 3/4" W x 7" H (22.9 x 22.2 x 17.8 cm)

**RSR307** 12" Sq. x 7" H (30.5 x 17.8 cm)

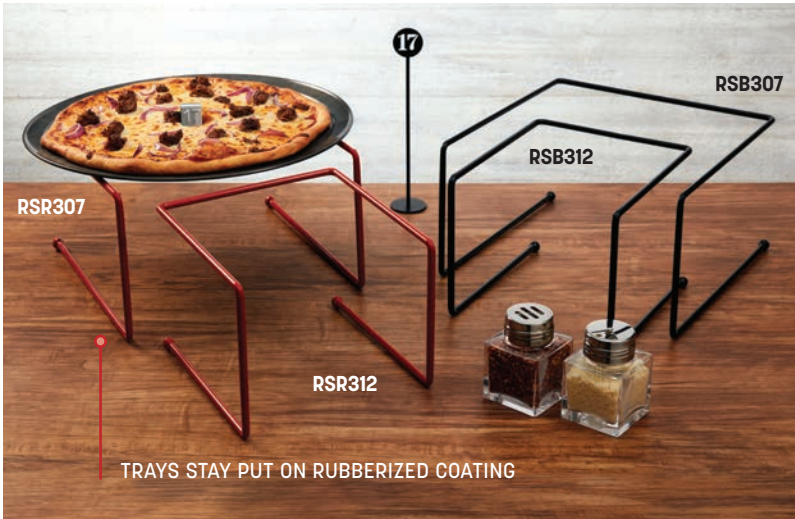

RSR307

RSB307

RSR312

RSR312

TRAYS STAY PUT ON RUBBERIZED COATING

### Black Rubberized Stands

Tired of tracking down rubber stoppers to keep your pizza pans in place? These ingenious stands have the rubber built in. Plus, each of these contemporary wire-frame designs are reversible.

#### Round

**RSRB4** 7 1/2" Dia. Top x 9 5/8" Bottom Dia. x 4" H (19.1 x 24.4 x 10.2 cm)

**RSRB** 7 1/2" Dia. Top x 9 5/8" Bottom Dia. x 7 3/8" H (19.1 x 24.4 x 18.7 cm)

**RSR10** 8 3/8" Dia. Top x 9 7/8" Bottom Dia. x 11 3/4" H (21.3 x 25.1 x 29.8 cm)

#### Rectangular

**RSRB3** 9" L x 6" W Top x 11" L x 8" W Bottom x 3 1/2" H (22.9 x 15.2 x 27.9 x 20.3 x 8.9 cm)

**RSRB7** 9" L x 6" W Top x 11" L x 8" W Bottom x 7" H (22.9 x 15.2 x 27.9 x 20.3 x 17.8 cm)

#### Square

**RSSB3** 7" Sq. Top x 9" Sq. Bottom x 3 1/2" H (17.8 x 22.9 x 8.9 cm)

**RSSB7** 7" Sq. Top x 9" Sq. Bottom x 7" H (17.8 x 22.9 x 17.8 cm)



RSR10

RSRB

RSRB4

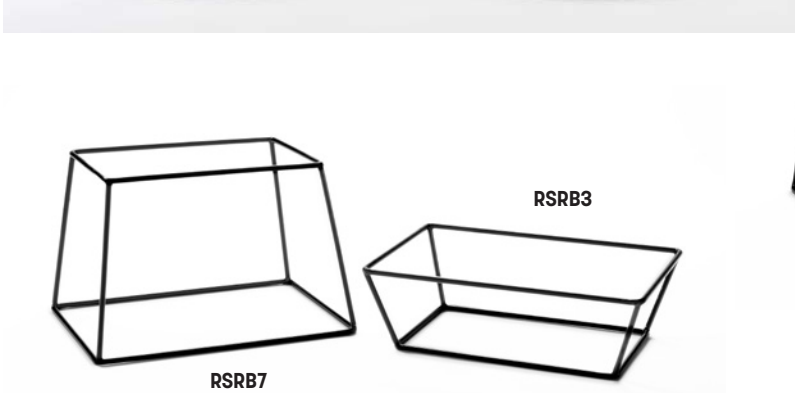

RSRB7

RSRB3

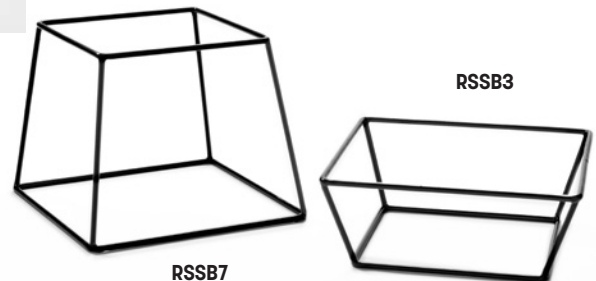

RSSB7

RSSB3

**Loft Collection Rustic Iron Stand**  

Finally a pizza stand equally as cool as the pizzas it displays. Made of black iron with a rustic finish, this 7" high stand stylishly saves space on the table while allowing space for condiments underneath. Pair with your favorite wood serving board from the Loft Collection to complete the vibe.

**PSR7** 9" Dia. x 7" H  
(22.9 x 17.8 cm)

**Ironworks Pizza Stands** 

**DPS797** Drum  
7" Top Dia. x 9" Bottom Dia. x 7" H  
(17.8 x 22.9 x 17.8 cm)

**PSS77** Black Square Scroll  
7" Sq. x 9" H (17.8 x 22.9 cm)

**Black Iron Pizza Stand** 

Serve two pizzas at a time without taking up valuable table space with this two-tiered piece from our Ironworks Collection.

**TLSP1219** 19 3/8" L x 11 3/4" W x 12 3/8" H  
(49.2 x 29.8 x 31.4 cm)



Shown with ATP14 serving board

**PSR7**



**PSS77** shown with HA5012 pan

**DPS797** shown with TP14 pan



DESIGNED FOR MINIMAL FOOTPRINT

**TLSP1219** shown with TP15 pan





## Heavy-Duty Pizza Servers

Pizza anyone? These heavy-duty stainless steel servers are able to stand up to your largest slice. The perforated server even doubles as a cheese grater for a little extra topping.

- PSG127** Perforated Server/Grater  
7" L x 4 3/4" W Blade, 12 1/8" L Overall  
(17.8 x 12.1, 30.8 cm)
- PS127** Server  
7" L x 4 3/4" W Blade, 12 1/8" L Overall  
(17.8 x 12.1, 30.8 cm)

## Mini Pizza Peels

The ideal size for personal pizzas and oven-baked subs. These heavy-duty stainless steel peels are strong enough to hold your heaviest pie. Perfect for conveyor ovens.

- PL147** Stainless Steel  
7 1/4" W x 9 5/8" L Blade, 14 3/4" L Overall  
(18.4 x 24.4, 37.5 cm)
- PLP147** Perforated Stainless Steel  
7 1/4" W x 9 5/8" L Blade, 14 3/4" L Overall  
(18.4 x 24.4, 37.5 cm)



## Pizza Scissors/Turner

Pizza-lovers, rejoice! These innovative server-scissors can both cut and serve even the heartiest deep-dish pies. With a rubberized handle for comfortable grip and detachable construction for easy cleaning, this is a must-have tool for pizzerias across the globe.

- PSD10** 10 5/8" L x 3 1/2" W x 3/4" H  
(27 x 8.9 x 1.9 cm)

## Pizza Servers

Each of these practical tools features a stainless steel blade, perfect for both square- and triangle-sliced pizzas.

- 19006** Stainless Steel Pizza Server with Wood Handle  
5" L x 2 1/2" W Blade, 10 1/2" Overall  
(12.7 x 6.4, 26.7 cm)
- PS10** Stainless Steel Turner with Plastic Handle  
3 5/8" L x 1 7/8" W Blade, 10" Overall  
(9.2 x 4.8, 25.4 cm)
- PS196** Stainless Steel Pizza Server with Dark Brown Handle  
5" L x 2 1/2" W Blade, 10 1/2" Overall  
(12.7 x 6.4, 26.7 cm)



### Plastic-Handled Pizza Cutters

Heavy-duty one-piece molded plastic handles, stainless steel wheels.

**PPC2** 2 ¾" Dia. Wheel with Black Handle (7 cm)

**PCW2** Blade for PPC2

**PPC4** 4" Dia. Wheel with Black Handle (10.2 cm)

**PIZW1** 4" Dia. Wheel with White Handle (10.2 cm)

**PIZR2** 4" Dia. Wheel with Red Handle (10.2 cm)

**PIZG3** 4" Dia. Wheel with Green Handle (10.2 cm)

**PCW4** Blade for PPC4, PIZW1, PIZR2, PIZG3

**PPC5** 5" Dia. Wheel with Black Handle (12.7 cm)

**PCW5** Blade for PPC5

**PPCHARDWARE** Replacement Axle Assembly, with Screw Bushing and Lock Nut



### Aluminum-Handled Pizza Cutter

Simple and classic, this cutter features a heavy cast aluminum handle with a stainless steel wheel.

**APC2** 2 ¾" Dia. Wheel (6.7 cm)



### Wood-Handled Pizza Cutters

Features sanitary stainless steel wheels, rust-proof guards and wooden handles.

**PC7250** 2 ½" Dia. Wheel (6.4 cm)

**PC7400** 4" Dia. Wheel (10.2 cm)



### Loft Collection Acacia Wood-Handled Accessories

Pizza serving utensils that now offer form, function and beauty. The Loft Collection pizza cutter and server are designed to sit proudly on the table with their beautiful Acacia wood handles and durable stainless steel finish.

#### Pizza Cutter

**PCA3** 3 ½" Dia. Wheel (8.9 cm)

#### Pizza Server

**PSA105** 5 ½" L x 2 ¾" W Blade, 10 ¾" Overall (14 x 6, 27.3 cm)







### Pizza Knives

These full-tang knives feature stainless steel blades and double handles so you can cut safely and confidently.

**PPK17** POM Handle  
18" L Blade (45.7 cm)

**PWK19** Wood Handle  
18" L Blade (45.7 cm)

### Pizza Rocker Knives

In addition to cutting pizzas, these stainless steel blades can be used to chop ingredients.

**PRS14** 13 3/4" L x 3 1/2" H (34.9 x 8.9 cm)

**PRS22** 22" L x 5 1/8" H (55.9 x 13 cm)

**PKR20** 20" L x 4 3/4" H Blade  
21 1/2" L Overall with Handles  
(50.8 x 12.1, 54.6 cm)

### Multi-Wheel Cutter

Take the guesswork out of slicing with this adjustable six-bladed cutter. Measures 2 1/2" x 9 1/2" (6.4 x 24.1 cm) when closed, and 24 1/2" x 9 1/2" (62.2 x 24.1 cm) when open. Distance between 2" parallel wheels can range from 3/4" to 4 3/4" (1.9 x 12.1 cm).

**MWPC6X2** Six-Blade Cutter



**MWPC6X2**

ALSO USEFUL FOR EVENLY SLICING PASTRY DOUGH

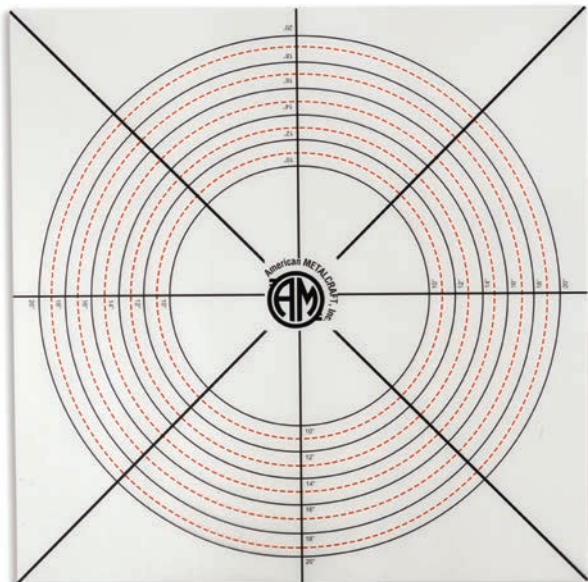

MPNS



MPCUT4

### Non-Slip Pizza Cutting Mat

**MPNS** 22" Sq. x 1/8" H (55.9 x 0.32 cm)

### Pizza Slice Cutting Guide

Made of natural pressed wood fiber material, these durable and dishwasher-safe cutting boards have laser-cut grooves that make cutting evenly-sized pizza slices a breeze.

**MPCUT4** Board with Markings for 4-Slice or 8-Slice  
20" Sq. x 1/4" H (50.8 x 0.6 cm)

**MPCUT6** Board with Markings for 6-Slice  
20" Sq. x 1/4" H (50.8 x 0.6 cm)  
(not shown)

### Pizza Bubble Poppers

Choose from wood, all-aluminum and red rubber grips.

**SBP30** Red Rubber Grip  
30" L (76.2 cm)

**BP39** Wood Handle  
39" L (99 cm)

**19009** Aluminum  
43" L (109.2 cm)

**BP51** Wood Handle  
51" L (129.5 cm)

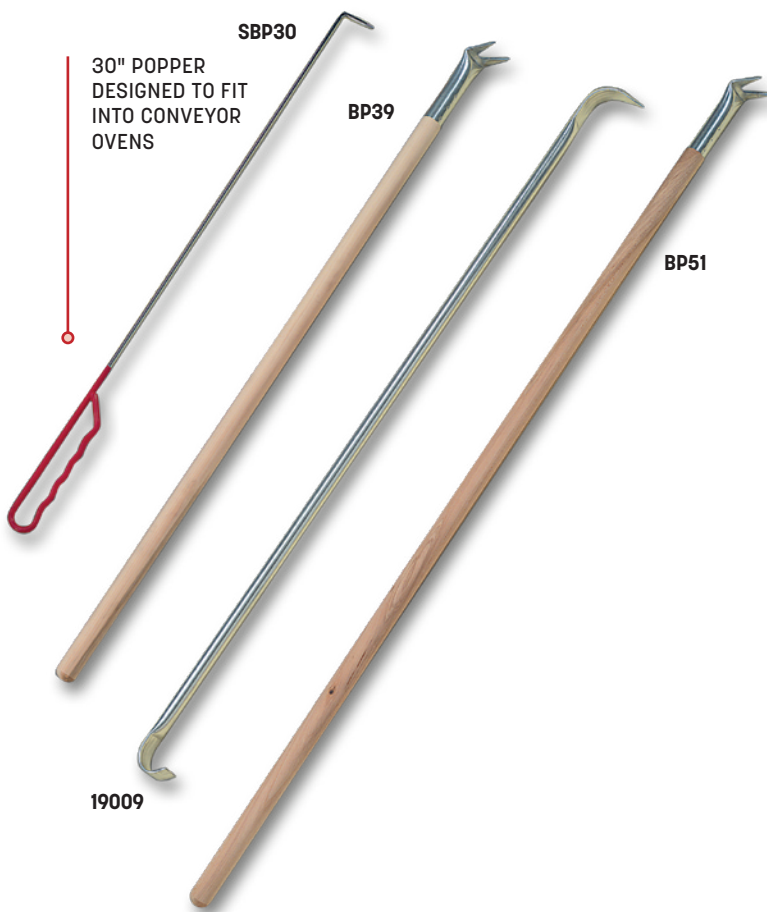





**19029**  
shown with  
HCDEP12 and  
TP12 pans

**19030**  
shown with  
ADEP12 and  
HCDEP12 pans

**19033**  
shown with  
HC90182 and  
HA2018 pans

**19024**  
shown with  
18712, and  
18717 pizza  
screens



**19107**

Shown with (3)  
18714 pizza screens

### Pizza Racks

**19030** Standard for Pans up to 2 ¼" (5.7 cm) Deep  
10" - 17" (25.4 - 43.2 cm) Dia.  
11 Shelves with 2 ½" (6.4 cm) between with 12" (30.5 cm) Base

**19029** Standard for Pans up to 1 ¼" (3.2 cm) Deep  
10" - 17" (25.4 - 43.2 cm) Dia.  
15 Shelves with 1 ⅜" (3.5 cm) between with 12" (30.5 cm) Base

**19024** Standard for Pans up to ½" (1.5 cm) Deep  
10" - 17" (25.4 - 43.2 cm) Dia.  
24 Shelves with ¾" (1.9 cm) between with 12" (30.5 cm) Base

**19033** Over Sized for Pans up to 2 ¼" (5.7 cm) Deep  
16" - 23" (40.6 - 58.4 cm) Dia.  
10 Shelves with 2 ½" (6.4 cm) between with 16" (40.6 cm) Base

### Wall-Mounted Pizza Rack

**19107** Wall-Mountable with Seven Tiers  
12" L x 10" W x 15" H  
(30.5 x 25.4 x 38.1 cm)

**19104** 4 Brackets and 8 Screws for 19107

**Deluxe Small All-Aluminum Peels** 

12" (30.5 cm) Square Blade

- ITP1213 27" Overall (68.6 cm)
- ITP1222 37" Overall (94 cm)
- ITP1238 52" Overall (132.1 cm)
- ITP1246 60" Overall (152.4 cm)

**Deluxe Medium All-Aluminum Peels** 

14 1/2" (36.8 cm) Square Blade

- ITP1413 30" Overall (76.2 cm)
- ITP1422 39" Overall (99.1 cm)
- ITP1438 55 1/2" Overall (141 cm)
- ITP1446 63 1/2" Overall (161.3 cm)

**Deluxe Large All-Aluminum Peels** 

17 1/2" x 18 1/2" (44.5 x 47 cm) Blade

- ITP1713 34" Overall (86.4 cm)
- ITP1722 43" Overall (109.2 cm)
- ITP1738 59 1/2" Overall (151.1 cm)
- ITP1746 68" Overall (172.7 cm)

**Deluxe Extra Large All-Aluminum Peels** 

19 1/2" x 21" (49.5 x 53.3 cm) Blade

- ITP1913 37" Overall (94 cm)
- ITP1922 45 1/2" Overall (115.6 cm)
- ITP1938 62" Overall (157.5 cm)
- ITP1946 67 3/4" Overall (172.1 cm)

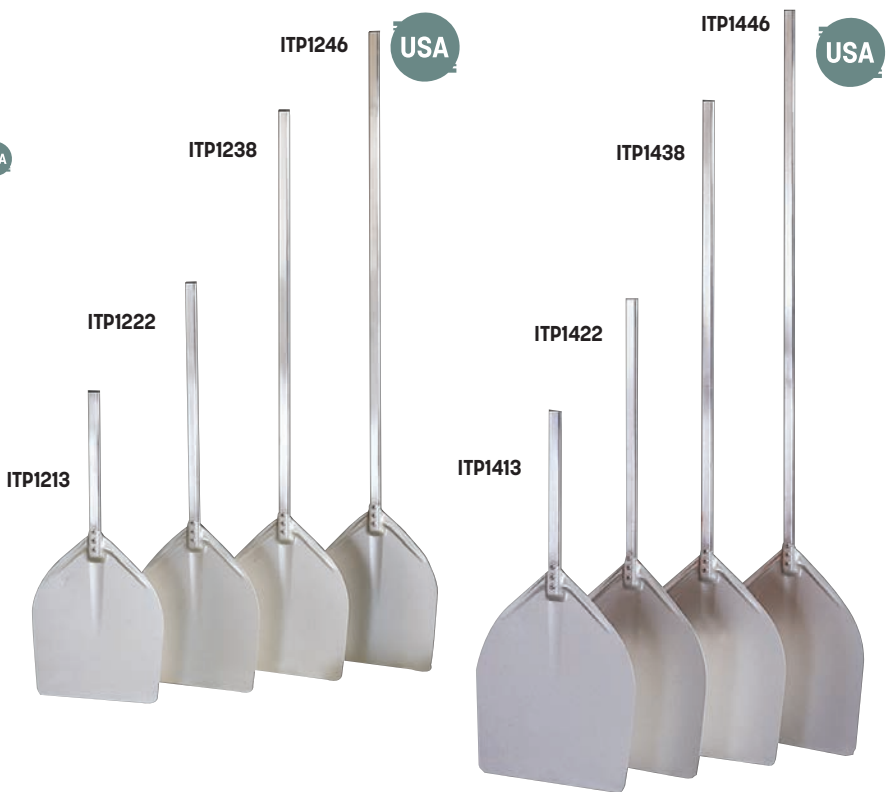





### Aluminum Small Blade Peels

9" x 11" (22.9 x 28 cm) Blade

- 2109** 21" L Overall (53.3 cm)
- 3209** 32 ½" L Overall (82.6 cm)
- 4909** 49" L Overall (124.5 cm)
- 6109** 61" L Overall (155 cm)

### Aluminum Medium Blade Peels

12" x 14" (30.5 x 35.6 cm) Blade

- 2512** 26" L Overall (66 cm)
- 3512** 35 ½" L Overall (90.2 cm)
- 5212** 52" L Overall (132.1 cm)
- 6412** 64" L Overall (162.6 cm)

### Aluminum Large Blade Peels

14" x 16" (35.6 x 40.6 cm) Blade

- 2814** 28" L Overall (71.1 cm)
- 3714** 37" L Overall (94 cm)
- 5414** 54" L Overall (137.2 cm)
- 6614** 66" L Overall (167.6 cm)

### Aluminum Extra Large Blade Peels

16" x 18" (40.6 x 45.7 cm) Blade

- 3016** 30" L Overall (76.2 cm)
- 4016** 39 ½" L Overall (100.3 cm)
- 5616** 56" L Overall (142.2 cm)
- 6816** 68" L Overall (172.7 cm)

### Aluminum Round Blade Peels

17080 8" Dia. x 20" L Blade Overall (20.3 x 50.8 cm)

17135 13 ½" Dia. x 35" L Blade Overall (34.3 x 88.9 cm)

17160 16" Dia. x 38" L Blade Overall (40.6 x 96.5 cm)

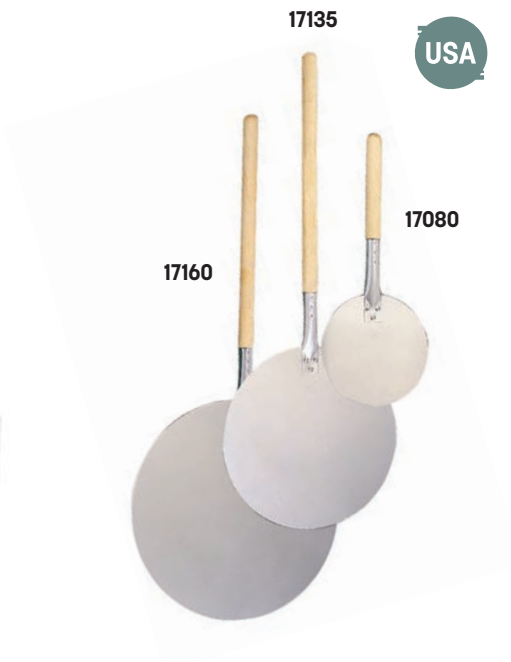

Perf P For pricing, visit [amnow.com](http://amnow.com)

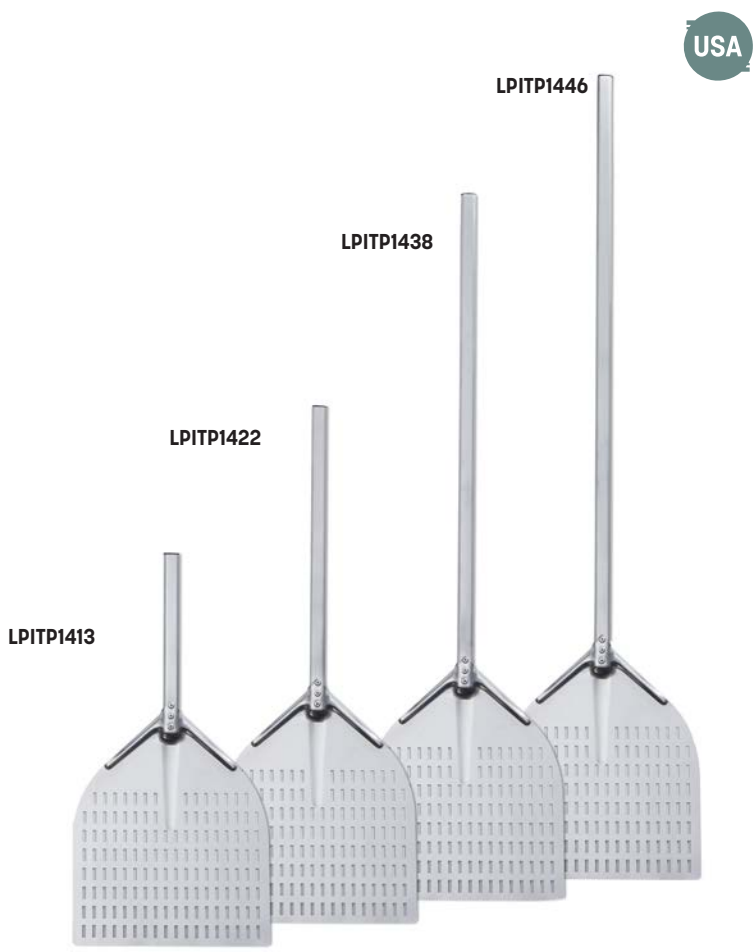
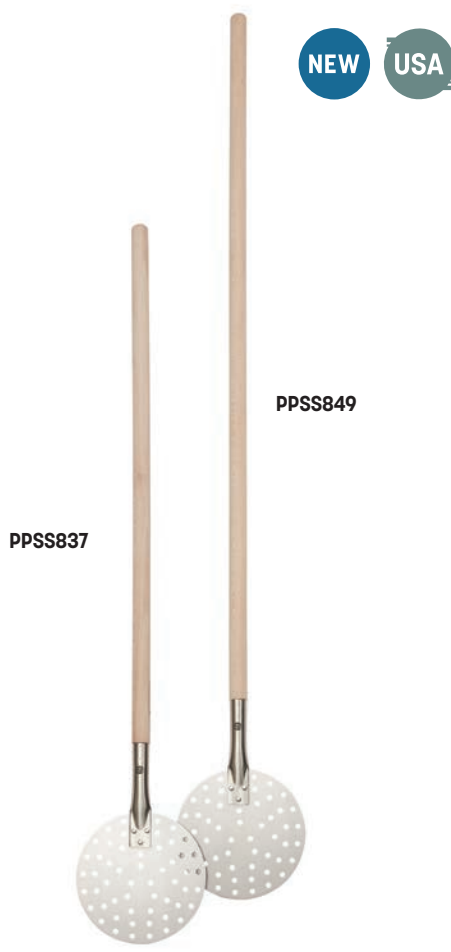

**Stainless Steel Perforated Pizza Peels** NEW USA

Perfect for high heat ovens, these perforated pizza peels make it easy to move pizzas in, out and around ovens. The perforations reduce resistance and weight, allowing for even quicker transfers. Available in multiple long handle lengths. 8" (20.3 cm) Diameter Blade.

- PPSS837** 45 3/4" L Overall (116.2 cm)
- PPSS849** 57 3/4" L Overall (146.7 cm)

**Linear Perforated All-Aluminum Pizza Peels** USA

Safely move pizzas in and around a piping hot oven. Linear perforation helps with easier transfer. 14 1/2" (36.8 cm) Square Blade.

- LPITP1413** 30" L Overall (76.2 cm)
- LPITP1422** 39" L Overall (99.1 cm)
- LPITP1438** 55 1/2" L Overall (141 cm)
- LPITP1446** 63 1/2" L Overall (161.3 cm)

**Small All-Aluminum Peel** USA

- 674** Blade  
6 3/4" x 7 3/4", 20 1/2" L Overall  
(17.1 x 19.7, 52.1 cm)



**Chrome-on-Steel Peel Rack** USA

- WPH45153** 4 5/8" W x 1 1/4" D x 3" H  
(11.7 x 3.2 x 7.6 cm)





**Deluxe Wood Make-Up Peel** 

**32" L (81.3 cm) Overall**

3218 Blade 18" W x 17 1/2" L (45.7 x 44.5 cm)

**Deluxe Wood Blade** 

**36" L (91.4 cm) Overall**

3612 Blade 12" W x 13" L (30.5 x 33 cm)

3614 Blade 14" W x 15" L (35.6 x 38.1 cm)

3616 Blade 16" W x 17" L (40.6 x 43.2 cm)

**42" L (106.7 cm) Overall**

4212 Blade 12" W x 13" L (30.5 x 33 cm)

4214 Blade 14" W x 15" L (35.6 x 38.1 cm)

4216 Blade 16" W x 17" L (40.6 x 43.2 cm)

4218 Blade 18" W x 18" L (45.7 x 45.7 cm)

4220 Blade 20" W x 21" L (50.8 x 53.3 cm)





### Caring for Wood Peels

Want to keep your wood peel looking fresh? Always wipe it clean with a damp cloth. Never put in dishwasher, soak in water, place under a heat lamp or leave on a hot surface. If your peel warps, leave it with the warp facing up overnight and it should flatten out.

### Deluxe Wood Blade Short Handle

- 814 8" W x 9" L Blade, 14" L Overall  
(20.3 x 22.9, 35.6 cm)
- 2212 12" W x 13" L Blade, 22" L Overall  
(30.5 x 33, 55.9 cm)
- 2414 14" W x 15" L Blade, 24" L Overall  
(35.6 x 38.1, 60.1 cm)
- 2616 16" W x 17" L Blade, 26" L Overall  
(40.6 x 43.2, 66 cm)

### Deluxe Wood Square Blade – 39" L (99.1 cm) Overall

- 1139 Blade, 11" Sq. (27.9 cm)

### Deluxe Wood Long Blade – 6 1/2" L (16.5 cm) Handle

#### 36" L (91.4 cm) Overall

- 836 Blade 8" W x 29 1/2" L (20.3 x 74.9 cm)
- 1636 Blade 16" W x 29 1/2" L (40.6 x 74.9 cm)
- 1836 Blade 18" W x 29 1/2" L (45.7 x 74.9 cm)

#### 42" L (106.7 cm) Overall

- 1842 Blade 18" W x 36" L (45.7 x 91.4 cm)
- 2242 Blade 22" W x 36" L (55.9 x 91.4 cm)

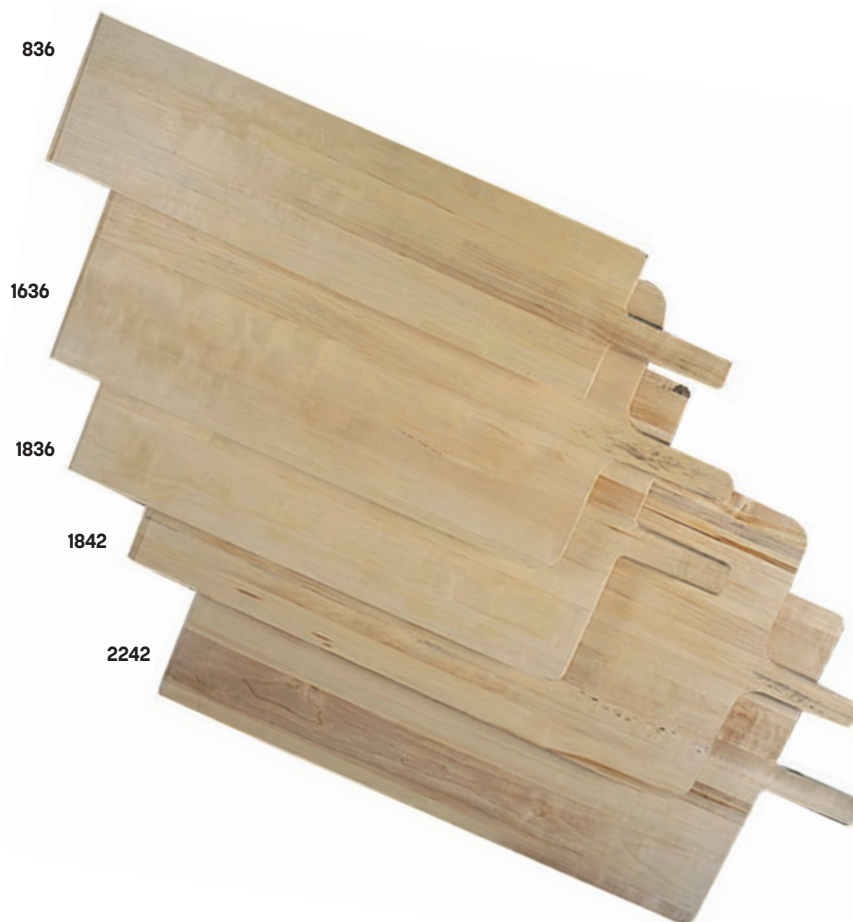



Shown with RSRBH7 and RSRBH4 stands



ATP14

ATP12

ATP16

SERVING BOARDS  
ARE REVERSIBLE

ATP10



OWP17

OWP15

OWP13

OWP9

### Loft Collection Acacia Wood Serving Boards

Plate up anything from pizzas to charcuterie in these beautifully grained wood boards. Made of durable Acacia wood, each board is double-sided for versatility in serving. Pair with risers and accessories from the Loft Collection for a complete look.

**ATP10** 10" Dia. x 5/8" H (25.4 x 1.6 cm)

**ATP12** 12" Dia. x 5/8" H (30.5 x 1.6 cm)

**ATP14** 14" Dia. x 5/8" H (35.6 x 1.6 cm)

**ATP16** 16" Dia. x 5/8" H (40.6 x 1.6 cm)

### Short Handle Olive Wood Serving Peels

Featuring rich wood grains, our olive wood boards and peels give any tabletop an extra dimension. These pieces are exceptionally unique—no two are alike.

**OWP9** 8" W x 9" L Blade, 14" Overall  
(20.3 x 22.9, 35.6 cm)

**OWP13** 12" W x 13" L Blade, 22" Overall  
(30.5 x 33, 55.9 cm)

**OWP15** 14" W x 15" L Blade, 24" Overall  
(35.6 x 38.1, 61 cm)

**OWP17** 16" W x 17" L Blade, 26" Overall  
(40.6 x 43.2, 66 cm)

### Maple Pressed Wood

#### Serving Boards USA

A beautiful maple veneer gives these boards the look and feel of wood, but with the ease of being dishwasher-safe.

**MBSB11** 11" L x 7" W x ¼" H  
(27.9 x 17.8 x 0.6 cm)

**MBSB17** 17" L x 9" W x ¼" H  
(43.2 x 22.9 x 0.6 cm)

**MBSB20** 19" L x 9" W x ¼" H  
(48.3 x 22.9 x 0.6 cm)

### Black Pressed Wood

#### Serving Boards

Made of natural wood fiber material, this black serving board is the perfect companion to our Mega Flatbread Screens

**MPSB16** 16" L x 8" W x ¼" H  
(40.6 x 20.3 x 0.6 cm)







USA

MBM4 shown with GJ6 jar



USA

**Maple Pressed Wood  
Serving Peels**

USA

These presentation-worthy peels feature a beautiful maple veneer that's both food- and dishwasher-safe. Though we designed them for pizzas, they can also be used to serve appetizers, sandwiches and more.

**Rectangular**

- MBM2** 12 1/2" L x 4 3/8" W x 1/4" H, 18" L Overall (31.8 x 11.1 x 0.6, 45.7 cm)
- MBM3** 12 1/2" L x 6 1/2" W x 1/4" H, 18" L Overall (31.8 x 16.5 x 0.6, 45.7 cm)
- MBM4** 13" L x 8 1/8" W x 1/4" H, 18" L Overall (33 x 20.6 x 0.6, 45.7 cm)

**Round**

- MBM180** 18" Dia. x 1/4" H, 28 1/2" L Overall (45.7 x 0.6, 72.4 cm)



USA

MBM180

### PRESSED WOOD PEELS

Made of natural wood fiber material, these durable, dishwasher-safe pressed wood peels overcome the objections health departments may have with traditional wood peels and boards.

#### Round Pressed Wood Pizza Peels 5" L (12.7 cm) Handle

- MP1116 11" Dia. (27.9 cm)
- MP1217 12" Dia. (30.5 cm)
- MP1318 13" Dia. (33 cm)
- MP1419 14" Dia. (35.6 cm)
- MP1520 15" Dia. (38.1 cm)
- MP1621 16" Dia. (40.6 cm)
- MP1722 17" Dia. (43.2 cm)
- MP1823 18" Dia. (45.7 cm)



MP1116

#### Pressed Wood Pizza Peels

- MP1222 Blade  
12" L x 14" W, 22" L with Handle  
(30.5 x 35.6, 55.9 cm)
- MP1424 Blade  
14" L x 16" W, 24" L with Handle  
(35.6 x 40.6, 61 cm)
- MP1626 Blade  
16" L x 17" W, 26" L with Handle  
(40.6 x 43.2, 66 cm)



MP1116 MP1318 MP1520 MP1722  
MP1217 MP1419 MP1621 MP1823

#### Make-Up Pressed Wood Pizza Peel

- MP1826 18" Sq. Blade, 26" L with Handle  
(45.7, 66 cm)



MP1826

USA



MP1424

MP1222

MP1626





**BLDX2005**

**BLDX1805**



**BLB1914**

**BLB1926**

### Deluxe Pizza Delivery Bags

With the golden age of food delivery upon us, we're proud to present our most advanced pizza bags to date. Featuring durable, abrasion- and mildew-resistant material and superior insulation. Plus, they're easy to clean.

- BLDX1805** 18" Sq. x 5" H  
(45.7 x 12.7 cm)  
Holds (2) 16" (40.6 cm) Pizza Boxes
- BLDX2005** 20" Sq. x 5" H  
(50.8 x 12.7 cm)  
Holds (2) 18" (45.7 cm) Pizza Boxes

### Deluxe Delivery Bags with Rack

Features heavy-duty crossing straps for comfortable carrying. Perfect for carrying multiple pizzas.

#### With Rack

- BLB1914** 19 ½" Sq. x 14 ½" H  
(49.5 x 36.8 cm)  
Holds up to 6 Pizza Boxes
- BLB1926** 19" Sq. x 27" H  
(48.3 x 68.6 cm)  
Holds up to 10 Pizza Boxes

#### Bag Only

- BLBAG19** 19 ½" Sq. x 14 ½" H  
(49.5 x 36.8 cm)  
Holds up to 6 Pizza Boxes
- BLBAG26** 19" Sq. x 27" H  
(48.3 x 68.6 cm)  
Holds up to 10 Pizza Boxes



### Deluxe Delivery Bags

These bags feature rust-proof iron grommets for steam ventilation. The perfect sizes for carry out containers and even grocery delivery.

**BLDB1212** 12 ½" Sq. x 12" H  
(31.8 x 30.5 cm)

**BLDB2412** 24 ¾" L x 12 ½" W x 12" H  
(62.9 x 31.8 x 30.5 cm)

### Deluxe Sandwich Delivery Bag

This bag features rust-proof iron grommets for steam ventilation.

**BLSB1512** 15" L x 9" W x 12" H  
(38.1 x 22.9 x 30.5 cm)



### Deluxe Catering Delivery Bag

This satchel fits both full- and half-size food pans, making it the prime solution for delivering pastas, salads and other family-style feasts. Features easy-carry straps and an insulated interior as well as adjustable shelves and a reinforced frame.

**BLDB2216** 22" L x 13" W x 16" H  
(55.9 x 33 x 40.6 cm)







## Pizza Delivery Bags

With heavy nylon construction and reinforced stitching, these durable bags can hold two pizza boxes at a time. Contains PVC foam to keep pies oven-fresh.

- PBDX1805** 18" Sq. x 5" H  
(45.7 x 12.7 cm)  
Holds (2) 16" (40.6 cm) Pizza Boxes
- PBDX2005** 20" Sq. x 5" H  
(50.8 x 12.7 cm)  
Holds (2) 18" (45.7 cm) Pizza Boxes

## Delivery Bags with Rack

The heavy nylon construction, reinforced stitching and insulating PVC foam from our Pizza Delivery Bags, supersized. Includes racks and features a two-handled strap for carrying.

### With Rack

- PB1914** 19 1/2" Sq. x 14 1/2" H  
(49.5 x 36.8 cm)  
Holds up to 6 Pizza Boxes
- PB1926** 19" Sq. x 27" H  
(48.3 x 68.6 cm)  
Holds up to 10 Pizza Boxes

### Bag Only

- PBBAG19** 19 1/2" Sq. x 14 1/2" H  
(49.5 x 36.8 cm)  
Holds up to 6 Pizza Boxes
- PBBAG26** 19" Sq. x 27" H  
(48.3 x 68.6 cm)  
Holds up to 10 Pizza Boxes



## Sandwich Delivery Bag

Nine tiny grommet holes let this bag breathe, making it ideal for sandwich deliveries or picnics.

- PBSB1512** 15" L x 9" W x 12" H  
(38.1 x 22.9 x 30.5 cm)



## Stirring Paddles

### Stainless Steel Paddles

These seamless stainless steel paddles feature a 4 3/4" x 9 3/4" (12.1 x 24.8 cm) blade and 1" (2.5 cm) wide tubular handle. Available in multiple lengths.

- 2124 24" L (61 cm)
- 2130 30" L (76.2 cm)  
(not shown)
- 2136 36" L (91.4 cm)  
(not shown)
- 2142 42" L (106.7 cm)  
(not shown)
- 2148 48" L (121.9 cm)  
(not shown)
- 2154 54" L (137.2 cm)  
(not shown)

### Hard Wood Stirring Paddles

Smooth-sanded hardwood with a rectangular tapered blade. Blade measures 4" wide x 7/8" thick (10.2 x 2.2 cm). Handles measure 1 1/4" (3.2 cm) wide and are available in multiple lengths.

- 240 24" L (61 cm)
- 300 30" L (76.2 cm)  
(not shown)
- 360 36" L (91.4 cm)  
(not shown)
- 420 42" L (106.7 cm)  
(not shown)
- 480 48" L (121.9 cm)  
(not shown)



## Pizza Oven Brush with Brass Bristles and Steel Scraper

Heavily filled (65 tufts) stiff brass wire on one side and a rust-proof steel scraper on the other. Screw-on handle with extra-strong die cast aluminum threaded tip for easy attachment to 10" x 1 3/4" (25.4 x 4.4 cm) hardwood block.

- 1597 Complete Brush and 40" Handle (101.6 cm)
- 1698 Complete Brush and 60" Handle (152.4 cm)
- 1597H Replacement Brush Only
- 159740 Handle Only 40" (101.6 cm)
- 159760 Handle Only 60" (152.4 cm)

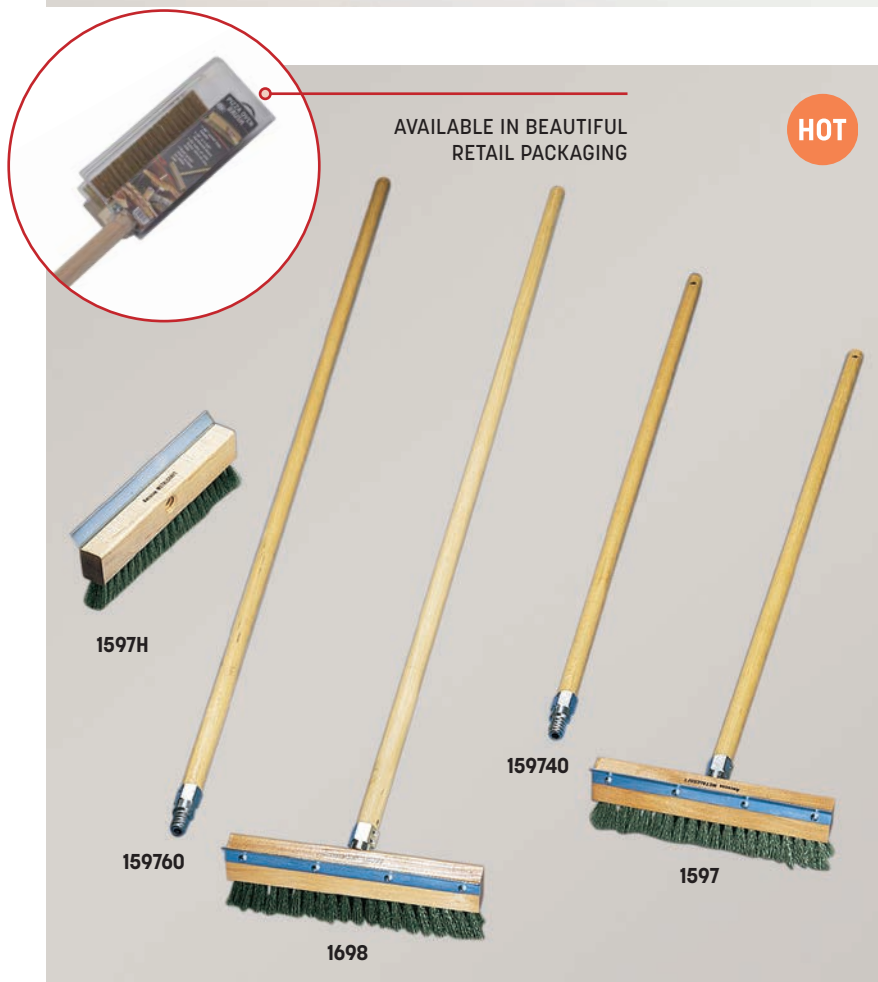



**IS13** shown with three  
MWME21 platters



**IS18** shown with three  
MEL19 platters



### Pairing Suggestions for Creative Presentations

Throughout the catalog, we pair various bowls, trays, platters and baskets in wood, bamboo, ceramic, porcelain, melamine, glass and stainless steel with our stands and risers. We even have flight boards that fit glass bottles. Please use the list below to make your own pairings for gorgeous, one-of-a-kind presentations.

**TTREC3** shown with  
three MEL19 platters



### RECTANGULAR & SQUARE STANDS

#### IS13 Stand Fits

AWMEL21.....	216
BAM211.....	246
BAM22.....	246
BG2113.....	207
CER21.....	199
CRGT21.....	208
FSLT21.....	231
FSLW21.....	230
FSMEL21.....	232
HMRT1322.....	265
MEL21.....	215
MEL2113.....	214
MWMEL21.....	233
WMEL21.....	242

#### IS18 Stand Fits

AWMEL19.....	216
BAM14.....	246
BAM148.....	246
BG159.....	207
CER19.....	199
CRGT21.....	208
FSLT08.....	231
FSLW08.....	230
FSMEL19.....	232
HMRT814.....	265
MEL148.....	214
MEL19.....	215
MWMEL19.....	233
RTWVY1.....	199
WMEL19.....	242

#### TTREC3 Stand Fits

AWMEL19.....	216
BAM14.....	246
BAM148.....	246
BG159.....	207
CER19.....	199
CRGT21.....	208
FSLT08.....	231
FSLW08.....	230
FSMEL19.....	232
HMRT814.....	265
MEL148.....	214
MEL19.....	215
MWMEL19.....	233
RTWVY1.....	199
WMEL19.....	242

### ROUND STANDS

#### TLSP1219 Stand Fits

CER7.....	200
GBG14.....	207
GBB15.....	207
HMRD12.....	264
MEL7.....	212
WSBM11.....	206
WSBL15.....	206
WSP15.....	206

#### TTRS3 Stand Fits

CER7.....	200
HMRD12.....	264
MEL7.....	212
WSBM11.....	206

**TTRS3** shown  
with three  
MEL7 bowls





**RISERS**

**ARB3 Risers Fit**

AWMSQ73	216
AWMSQ94	216
AWMSQ117	216
BAM73	247
BAM94	247
BAM124	247
CRGSQ73	208
CRGSQ94	208
CRGSQ117	208
FSMEL73	231
FSMEL94	231
FSMEL117	231
FSWME73	230
FSWME94	230
FSWME117	230
MELSQ73	210
MELSQ94	210
MELSQ117	210
MWMSQ7	233
MWMSQ9	233
MWMSQ11	233
SSQ73	267
SSQ94	267
SSQ117	267
SSQH73	267
SSQH94	267
SSQH117	267
TWBB73	243
TWBB94	243
TWBB117	243

**AWR10 Risers Fit**

AWMEL19	216
AWMEL21	216
AWMEL23	216
BAM14	246
BAM18	246
BAM22	246
CER19	199
CER21	199
CER23	199
CRGT19	208
CRGT21	208
CRGT23	208
FSMEL19	232
FSMEL21	232
FSMEL23	232
HMRT814	265
HMRT1019	265
HMRT1322	265
MEL19	215
MEL21	215
MEL23	215
MWMEL19	233
MWMEL21	233
MWMEL23	233
WMEL19	242
WMEL21	242
WMEL23	242

**BRT1 Riser Fits**

AB189	257
AB249	257
AB329	257
MW18	234
MW24	234
MW32	234
MWP18	251
MWP24	251
MWP32	251

**BRT2 Riser Fits**

AB189	257
AB249	257
AB329	257
MW18	234
MW24	234
MW32	234
MWP18	251
MWP24	251
MWP32	251

**BRT3 Riser Fits**

AB189	257
AB249	257
AB329	257
MW18	234
MW24	234
MW32	234
MWP18	251
MWP24	251
MWP32	251

**ARCH STAND**

**TASSM Stand Fits**

AWMSQ53	216
BAM53	247
CRGSQ53	208
FSMEL53	231
FSWME53	230
GJ24	65
MELSQ53	210
MSJ4	64
MWMSQ5	233
SQVY4	133
SSQ53	267
SSQH53	267
TWBB53	243
WCBA4	299
WCBL4	301
WCV4	131

**TASMED Stand Fits**

AWMSQ94	216
BAM94	247
CRGSQ94	208
FSMEL94	231
MELSQ94	210
MWMSQ9	233
SSQ94	267
SSQH94	267
TWBB94	243

**TASLG Stand Fits**

AWMEL19	216
AWMSQ73	216
BAM14	246
BAM73	247
BG159	207
CER19	199
CRGSQ73	208
CRGT19	208
FSLT08	231
FSLW08	230
FSMEL19	232
FSMEL73	231
FSWME53	230
HMRT814	265
MEL148	214
MEL19	215
MELSQ73	210
MWMEL19	233
MWMSQ7	233
RTWVY1	199
SSQ73	267
SSQH73	267
TWBB73	243
WMEL19	242



## MERCHANDISING RISERS

### BRR6 and BRR9 Fit

BR15 (1) .....	287
GJ40 (3) .....	65
MSJ5 (3) .....	64



BRR9 shown with  
BR15 riser and  
(3) GJ40 jars

BRR6 shown with  
BR15 riser and  
(3) GJ40 jars

## CONDIMENT RACKS

BR15 Fits	BR126 Fits	BR128 Fits	BTS2 Fits	BWC12 Fits
GJ40 (3) .....	GJ8 (8) .....	GJ24 (6) .....	GJ24 (6) .....	GJ24 (3) .....
MSJ5 (3) .....	MSJ3 (8) .....	MSJ4 (6) .....	MSJ4 (6) .....	MSJ4 (3) .....
		WCBA4 (6) .....	WCBA4 (6) .....	WCBA4 (3) .....
		WCBL4 (6) .....	WCBL4 (6) .....	WCBL4 (3) .....
		WCV4 (6) .....	WCV4 (6) .....	WCV4 (3) .....

## POLYCARBONATE DOMES

LFTD3 Fits	LFTD4 Fits	LFTD8 Fits	LFTD11 Fits	LFTD12 Fits	LFTD135 Fits
MWP4 .....	MWP5 .....	ATP10 .....	ATP12 .....	ATP14 .....	MWP14 .....
250	250	257	257	257	250
		LFTPW11 .....	LFTPW12 .....	LFTPW13 .....	
		223	223	223	
		LFTPBI1 .....	LFTPBI2 .....	LFTPBI3 .....	
		223	223	223	
		MWP9 .....	MWP12 .....	MWP13 .....	
		250	250	250	
			PSP12 .....		
			204		



## COVERED SOLUTIONS ROLL-TOP COVERS

RCR13 Fits	RCR21 Fits	RCRD14 Fits
MREC13 .....	MREC21 .....	MRDB14 .....
220	220	220
MRECB13 .....	MRECB21 .....	MTP14 .....
220	220	220
MW1210 .....	MW2012 .....	
297	297	

## CHAFFER FRAME ACCESSORIES

CFKIT Fits
CF1 .....
173
KBC20 .....
174
KSMC20 .....
174
SCF2 .....
173

## STORAGE CONTAINER

SCBL Fits
ADAGIORD18 .....
172
GOLDAGR18 .....
172
MACD3 .....
172
MESA91C .....
170
MESA91H .....
170
REVLRD20 .....
168
REVLRT26 .....
168





**BEVERAGE INSERTS**

IBT65 Fits	IBT126 Fits	IBT125 Fits	IBT200 Fits
BEVB556 ..... 303	BEVB6612 ..... 303	BEVDG129 ..... 302	BEV1220 ..... 303
BEVC655 ..... 303	BEVC1266 ..... 303	BEVG129 ..... 302	BEV820 ..... 303
BEVDG6 ..... 302	BEVDG126 ..... 302	BNRB129 ..... 301	BEVDG20 ..... 302
BEVG6 ..... 302	BEVG126 ..... 302	KBC10 ..... 174	BEVG20 ..... 302
BNRB6 ..... 301	BNRB126 ..... 301	KSMC10 ..... 174	BNRB20 ..... 301
KBC6 ..... 174	KBC12 ..... 174		KBC20 ..... 174
KSMC6 ..... 174	KSMC12 ..... 174		KSMC20 ..... 174
WTBA6 ..... 299	WTBA12 ..... 299		WTBA20 ..... 299
WTBL6 ..... 301	WTBL12 ..... 301		WTBL20 ..... 301
WTV6 ..... 300	WTV12 ..... 300		WTV20 ..... 300



**FLIGHT BOARDS**

BWF3 Fits	BWF4 Fits
GMB6 ..... 67	GMB6 ..... 67
GMB8 ..... 67	GMB8 ..... 67

**SHAKER CADDY ATTACHMENTS**

SCAR9 Fits	SCAT9 Fits
190039 ..... 432	RSR10 ..... 434
RSB312 ..... 434	RSRB ..... 434
RSRB7 ..... 434	SDRCK ..... 432

**COLD CELL**

COLD8 Fits
SBBL (2) ..... 177
SBBS ..... 177
WCVL (2) ..... 300
WCVS ..... 300







## CARE AND USE

### Melamine Dinnerware and Serveware

This nearly indestructible line of melamine is long-lasting when cared for properly. It is not recommended for microwave use and should be washed only in a high-temperature dishwasher. Not for use with a heat lamp or in the oven. Regarding serving suggestions, we do not recommend any citric, acidic or strong-colored food products that would have direct contact with melamine. These products can cause staining over time. PET liners that can protect melamine from staining are available for some items.



### Wrought Iron Griddles

Prior to using your American Metalcraft griddle for the first time, hand wash with a mild detergent and warm water. Then dry thoroughly with a soft cloth. Do not put wrought iron griddles in dishwashers or expose them to abrasive sponges, caustic cleaners or acidic detergents.

### Wood Peels and Serving Boards

Wood pizza peels and serving boards should never be soaked in water, even for a few minutes. To clean, simply wipe down with a damp cloth and allow to air dry. They can be seasoned or sealed with oil. To seal, wipe any food-safe oil such as mineral oil on the surface of the peel or board. If sealed properly, the peel or board is less likely to pick up unwanted odors, food particles and moisture. If a peel or board warps, leave overnight with the warp facing up and it should flatten out. Avoid leaving peels or boards on hot surfaces. This increases the chance of warping.



### Carbon and Black Steel Fry and Paella Pans

Seasoning is recommended. To season, wipe interior of pan with flavorless cooking oil and heat empty pan. When surface becomes hot, remove from heat and allow pan to cool. Repeat this process twice. Color of pan will change to a darker finish. This indicates that the pan has gained a natural non-stick protection.

To clean, hand wash in hot water with mild detergent. Dry with paper towel or place in warm oven for a few minutes. Re-season the pan when necessary to prevent food from sticking. Store in dry place. Do not put in dishwasher or expose to abrasive sponges or acidic detergents. Not suitable for microwave.

**CAUTION:** Handles are not heat-resistant.

### Galvanized Pails and Tubs

To clean, hand wash in warm water with mild detergent and dry quickly. Do not put in dishwasher or expose to abrasive sponges, bristles, caustic cleaners or acidic detergents. Do not refrigerate, soak in water or use with acidic foods.



### Hammered Copper

As beautiful as these lines are, they require special attention when cleaning. Please hand wash only with a soft cloth. Do not scour with steel wool or abrasive cleaners. Copper polish may be required to maintain the beauty of the surface.

### Securit Signs

To erase Securit Original Chalk Marker messages on Table Boards, Mini Chalkboards, Wall Boards, Sandwich Boards and other Securit signage, wipe with a soapy cloth followed by a clean cloth.



## Cast Iron

### Before First Use

Hand wash and dry immediately. Rub with a thin, light coat of vegetable oil to restore sheen.

### After First Use

Wash with hot water (and mild soap if necessary). Dry immediately and rub with a light coat of vegetable oil. To remove excess residue, use boiling water and a plastic scrub bun or brush. Dishwashing, acidic detergents and scouring pads/bristles are not recommended. Re-season the pan when necessary to prevent food from sticking.

### Daily Care Notes

Never put cold water in a hot cast iron pan; this can cause the pan to crack or warp. Store in a cool and dry place. Gas flames should not extend up the sides of cast iron cookware. When deep frying, fill cast iron cookware only to 1/3 of capacity.



## PIZZA PANS AND TRAYS

### Aluminum Pans and Trays

Aluminum is a soft metal that is attacked by detergents with a high alkaline or acidic nature. Use detergents made specifically for aluminum. Through repeated use, aluminum will soften and, if scoured, will thin. Hand wash only using mild detergent made specifically for aluminum. Do not put in the dishwasher.



### Tin Plate Pans

Tin plate should be seasoned before use and may need periodic re-seasoning. Tin plate will darken with use. Tin plate will also rust if refrigerated, soaked in water or left unseasoned in damp environments. Never soak in water or put in the dishwasher. Wipe dry immediately after hand washing.

### To Season Tin Plate Pans

Wash in warm, soapy water and quickly dry. Brush oil on inside and outside surfaces of the pan and bake to a golden or dark brown. When seasoning, bake at regular times and temperatures. Some pans may need a second or third coating before being fully seasoned.



### Hard Coat Pans

These pans are made from heavy-weight aluminum. Hard coat anodizing is a synergistic electro-chemical process that converts the surface of aluminum into aluminum oxide. The aluminum oxide is a dark color. The finish is hard and will not flake off. However, the aluminum underneath is soft and, through repeated use, the pan will soften. If scoured, the pan will thin. Hard coat pans are not non-stick and must be seasoned. Do not put these pans in dishwashers or expose them to caustic cleaning solutions. Hand wash only using mild detergent made specifically for aluminum.

### To Season Hard Coat Pans

Wash and dry pans thoroughly. Wipe oil on the inside and outside surfaces of the pan and allow it to soak in for 30 minutes. Then, bake at regular cooking times and temperatures. Do not overbake and do not wash off excess oil. Just wipe clean. The oil residue and any additional oil added before baking makes the pan stick-resistant.



### Pizza Stones

Pizza stones are freezer-, microwave- and oven-safe. They are not dishwasher-safe and require hand washing. Simply rinse in warm water before first use and allow the stone to dry thoroughly. It is recommended to preheat the stone 15-20 minutes for even cooking and to reduce baking time. To prevent cracking, avoid moving the stone between extreme temperatures such as from an oven to cold water. Allow the stone to cool completely before cleaning. To avoid a soapy aftertaste, do not use soap or detergents while cleaning. Simply remove baked-on foods and rinse in warm water. Do not soak or put in a dishwasher. Most stones will darken gradually and retain some staining with use. These are part of the stone's natural seasoning and will not affect the taste of the food. Handle each stone with care to prevent chipping or breaking.



## TERMS AND CONDITIONS (2024 Catalog Effective 1/1/24)

**COUNTRY OF ORIGIN**  indicate products made in the United States of America.

**LITERATURE** Possession of our literature does not constitute an offer to sell.

**PRINTING** We are not responsible for printing errors.

© American Metalcraft, Inc. 2024. All Rights Reserved





10SD.....	383	2600.....	307	7010.....	415	18912SPHC.....	404
19SET.....	160	2601H.....	307	7011.....	415	18913.....	415
106.....	359	2616.....	445	7012.....	415	18913P.....	404
130S0.....	381	2814.....	442	7013.....	415	18913PHC.....	404
131PE.....	381	3016.....	442	7014.....	415	18913SP.....	404
132SL.....	381	3209.....	442	7015.....	415	18913SPHC.....	404
240.....	453	3218.....	444	7016.....	415	18914.....	415
300.....	453	3300.....	149, 430	7017.....	415	18914P.....	404
360.....	453	3306.....	147, 428	7018.....	415	18914PHC.....	404
363.....	396	3306T.....	150, 428	9525.....	425	18914SP.....	404
420.....	453	3307.....	147, 428	13001.....	393	18914SPHC.....	404
450.....	308	3307T.....	150, 428	13005.....	393	18915.....	415
475.....	79, 395	3308.....	147, 428	17080.....	442	18915P.....	404
480.....	453	3309.....	147, 428	17135.....	442	18915PHC.....	404
510K.....	358	3312.....	149, 430	17160.....	442	18915SP.....	404
510P.....	358	3312T.....	150, 428	18040.....	402	18915SPHC.....	404
511K.....	358	3316.....	149, 430	18706.....	402	18916.....	415
511P.....	358	3316T.....	150, 428	18707.....	402	18916P.....	404
512K.....	358	3317.....	149, 430	18708.....	402	18916PHC.....	404
524.....	396	3317T.....	150, 428	18709.....	402	18916SP.....	404
524ST.....	376	3318.....	149, 430	18710.....	402	18916SPHC.....	404
674.....	443	3318T.....	150, 428	18711.....	402	18917.....	415
699.....	396	3319.....	149, 430	18712.....	402	18917P.....	404
699ST.....	376	3319T.....	150, 428	18713.....	402	18917PHC.....	404
744.....	395	3512.....	442	18714.....	402	18917SP.....	404
801.....	395	3612.....	444	18715.....	402	18917SPHC.....	404
814.....	445	3614.....	444	18716.....	402	18918.....	415
836.....	445	3616.....	444	18717.....	402	18918P.....	404
897.....	395	3714.....	442	18718.....	402	18918PHC.....	404
913.....	396	3801.....	394	18719.....	402	18918SP.....	404
913ST.....	376	3806.....	394	18720.....	402	18918SPHC.....	404
918.....	395	3807.....	394	18724.....	402	18919.....	415
918SS.....	79	3808.....	394	18728.....	402	18919P.....	404
989.....	395	3809.....	394	18731.....	402	18919PHC.....	404
998.....	395	3810.....	394	18744.....	402	18919SP.....	404
1004.....	396	3812.....	394	18907.....	415	18919SPHC.....	404
1139.....	445	3813.....	394	18907P.....	404	18920.....	415
1187.....	395	3814.....	394	18907PHC.....	404	18920P.....	404
1187SS.....	79	4016.....	442	18907SP.....	404	18920PHC.....	404
1188.....	79, 395	4100.....	308	18907SPHC.....	404	18920SP.....	404
1190.....	79, 395	4150.....	308	18908.....	415	18920SPHC.....	404
1200.....	79, 395	4212.....	444	18908P.....	404	19001.....	160
1300.....	79, 395	4214.....	444	18908PHC.....	404	19004.....	160
1300SS.....	79	4216.....	444	18908SP.....	404	19006.....	387, 436
1347.....	391	4218.....	444	18908SPHC.....	404	19007.....	387
1423.....	390	4220.....	444	18909.....	415	19008.....	386
1597.....	453	4406.....	146, 427	18909P.....	404	19009.....	439
1597H.....	453	4406T.....	146, 427	18909PHC.....	404	19024.....	440
1600.....	395	4407.....	146, 427	18909SP.....	404	19029.....	440
1636.....	445	4407T.....	146, 427	18909SPHC.....	404	19030.....	440
1698.....	453	4909.....	442	18910.....	415	19033.....	440
1836.....	445	5212.....	442	18910P.....	404	19075.....	387
1842.....	445	5414.....	442	18910PHC.....	404	19104.....	440
2109.....	442	5616.....	442	18910SP.....	404	19107.....	440
2124.....	453	6109.....	442	18910SPHC.....	404	28710.....	403
2130.....	453	6412.....	442	18911.....	415	28711.....	403
2136.....	453	6614.....	442	18911P.....	404	28712.....	403
2142.....	453	6816.....	442	18911PHC.....	404	28713.....	403
2148.....	453	7006.....	415	18911SP.....	404	28714.....	403
2154.....	453	7007.....	415, 422	18911SPHC.....	404	28715.....	403
2212.....	445	7007E.....	422	18912.....	415	28716.....	403
2242.....	445	7008.....	415, 422	18912P.....	404	28717.....	403
2414.....	445	7008E.....	422	18912PHC.....	404	28718.....	403
2512.....	442	7009.....	415	18912SP.....	404	159740.....	453

159760.....	453	A90152.....	410	AFAUC1.....	169, 171, 189	ATP16.....	257, 446
190039.....	432	A90161.5.....	410	AFP958.....	393	AWB7.....	248
1900312.....	432	A90162.....	410	AHM485.....	390	AWB10.....	248
A2006.....	408	A90671.5.....	410	ALLEGCU1.....	189	AWB12.....	248
A2007.....	408	A90672.....	410	ALLEGCU2.....	189	AWB147.....	248
A2008.....	408	AB6.....	269	ALMH4.....	313	AWB179.....	249
A2009.....	408	AB8.....	269	ALMS5.....	313	AWB617.....	249
A2010.....	408	AB10WH.....	39	A0080.....	161	AWB621.....	249
A2011.....	408	AB12.....	269	A0120.....	161	AWB1016.....	249
A2012.....	408	AB12WH.....	39	A0150.....	161	AWB1021.....	249
A2013.....	408	AB13.....	269	AOR18.....	397	AWB1210.....	248
A2014.....	408	AB14.....	269	AOR24.....	397	AWC49.....	362
A2015.....	408	AB16WH.....	39	AOR36.....	397	AWM10.....	240
A2016.....	408	AB30WH.....	39	AOR48.....	397	AWM12.....	240
A2017.....	408	AB131.....	173	API2WH.....	39	AWM14.....	240
A2018.....	408	AB189.....	257, 285	APC2.....	437	AWM17.....	240
A4004.....	412	AB211.....	173	APCU.....	163	AWM21.....	240
A4006.....	412	AB249.....	257, 285	AR060.....	161	AWM25.....	240
A4007.....	412	AB329.....	257, 285	AR080.....	161	AWM171.....	240
A4008.....	412	ABHB46.....	81	AR100.....	161	AWMB11.....	241
A4009.....	412	ABHB69.....	81	ARB3.....	287	AWMB12.....	241
A4010.....	412	ABHC46.....	81	ARP6WH.....	39	AWMB14.....	241
A4011.....	412	ABHC69.....	81	ARP7WH.....	39	AWMEL19.....	216
A4012.....	412	ABHG46.....	81	ARP9WH.....	39	AWMEL21.....	216
A4013.....	412	ABHG69.....	81	ARPI0WH.....	39	AWMEL23.....	216
A4014.....	412	ABHS46.....	81	AS20.....	280	AWMSQ53.....	216
A4015.....	412	ABHS69.....	81	ASC5.....	384	AWMSQ73.....	216
A4016.....	412	AC555.....	296	ASC12.....	384	AWMSQ94.....	216
A9005.....	410	AC579.....	293	ASC24.....	384	AWMSQ117.....	216
A9006.....	410	AC777.....	296	ASC38.....	384	AWR10.....	295
A80012.....	394	ACB118.....	313	ASC58.....	384	AWRRP.....	295
A80061.5.....	413	ACC.....	338	ASC84.....	384	AWRS.....	295
A80062.....	413	ACCH.....	338	ASEAB12.....	272	AWRSP.....	295
A80071.5.....	413	ACF125.....	313	ASEAB14.....	272	B10.....	47
A80072.....	413	ACH1.....	313	ASEAC12.....	272	B10G.....	47
A80081.5.....	413	ACM.....	338	ASEAC14.....	272	B10W.....	47
A80082.....	413	ACMH.....	338	ASEAG12.....	272	B11G.....	46
A80091.5.....	413	ACS.....	350	ASEAG14.....	272	B11W.....	46
A80092.....	413	ACSH.....	350	ASEAS12.....	272	B12.....	247
A80101.5.....	413	ACT.....	338	ASEAS14.....	272	B12G.....	47
A80102.....	413	ACTH.....	338	ASPB.....	81, 124	B12W.....	47
A80112.....	413	ADAGIORD18.....	172	ASPC.....	81, 124	B14.....	247
A80121.5.....	413	ADAGIORT26.....	172	ASPG.....	81, 124	B14G.....	46
A80122.....	413	ADEP6.....	409	ASPS.....	81, 124	B14W.....	46
A80132.....	413	ADEP7.....	409	ATCU.....	163	B16.....	247
A80142.....	413	ADEP8.....	409	ATHB9.....	305, 367	B31.....	136
A80162.....	413	ADEP9.....	409	ATHB10.....	305, 367	B34.....	136
A90071.5.....	410	ADEP10.....	409	ATHB14.....	305, 367	B102W.....	47
A90072.....	410	ADEP11.....	409	ATHB16.....	305, 367	B104W.....	47
A90081.5.....	410	ADEP12.....	409	ATHC9.....	305, 367	B112W.....	46
A90082.....	410	ADEP13.....	409	ATHC10.....	305, 367	B114W.....	46
A90091.5.....	410	ADEP14.....	409	ATHC14.....	305, 367	B122W.....	47
A90092.....	410	ADEP15.....	409	ATHC16.....	305, 367	B124W.....	47
A90101.5.....	410	ADEP16.....	409	ATHG9.....	305, 367	B144W.....	46
A90102.....	410	ADEP17.....	409	ATHG10.....	305, 367	BA640A.....	398
A90111.5.....	410	ADEP18.....	409	ATHG14.....	305, 367	BA640S.....	398
A90112.....	410	ADSEAB12.....	272	ATHG16.....	305, 367	BA740A.....	398
A90121.5.....	410	ADSEAB14.....	272	ATHS9.....	305, 367	BA740S.....	398
A90122.....	410	ADSEAC12.....	272	ATHS10.....	305, 367	BA840A.....	398
A90131.5.....	410	ADSEAC14.....	272	ATHS14.....	305, 367	BA840S.....	398
A90132.....	410	ADSEAG12.....	272	ATHS16.....	305, 367	BA940A.....	398
A90141.5.....	410	ADSEAG14.....	272	ATP10.....	257, 446	BA940S.....	398
A90142.....	410	ADSEAS12.....	272	ATP12.....	257, 446	BA1040A.....	398
A90151.5.....	410	ADSEAS14.....	272	ATP14.....	257, 446	BA1040S.....	398



BAKNOB.....	398	BCR9ST.....	332	BLB1926.....	450	BPF8.....	333
BAM14.....	246	BCRI5ST.....	332	BLBAG19.....	450	BPG67.....	113
BAM18.....	246	BD35.....	56	BLBAG26.....	450	BPG101.....	113
BAM22.....	246	BD45.....	56	BLCHBC1.....	314	BPH21.....	333
BAM53.....	247	BD55.....	56	BLCHD1.....	314	BPNS115.....	152
BAM73.....	247	BD65.....	56	BLCHL1.....	314	BPR42CO.....	43
BAM94.....	247	BD72.....	56	BLCHL2.....	314	BPR84BI.....	43
BAM124.....	247	BD87.....	56	BLCHR1.....	314	BPR128CR.....	43
BAM141.....	246	BD93.....	56	BLCHS1.....	314	BPS4CO.....	43
BAM148.....	246	BDS2.....	319	BLDB1212.....	451	BPS8CR.....	43
BAM189.....	246	BDS3.....	319	BLDB2216.....	451	BPSW15.....	333
BAM211.....	246	BDS4.....	319	BLDB2412.....	451	BPSW20.....	333
BAM1812.....	246	BEE300.....	148, 429	BLDX1805.....	450	BPT3.....	124
BAMBL4.....	317	BEE312.....	148, 429	BLDX2005.....	450	BPW13.....	333
BAMBL125.....	317	BEE316.....	148, 429	BLH19.....	334	BPWC7.....	333
BAMCH4.....	317	BEE317.....	148, 429	BLHF10.....	190	BR15.....	286, 287
BAMCH125.....	317	BEE318.....	148, 429	BLHML.....	190	BR126.....	287
BAMRD2.....	298	BEE319.....	148, 429	BLHP10.....	190	BR128.....	287
BAMRN1.....	298	BEE600.....	148, 429	BLHSA10.....	190	BROWNBM1218.....	375
BAMRSET.....	298	BEE606.....	148, 429	BLHSP.....	190	BRR6.....	286
BAMSL52.....	247	BEE607.....	148, 429	BLHSP6.....	190	BRR9.....	286
BAMSL82.....	247	BEV820.....	303	BLHSP10.....	190	BRS2.....	293
BAMSL92.....	247	BEV1220.....	303	BLHSS.....	190	BRT1.....	284
BAMSL112.....	247	BEVB556.....	303	BLHSS10.....	190	BRT2.....	284
BAR6.....	373	BEVB6612.....	303	BLHT1.....	190	BRT3.....	284
BARB5.....	128, 372	BEVC655.....	303	BLHT2.....	190	BS18.....	350
BARB7.....	128, 372	BEVC1266.....	303	BLHT6.....	190	BS28.....	350
BARC5.....	128, 372	BEVDG6.....	302	BLLB81.....	96	BS31.....	136
BARC7.....	128, 372	BEVDG20.....	302	BLLB94.....	96	BS64.....	385
BARG5.....	128, 372	BEVDG126.....	302	BLM24.....	375	BSB12.....	357
BARG7.....	128, 372	BEVDG129.....	302	BLR14.....	334	BSFP8.....	378
BARS5.....	128	BEVG6.....	302	BLS14.....	334	BSFP10.....	378
BARS7.....	373	BEVG20.....	302	BLSB80.....	96	BSFP11.....	378
BAS1.....	103	BEVG126.....	302	BLSB93.....	96	BSFP12.....	378
BASQ620.....	398	BEVG129.....	302	BLSB1512.....	451	BSG12.....	357
BASQ820.....	398	BG159.....	207	BLSMA100V4CO.....	321	BSH20.....	335
BASQ1020.....	398	BG189.....	207	BLSMA100V4TR.....	321	BSKB80.....	98
BB1WH.....	48	BG1911.....	207	BLSMA100V4WH.....	321	BSKB96.....	98
BB2.....	345	BG2113.....	207	BLSMA510WT.....	321	BSKB811.....	99
BB4.....	322	BH31.....	136	BLUP5.....	45	BSKC08.....	98
BB5WH.....	48	BHCHBC1.....	314	BLUP6.....	45	BSKC69.....	98
BB8.....	322	BHCHD1.....	314	BLUP8.....	45	BSKC118.....	99
BB12.....	322	BHCHL1.....	314	BLUP11.....	45	BSPH2.....	124
BB15.....	322	BHCHL2.....	314	BLUP14.....	45	BSPH4.....	124
BB812.....	259	BHCHR1.....	314	BM16H.....	337	BSPP4.....	56
BB816.....	259	BHCHS1.....	314	BM16P.....	337	BSPP5.....	56
BB6105.....	359	BHH19.....	334	BM23.....	375	BSPP6.....	56
BBC2.....	345	BHM2.....	148	BMH221.....	308	BSPP8.....	56
BBC39.....	374	BHMPLUGS.....	154	BNCB84.....	128	BSPP9.....	56
BBLWH.....	48	BHR14.....	334	BNCC48.....	128	BSPP11.....	56
BBLWM.....	48	BHS109.....	350	BNRB6.....	301	BSPP12.....	56
BBR4CO.....	43	BHS117.....	350	BNRB20.....	301	BSPT5.....	124
BBR12.....	322	BHS124.....	350	BNRB46C.....	97	BSR14.....	335
BBR15.....	322	BHSP2.....	154	BNRB64B.....	97	BSS7.....	102
BBR20BI.....	43	BL10G.....	47	BNRB68C.....	97	BSS8.....	102
BBRB.....	322	BL10W.....	47	BNRB86B.....	97	BSS11.....	102
BBRC.....	345	BL11G.....	46	BNRB126.....	301	BSS12.....	357
BBS9CO.....	43	BL11W.....	46	BNRB129.....	301	BSSET.....	350
BBS44CR.....	43	BL12G.....	47	BNSB3.....	126	BSST12.....	357
BC1.....	314	BL12W.....	47	BNSC3.....	126	BT12X12.....	375
BCH4.....	315	BL14G.....	46	BP39.....	439	BTS2.....	287
BCH18ST.....	332	BL14W.....	46	BP51.....	439	BTS12.....	365
BCH125.....	315	BLACKBM1218.....	375	BPCL72.....	333	BTS16.....	365
BCM2.....	124	BLB1914.....	450	BPD13.....	333	BTTL9.....	361

B TTL11.....	361	CAR10.....	405	CBL40CL.....	23	CHC2.....	120
B TTL13.....	375	CAR10HC.....	405	CBL40SH.....	23	CHC4.....	120
BUH18.....	335	CAR11.....	405	CBL50CL.....	23	CHG2.....	120
BUR15.....	335	CAR11HC.....	405	CBL50SH.....	23	CHG4.....	120
BUS309.....	432	CAR12.....	405	CBL54ST.....	213, 392	CHGS.....	316
BUS312.....	432	CAR12HC.....	405	CBL78.....	213	CHPC.....	316
BVHF.....	190	CAR13.....	405	CBL95CL.....	22	CHPF.....	316
BVHF10.....	190	CAR13HC.....	405	CBL95SH.....	22	CHPH.....	316
BVHL.....	190	CAR14.....	405	CBL96SH.....	213, 392	CHPP.....	316
BVHML.....	190	CAR14HC.....	405	CBL141CL.....	213, 392	CHS2.....	120
BVHP10.....	190	CAR15.....	405	CBL185.....	213	CHS4.....	120
BVHSA10.....	190	CAR15HC.....	405	CBL325.....	213	CHSP2.....	154
BVHSP.....	190	CAR16.....	405	CBP16CL.....	22	CIFD.....	59
BVHSP6.....	190	CAR16HC.....	405	CBP16SH.....	22	CIFDR.....	59
BVHSP10.....	190	CAR17.....	405	CBR15.....	322	CIG85.....	58, 183
BVHSS.....	190	CAR17HC.....	405	CBRB.....	322	CIP03.....	182
BVHSS10.....	190	CAR18.....	405	CBRB12.....	322	CIP04.....	182
BVHT1.....	190	CAR18HC.....	405	CBS33.....	365	CIP0V63.....	58, 183
BVHT2.....	190	CAR19.....	405	CC10C.....	383	CIP0V856.....	58, 183
BVHT6.....	190	CAR19HC.....	405	CC10F.....	383	CIP0V6040.....	58, 183
BVJGB5.....	145	CAR20.....	405	CC12C.....	383	CIP0V9567.....	58, 183
BVJGG4.....	145	CAR20HC.....	405	CC12F.....	383	CIPR3.....	182
BVJM8.....	145	CAR21.....	405	CCAW7.....	104	CIPR4.....	182
BVTB7.....	145	CAR21HC.....	405	CCAW8.....	104	CIPR42.....	58, 183
BVTG6.....	145	CAR95.....	405	CCAW9.....	104	CIPR5125.....	58, 183
BVTM9.....	145	CAR95HC.....	405	CCPLUGS.....	153	CIPR5500.....	58, 183
BWB105.....	244	CB4.....	322	CD4.....	371	CIPR5526.....	58, 183
BWB109.....	244	CB8.....	322	CD5.....	371	CIPR6250.....	58, 183
BWB185.....	244	CB12.....	322	CD6.....	371	CIPR7251.....	58, 183
BWB189.....	244	CB15.....	322	CDB4.....	371	CIPRT5336.....	58, 183
BWB750.....	103	CB338.....	396	CDB5.....	371	CIPS61.....	58, 183
BWBL.....	245	CBC7CL.....	23	CDB6.....	371	CIS8.....	182
BWB0.....	245	CBC7SH.....	23	CDCV77.....	173	CIS10.....	182
BWBR.....	245	CBC7ST.....	25	CDFP33.....	170	CIS12.....	182
BWBS.....	245	CBC8.....	389	CDFP44.....	170	CIS14.....	182
BWC9.....	109	CBC9.....	389	CDFP55.....	173	CIS41.....	58, 183
BWC12.....	109	CBC10.....	389	CDFP88.....	168, 172	CIS51.....	58, 183
BWF3.....	244, 343	CBC10CL.....	23	CDWP18.....	172	CIS61.....	58, 183
BWF4.....	244, 343	CBC10SH.....	23	CDWP26.....	172	CKNF1.....	197
BWP84.....	114	CBC10ST.....	25	CDWP66.....	173	CKNF2.....	197
BWPG84.....	114	CBC12.....	389	CDWPM19.....	170	CKNF3.....	197
BWPH84.....	114	CBF8.....	389	CDWPM27.....	170	CKNF4.....	197
BWPHG84.....	114	CBF9.....	389	CER5.....	200	CKNF5.....	197
BWR34.....	161	CBF10.....	389	CER7.....	200	CKNF6.....	197
BZZ59C.....	95	CBF12.....	389	CER9.....	200	CKNF7.....	197
BZZ95B.....	95	CBL4CL.....	23	CER15.....	199	CKNF8.....	197
CADDYSS.....	151	CBL4SH.....	23	CER19.....	199	CKOW1.....	197
CADDYSS2.....	119	CBL8CL.....	22	CER21.....	199	CKOW2.....	197
CADDYW.....	151	CBL8SH.....	22	CER23.....	199	CKOW3.....	197
CADDYW2.....	119	CBL12CL.....	23	CER25.....	199	CKOW4.....	197
CAP2.....	146, 427	CBL12SH.....	23	CERAM12.....	419	CKOW7.....	197
CAP3.....	67	CBL12ST.....	25	CERAM14.....	419	CKOW8.....	197
CAP6.....	67	CBL13CL.....	22	CERAM16.....	419	CLIPIT2.....	313
CAP8.....	67	CBL13SH.....	22	CERAM18.....	419	CLIPIT6.....	313
CAP16.....	67	CBL16CL.....	23	CF1.....	173	CM4.....	144
CAP25.....	146, 427	CBL16SH.....	23	CFKIT.....	173	CM12CL.....	23
CAR6.....	405	CBL16ST.....	25	CFP4.....	132	CM12SH.....	23
CAR6HC.....	405	CBL20CL.....	22	CH4.....	308	CM12ST.....	25
CAR7.....	405	CBL20SH.....	22	CH6.....	308	CM16H.....	337
CAR7HC.....	405	CBL20ST.....	25	CH8.....	308	CM16P.....	337
CAR8.....	405	CBL24CL.....	23	CH10.....	308	CM96H.....	336
CAR8HC.....	405	CBL24SH.....	23	CHB32.....	365	CM192H.....	336
CAR9.....	405	CBL32CL.....	23	CHBS.....	316	CMCC5.....	118
CAR9HC.....	405	CBL32SH.....	23	CHBST112.....	374	CMCSW2.....	318



CMP425.....	318	CSJCUP.....	351	DPN9DN.....	35	DWPS64.....	115
CMP520.....	318	CSM2.....	105, 431	DPN9LN.....	35	DWRB2.....	177, 279
CMP553.....	318	CSM3.....	105, 431	DPN9WH.....	32	DWRB5.....	177, 279
CMSP.....	153	CSM40.....	105, 431	DPNIODN.....	35	DWS2.....	138
COLD8.....	177	CSP2.....	154	DPNIOLN.....	35	DWS5.....	117
CP6CL.....	22	CSP4.....	203	DPNIOWH.....	32	DWSC7.....	135
CP6SH.....	22	CSPR1.....	153	DPR1.....	348	DWSEA10.....	270
CP6ST.....	25	CSPS3.....	153	DPS797.....	435	DWSEA12.....	270
CP7CL.....	22	CSPT2.....	153	DPW6WH.....	32	DWSEA14.....	270
CP7SH.....	22	CSR26.....	168	DPW7WH.....	32	DWSEA16.....	270
CP7ST.....	25	CT2.....	146, 427	DPW9WH.....	32	DWSEA18.....	270
CP9CL.....	22	CTP6.....	407	DPWIOWH.....	32	DWSS5.....	138
CP9SH.....	22	CTP7.....	407	DRB18230.....	422	DWWC5.....	361
CP9ST.....	25	CTP8.....	407	DRBC1826.....	422	DWWP50.....	117
CP10CL.....	22	CTP9.....	407	DRP774.....	422	DXCH1.....	315
CP10SH.....	22	CTP10.....	407	DRP884.....	422	DXP4.....	155
CP10ST.....	25	CTP11.....	407	DRPE800.....	422	EBB59B.....	95
CP12CL.....	22	CTP12.....	407	DRPE878.....	422	EBB95C.....	95
CP12SH.....	22	CTP13.....	407	DRPS5725.....	422	EBSS312.....	374
CP12ST.....	25	CTP14.....	407	DRPS5825.....	422	ELEBLA.....	320
CP150.....	145	CTP15.....	407	DS5WH.....	32	ELEBME.....	320
CP300.....	145	CTP16.....	407	DS6704.....	385, 423	ELEBSM.....	320
CP500.....	145	CTP17.....	407	DS6706.....	385, 423	EM199.....	308, 426
CPL12CL.....	22	CTP18.....	407	DSCIWH.....	33, 141	EM200.....	308, 426
CPL12SH.....	22	CTP19.....	407	DSC3WH.....	33, 141	EM400.....	308, 426
CPL14.....	213	CTS31.....	162	DSP11.....	417	EM1200.....	308, 426
CPL21.....	213	CWP7.....	390	DSP15.....	417	ER333.....	391
CPM62.....	152	CWP8.....	390	DSP18.....	417	ER387.....	391
CRGSQ53.....	208	CWP12.....	390	DSP6705.....	385, 423	ER444.....	391
CRGSQ73.....	208	D404.....	136	DT2.....	146, 427	ER487.....	391
CRGSQ94.....	208	D405.....	136	DT3.....	169, 189	ER587.....	391
CRGSQ117.....	208	D406.....	136	DT4.....	169, 189	ES474.....	391
CRGT19.....	208	DB5WH.....	33	DT6.....	146, 427	EWB6.....	78
CRGT21.....	208	DB7WH.....	33	DWB6.....	269	EWB8.....	78
CRGT23.....	208	DB8WH.....	33	DWB10.....	269	EWB10.....	78
CRH3.....	288	DB10DN.....	35	DWB12.....	269	EWM6.....	78
CRL86.....	106	DB10LN.....	35	DWB14.....	269	EWM16.....	78
CRM922.....	380	DB10WH.....	33	DWB16.....	269	FBC92.....	86
CRMK2.....	134	DB12WH.....	33	DWBH4.....	268, 362	FBS591.....	86
CRMK4.....	134	DBN16DN.....	35	DWBH6.....	268	FBSR43.....	89
CRMK6.....	134	DBN16LN.....	35	DWBH10.....	268	FBSS44.....	89
CRS1.....	293	DBN16WH.....	33	DWBH12.....	268	FCD1.....	86
CRS3.....	288	DBN24WH.....	33	DWBH14.....	268	FCD2.....	86
CRS68.....	106	DBN32WH.....	33	DWBH16.....	268	FCH35.....	69
CS8.....	359	DBP1826.....	422	DWBT15.....	369	FCH325.....	69
CS31.....	365	DBW16WH.....	33	DWBT185.....	369	FCS16.....	371
CS080.....	351	DD5274.....	424	DWC5.....	117	FFB59.....	86
CS100.....	351	DD5275.....	425	DWC7.....	339	FFC335.....	69
CS125.....	161	DD5701.....	424	DWCH7.....	339	FFC337.....	68
CS200.....	351	DD5703.....	425	DWCP16.....	117	FFCCH37.....	71
CS301.....	360	DD5704.....	425	DWCP48.....	116	FFCCH45.....	71
CS7545.....	360	DD5705.....	424	DWCP50.....	117	FFCCS45.....	71
CSC4CL.....	23, 141	DDCH7744.....	424	DWHSEA10.....	270	FFCCS337.....	71
CSC4SH.....	23, 141	DDCH7755.....	424	DWHSEA12.....	270	FFCG45.....	70
CSC4ST.....	25, 141	DDW5703.....	425	DWHSEA14.....	270	FFCG337.....	70
CSC15.....	134, 201	DDW5705.....	424	DWHSEA16.....	270	FFCGH37.....	70
CSC20.....	134, 201	DGSP35.....	125	DWHSEA18.....	270	FFCGH45.....	70
CSFP8.....	378	DM10WH.....	32	DWHVSEA14.....	276	FFCM2.....	68
CSFP10.....	378	DPL9WH.....	32	DWHVSEA18.....	276	FFCP4.....	74
CSFP11.....	378	DPL12DN.....	35	DWIB40.....	370	FFCP6.....	74
CSFP12.....	378	DPL12LN.....	35	DWP44.....	115	FFCS45.....	68
CSJ108.....	351	DPL12WH.....	32	DWP64.....	115	FFHANDLE.....	384
CSJ116.....	351	DPN6WH.....	32	DWPH64.....	114	FFHM2.....	68
CSJ174.....	351	DPN7WH.....	32	DWPS44.....	115	FFHM35.....	69

FFHM37.....	68	GB16.....	144	GGSW6.....	227	GSOVL.....	179
FFHM45.....	68	GB300.....	144	GGW74.....	227	GSP35.....	125
FFSD3.....	384	GB500.....	144	GGW76.....	227	GSPC.....	151
FFSR1.....	384	GB1000.....	144	GGW96.....	227	GSPH2.....	124
FGRS7.....	180	GB1600.....	144	GHSP2.....	154	GSPH4.....	124
FGRS10.....	180	GBB15.....	207	GHW4.....	362	GSPR.....	151
FH1.....	173	GBB20.....	207	GJ6.....	65	GSPS.....	151
FLRB8.....	212	GBE2.....	346	GJ8.....	65, 342	GSPSR.....	151
FLRB11.....	212	GBE3.....	346	GJ24.....	65	GSPT5.....	124
FLRB95.....	212	GBE8.....	346	GJ40.....	65, 286	GSREC.....	179
FRUB9.....	97	GBE17.....	346	GLA300.....	149, 430	GSS6.....	146, 427
FRUB12.....	102	GBE34.....	346	GLA312.....	149, 430	GSSI7.....	181
FRUB18.....	97	GBE64.....	346	GLA316.....	149, 430	GSSS20.....	178-180
FRUC7.....	97	GBG14.....	207	GLA317.....	149, 430	GSSS1526.....	180
FRUC10.....	102	GBG19.....	207	GLA318.....	149, 430	GSST17.....	180
FRUC16.....	97	GBS18.....	350	GLA319.....	149, 430	GSST2514.....	178, 180
FRYB433.....	88	GBS28.....	350	GLA600.....	146, 427	GTP10.....	78, 418
FRYB443.....	88	GBSSET.....	350	GLACT2.....	146, 427	GTP12.....	78, 418
FRYR375.....	88	GC4.....	119	GLADT2.....	146, 427	GTP14.....	78, 418
FRYS443.....	88	GC8.....	110, 347	GLADT6.....	146, 427	GTP16.....	78, 418
FRYT433.....	88	GC12.....	110, 347	GLAST2.....	146, 427	GTP18.....	78, 418
FS9.....	417	GC34.....	110, 347	GLBASE.....	146, 427	GVHF.....	191
FS911.....	388	GC36.....	110, 347	GM13.....	236	GVHF10.....	191
FSLT08.....	231	GCD28.....	110, 347	GM16H.....	337	GVHL.....	191
FSLT10.....	231	GCH28.....	110, 347	GM16P.....	337	GVHML.....	191
FSLT14.....	231	GCHB2.....	311	GM95.....	236	GVHP10.....	191
FSLT18.....	231	GCHB3.....	311	GM147.....	236	GVHSA10.....	191
FSLT21.....	231	GCHB4.....	311	GM189.....	236	GVHSP.....	191
FSLW08.....	230	GCHG2.....	311	GM210.....	236	GVHSP6.....	191
FSLW10.....	230	GCHG3.....	311	GM1614.....	236	GVHSP10.....	191
FSLW14.....	230	GCHG4.....	311	GM2113.....	236	GVHSS.....	191
FSLW18.....	230	GCHS2.....	311	GMB3.....	67	GVHSS10.....	191
FSLW21.....	230	GCHS3.....	311	GMB6.....	67	GVHT1.....	191
FSMEL12.....	232	GCHS4.....	311	GMB8.....	67, 342	GVHT2.....	191
FSMEL19.....	232	GCM2.....	124	GMB16.....	67, 342	GVHT6.....	191
FSMEL21.....	232	GCRB2613.....	91	GMB32.....	67	GW4.....	362
FSMEL23.....	232	GCRC1362.....	91	GOLDAGR18.....	172	GZB22.....	67
FSMEL53.....	231	GCS37.....	396	GOLDAGR26.....	172	HA2006.....	408
FSMEL73.....	231	GCSS6132.....	91	GOVB69.....	94	HA2007.....	408
FSMEL94.....	231	GDWC7.....	363	GOVB811.....	94	HA2008.....	408
FSMEL117.....	231	GDWW5.....	363	GOVS69.....	94	HA2009.....	408
FSR9.....	232	GF2.....	346	GOVS811.....	94	HA2010.....	408
FSR11.....	232	GF3.....	346	GP2.....	74	HA2011.....	408
FSR14.....	232	GF8.....	346	GP3.....	74	HA2012.....	408
FSWMEL53.....	230	GF17.....	346	GP4.....	74	HA2013.....	408
FSWMEL73.....	230	GF34.....	346	GP21.....	179	HA2014.....	408
FSWMEL94.....	230	GF68.....	346	GPT3.....	124	HA2015.....	408
FSWMEL117.....	230	GFC45.....	74	GPTUB20.....	80, 369	HA2016.....	408
FT15.....	135	GFC335.....	74	GR2.....	151	HA2017.....	408
FT25.....	135	GFC337.....	74	GRI435.....	376	HA2018.....	408
FT40.....	135	GGB74.....	227	GS4.....	119	HA4006.....	412
FWB4.....	86	GGB76.....	227	GS16.....	181	HA4007.....	412
FWC68.....	107	GGB96.....	227	GS18.....	181	HA4008.....	412
FWC69.....	107	GGRB3.....	226	GS27.....	181	HA4009.....	412
FWC89.....	107	GGRB5.....	226	GS81.....	181	HA4010.....	412
G17.....	178	GGRB6.....	226	GS1775.....	181	HA4011.....	412
G21.....	179	GGRB8.....	226	GSB2.....	110, 347	HA4012.....	412
G23.....	179	GGRW3.....	226	GSC2.....	110, 347	HA4013.....	412
G30.....	178	GGRW5.....	226	GSC6.....	146, 427	HA4014.....	412
G61.....	181	GGRW6.....	226	GSC16.....	175	HA4015.....	412
G72.....	181	GGRW8.....	226	GSC17.....	175	HA4016.....	412
G9595.....	425	GGSB5.....	227	GSC26.....	175	HA4017.....	412
GB3.....	144	GGSB6.....	227	GSD6.....	146, 427	HA4018.....	412
GB8.....	144	GGSW5.....	227	GSF2.....	110, 347	HA4019.....	412



HA4020.....	412	HA90162.....	411	HATP17.....	406	HC5116.....	414
HA5006.....	414	HA90171.5.....	411	HATP18.....	406	HC9005.....	411
HA5007.....	414	HA90172.....	411	HATP19.....	406	HC9006.....	411
HA5008.....	414	HA90181.5.....	411	HATP20.....	406	HC28710.....	403
HA5009.....	414	HA90182.....	411	HATP21.....	406	HC28711.....	403
HA5010.....	414	HA90671.5.....	411	HATP22.....	406	HC28712.....	403
HA5011.....	414	HA90672.....	411	HATP23.....	406	HC28713.....	403
HA5012.....	414	HACTP6.....	407	HATP24.....	406	HC28714.....	403
HA5013.....	414	HACTP7.....	407	HATP26.....	406	HC28715.....	403
HA5014.....	414	HACTP8.....	407	HATP28.....	406	HC28716.....	403
HA5015.....	414	HACTP9.....	407	HB5.....	82, 261	HC28717.....	403
HA5016.....	414	HACTP10.....	407	HB6.....	82, 261	HC28718.....	403
HA5017.....	414	HACTP11.....	407	HB7.....	82, 261	HC80061.5.....	413
HA5018.....	414	HACTP12.....	407	HC2006.....	408	HC80062.....	413
HA5106.....	414	HACTP13.....	407	HC2007.....	408	HC80071.5.....	413
HA5107.....	414	HACTP14.....	407	HC2008.....	408	HC80072.....	413
HA5108.....	414	HACTP15.....	407	HC2009.....	408	HC80081.5.....	413
HA5109.....	414	HACTP16.....	407	HC2010.....	408	HC80082.....	413
HA5110.....	414	HACTP17.....	407	HC2011.....	408	HC80091.5.....	413
HA5111.....	414	HACTP18.....	407	HC2012.....	408	HC80092.....	413
HA5112.....	414	HACTP19.....	407	HC2013.....	408	HC80101.5.....	413
HA5113.....	414	HACTP20.....	407	HC2014.....	408	HC80102.....	413
HA5114.....	414	HACTP21.....	407	HC2015.....	408	HC80112.....	413
HA5115.....	414	HACTP22.....	407	HC2016.....	408	HC80121.5.....	413
HA5116.....	414	HACTP23.....	407	HC2017.....	408	HC80122.....	413
HA9005.....	411	HACTP24.....	407	HC2018.....	408	HC80132.....	413
HA9006.....	411	HACTP26.....	407	HC4006.....	412	HC80142.....	413
HA80012.....	394	HACTP28.....	407	HC4007.....	412	HC80162.....	413
HA80061.5.....	413	HADEP6.....	409	HC4008.....	412	HC80182.....	413
HA80062.....	413	HADEP7.....	409	HC4009.....	412	HC90071.5.....	411
HA80071.5.....	413	HADEP8.....	409	HC4010.....	412	HC90072.....	411
HA80072.....	413	HADEP9.....	409	HC4011.....	412	HC90081.5.....	411
HA80081.5.....	413	HADEP10.....	409	HC4012.....	412	HC90082.....	411
HA80082.....	413	HADEP11.....	409	HC4013.....	412	HC90091.5.....	411
HA80091.5.....	413	HADEP12.....	409	HC4014.....	412	HC90092.....	411
HA80092.....	413	HADEP13.....	409	HC4015.....	412	HC90101.5.....	411
HA80101.5.....	413	HADEP14.....	409	HC4016.....	412	HC90102.....	411
HA80102.....	413	HADEP15.....	409	HC4017.....	412	HC90111.5.....	411
HA80112.....	413	HADEP16.....	409	HC4018.....	412	HC90112.....	411
HA80121.5.....	413	HADEP17.....	409	HC4019.....	412	HC90121.5.....	411
HA80122.....	413	HADEP18.....	409	HC4020.....	412	HC90122.....	411
HA80132.....	413	HADEP19.....	409	HC5006.....	414	HC90131.5.....	411
HA80142.....	413	HAMSC.....	137	HC5007.....	414	HC90132.....	411
HA80162.....	413	HAMSC3.....	137	HC5008.....	414	HC90141.5.....	411
HA80182.....	413	HAMSC4.....	137	HC5009.....	414	HC90142.....	411
HA90071.5.....	411	HAMSC15.....	137	HC5010.....	414	HC90151.5.....	411
HA90072.....	411	HAMSC25.....	137	HC5011.....	414	HC90152.....	411
HA90081.5.....	411	HAMSCB.....	137	HC5012.....	414	HC90161.5.....	411
HA90082.....	411	HAMSCB3.....	137	HC5013.....	414	HC90162.....	411
HA90091.5.....	411	HAMSCB4.....	137	HC5014.....	414	HC90171.5.....	411
HA90092.....	411	HAMSCG.....	137	HC5015.....	414	HC90172.....	411
HA90101.5.....	411	HAMSCG3.....	137	HC5016.....	414	HC90181.5.....	411
HA90102.....	411	HAMSCG4.....	137	HC5017.....	414	HC90182.....	411
HA90111.5.....	411	HATP6.....	406	HC5018.....	414	HC90671.5.....	411
HA90112.....	411	HATP7.....	406	HC5106.....	414	HC90672.....	411
HA90121.5.....	411	HATP8.....	406	HC5107.....	414	HCAD10.....	403
HA90122.....	411	HATP9.....	406	HC5108.....	414	HCAD12.....	403
HA90131.5.....	411	HATP10.....	406	HC5109.....	414	HCAD14.....	403
HA90132.....	411	HATP11.....	406	HC5110.....	414	HCAD16.....	403
HA90141.5.....	411	HATP12.....	406	HC5111.....	414	HCAD18.....	403
HA90142.....	411	HATP13.....	406	HC5112.....	414	HCCTP6.....	407
HA90151.5.....	411	HATP14.....	406	HC5113.....	414	HCCTP7.....	407
HA90152.....	411	HATP15.....	406	HC5114.....	414	HCCTP8.....	407
HA90161.5.....	411	HATP16.....	406	HC5115.....	414	HCCTP9.....	407

HCCTP10.....	407	HCSS2416.....	417	HMMS14.....	193	HPBL6.....	310
HCCTP11.....	407	HCTF122410.....	416	HMMS18.....	193	HPBL8.....	310
HCCTP12.....	407	HCTF122415.....	416	HMOST1115.....	264	HPBL12.....	310
HCCTP13.....	407	HCTF122420.....	416	HMOST1317.....	264	HPBL18.....	310
HCCTP14.....	407	HCTP6.....	406	HMOST1520.....	264	HPCH4.....	310
HCCTP15.....	407	HCTP7.....	406	HMOV1418.....	264	HPCH6.....	310
HCCTP16.....	407	HCTP8.....	406	HMOV1621.....	264	HPCH8.....	310
HCCTP17.....	407	HCTP9.....	406	HMPB12.....	369	HPCH12.....	310
HCCTP18.....	407	HCTP10.....	406	HMPB20.....	369	HPCH18.....	310
HCCTP19.....	407	HCTP11.....	406	HMPLUGS.....	154	HPG4.....	310
HCCTP20.....	407	HCTP12.....	406	HMPRR3.....	294	HPG6.....	310
HCDEP6.....	409	HCTP13.....	406	HMPRS3.....	294	HPG8.....	310
HCDEP7.....	409	HCTP14.....	406	HMRD08.....	264	HPG12.....	310
HCDEP8.....	409	HCTP15.....	406	HMRD12.....	264	HPG18.....	310
HCDEP9.....	409	HCTP16.....	406	HMRD16.....	264	HPP7.....	426
HCDEP10.....	409	HCTP17.....	406	HMRRSET.....	294	HPP16.....	426
HCDEP11.....	409	HCTP18.....	406	HMRST1301.....	266	HS2.....	139
HCDEP12.....	409	HCTP19.....	406	HMRST1401.....	266	HS3.....	139
HCDEP13.....	409	HCTP20.....	406	HMRST1601.....	266	HS4.....	139
HCDEP14.....	409	HDD94.....	425	HMRST1801.....	266	HS8.....	139
HCDEP15.....	409	HDS95.....	425	HMRST2001.....	266	HSC2.....	139
HCDEP16.....	409	HDUT975.....	388	HMRST2201.....	266	HSC3.....	139
HCDEP17.....	409	HDUT1200.....	388	HMRT247.....	266	HSC4.....	139
HCDEP18.....	409	HDUT1600.....	388	HMRT712.....	265	HSC8.....	139
HCDS108.....	417	HDWS2.....	138	HMRT814.....	265	HTSH1.....	51
HCDS1410.....	417	HDWS5.....	138	HMRT1019.....	265	HTSH3.....	51
HCDS1712.....	417	HGWC1.....	362	HMRT1322.....	265	HTSH5.....	51
HCHBC1.....	314	HM1LAD.....	193	HMRT1611.....	266	HV3.....	340, 342
HCHD1.....	314	HM6TNG.....	193	HMSP2.....	154	I9540.....	425
HCHL1.....	314	HM8TNG.....	193	HMSP1813.....	263	IBT65.....	299-303
HCHL2.....	314	HM9SPN.....	193	HMSP2618.....	263	IBT125.....	301, 302
HCHR1.....	314	HM10SL.....	193	HMSPH2.....	123	IBT126.....	299-303
HCHS1.....	314	HM10SPO.....	193	HMSPH4.....	123	IBT200.....	299-303
HCLP12.....	417	HM11CMF.....	193	HMSPT3.....	123	IS13.....	281
HCLP16.....	417	HM11FK.....	193	HMSPT5.....	123	IS18.....	282
HCLP24.....	417	HM12NOT.....	193	HMSQ12.....	265	IS734.....	358
HCR86.....	403	HM12PAS.....	193	HMSQ14.....	265	IS900.....	358
HCR137.....	403	HM12SL.....	193	HMSQ16.....	265	ISPI8.....	282
HCR148.....	403	HM12SOL.....	193	HMSQ18.....	265	ISSB4.....	370
HCR168.....	403	HM14KN.....	193	HMSQ20.....	265	ISSB6.....	370
HCSQ610.....	416	HMBAR8.....	373	HMSQ22.....	265	ISW2.....	390
HCSQ615.....	416	HMBAR9.....	128	HMSR6.....	368	ISW3.....	390
HCSQ620.....	416	HMBV1.....	123	HMSR7.....	368	IT400.....	127
HCSQ810.....	416	HMCB14.....	340	HMSR8.....	368	IT700.....	127
HCSQ815.....	416	HMCC14.....	340	HMSRSPH2.....	123	IT878.....	388
HCSQ820.....	416	HMCD4.....	371	HMSRSPH3.....	123	ITPI213.....	441
HCSQ1010.....	416	HMCD5.....	371	HMSSQPH2.....	123	ITPI222.....	441
HCSQ1015.....	416	HMCD6.....	371	HMST10.....	263	ITPI238.....	441
HCSQ1020.....	416	HMCM2.....	123	HMST12.....	263	ITPI246.....	441
HCSQ1210.....	416	HMCS14.....	340	HMST20.....	263	ITPI413.....	441
HCSQ1215.....	416	HMDOB19149.....	369	HMTB14.....	341	ITPI422.....	441
HCSQ1220.....	416	HMDWB14.....	268	HMTB16.....	341	ITPI438.....	441
HCSQ1410.....	416	HMDWB19.....	268	HMTC14.....	341	ITPI446.....	441
HCSQ1415.....	416	HMJ4.....	66	HMTC16.....	341	ITPI713.....	441
HCSQ1420.....	416	HMJ5.....	66	HMTS14.....	341	ITPI722.....	441
HCSQ1610.....	416	HMJ6.....	66	HMTS16.....	341	ITPI738.....	441
HCSQ1615.....	416	HMMJ1.....	66	HMWB.....	364	ITPI746.....	441
HCSQ1620.....	416	HMMJ2.....	66	HMWBSTND.....	364	ITPI913.....	441
HCSS12.....	417	HMMJ3.....	66	HMWC75.....	363	ITPI922.....	441
HCSS14.....	417	HMMJ4.....	66	HMWP44.....	115	ITPI938.....	441
HCSS16.....	417	HMMJ5.....	66	HMWP64.....	115	ITPI946.....	441
HCSS248.....	417	HMMS10.....	193	HMWP85.....	115	ITS6.....	194
HCSS1411.....	417	HMMS12.....	193	HMWP97.....	115	J201.....	352
HCSS1812.....	417	HMMS13.....	193	HPBL4.....	310	J202.....	352



J202A.....	352	JUICE1.....	188	LFTBW11.....	222	MB1.....	136
J203.....	352	JUICE2.....	188	LFTBW12.....	224	MB3.....	136
J204.....	352	JUICE3.....	185	LFTBW16.....	224	MB4.....	136
J205.....	352	JUICE4.....	185	LFTD3.....	251	MB14.....	235
J206.....	352	JUICE5.....	187	LFTD4.....	251	MB17.....	235
J208.....	352	JUICE6.....	186	LFTD8.....	223, 251	MB21.....	235
J212.....	352	JUICE12.....	186, 187	LFTD11.....	223, 251	MB25.....	235
J214.....	352	KBB5.....	85	LFTD12.....	223, 251	MB93.....	60
J222.....	352	KBB7.....	85	LFTD135.....	251	MB171.....	235
J263.....	352	KBB9.....	85	LFTPBI1.....	223	MBM2.....	258, 448
J266.....	352	KBC6.....	174	LFTPBI2.....	223	MBM3.....	258, 448
JBASE1.....	185	KBC10.....	174	LFTPBI3.....	223	MBM4.....	258, 448
JBASE2.....	185	KBC12.....	174	LFTPWI1.....	223	MBM180.....	258, 448
JBASE5.....	185	KBC20.....	174	LFTPWI2.....	223	MBSB11.....	259, 447
JBASE6.....	185	KBK5.....	85	LFTPWI3.....	223	MBSB17.....	259, 447
JBASE7.....	185	KBK7.....	85	LFTPW22.....	225	MBSB20.....	259, 447
JBASEA8.....	186	KBK9.....	85	LFTPW24.....	225	MBW93.....	61
JBASEM9.....	186	KNF2.....	59	LFTTSB17.....	225	MC41.....	60
JBASEMEL8.....	185, 368	KNF3.....	59	LFTTSRRB.....	225	MC61.....	60
JBOD5.....	187	KNF4.....	59	LFTTSRRS.....	225	MC81.....	60
JBOD12.....	187	KNF6.....	59	LFTTSW17.....	225	MCADDY.....	150, 429
JC8.....	73, 342	KNF7.....	59	LFTW63.....	223	MCB10GM.....	17
JC11.....	73, 342	KNF8.....	59	LFTW65.....	223	MCB10GR.....	17
JC12.....	73, 342	KSMC6.....	174	LFTW67.....	223	MCB10MA.....	17
JC14.....	73, 342	KSMC10.....	174	LGJ6.....	65	MCB10WH.....	17
JC16.....	73, 342	KSMC12.....	174	LGJ8.....	64, 65	MCB12GM.....	17
JCOV1.....	188	KSMC20.....	174	LGJ24.....	64, 65	MCB12GR.....	17
JCOV3.....	185	L210.....	379	LGJ40.....	64, 65	MCB12MA.....	17
JCOV4.....	185	L215.....	379	LGMB3.....	67	MCB12WH.....	17
JCOV6.....	169	L220.....	379	LGMB16.....	67	MCB16GM.....	17
JCOV8.....	187	L1101.....	379	LGMB68.....	67	MCB16GR.....	17
JCOV12.....	187	L1102.....	379	LK50.....	316	MCB16MA.....	17
JFAUC4.....	188	L1103.....	379	LMJ1622.....	66	MCB16WH.....	17
JFAUC5.....	185	L1104.....	379	LMJ1785.....	66	MCB24GM.....	17
JFAUC8.....	169, 187	L1105.....	379	LN722.....	160	MCB24GR.....	17
JG1.....	352	L1106.....	379	LNC602.....	160	MCB24MA.....	17
JG2.....	352	L1107.....	379	LPITP1413.....	443	MCB24WH.....	17
JG2A.....	352	L1108.....	379	LPITP1422.....	443	MCB36GM.....	17
JG3.....	352	L1112.....	379	LPITP1438.....	443	MCB36GR.....	17
JG4.....	352, 356	L11005.....	379	LPITP1446.....	443	MCB36MA.....	17
JG5.....	352, 356	L11015.....	379	LPLT10.....	90	MCB36WH.....	17
JG12.....	352	LBO27.....	374	LPLTG10.....	90	MCB300.....	121
JG14.....	352	LDCC16.....	106	LRGJ6.....	65	MCB500.....	121
JG22.....	352	LDCC17.....	106	LSB3.....	359	MCBPPBOXAN.....	323
JG63.....	352	LDCC18.....	106	LSBO.....	359	MCBPPBSS.....	323
JGB4.....	356	LDLB2613.....	95	LT12.....	386	MCBRRPBL.....	323
JGB5.....	356	LDLC1362.....	95	LT12ST.....	386	MCC300.....	121
JGG4.....	356	LFY43.....	90	LT14.....	386	MCC500.....	121, 122
JGG5.....	356	LFY44.....	90	LT14P.....	386	MCCRRPBL.....	323
JMART15.....	339	LFY54.....	90	LT14ST.....	386	MCCRLSBL.....	323
JREP3.....	188	LFY55.....	90	LT20.....	386	MCG300.....	121
JREP4.....	185	LFY43.....	90	LT198.....	386	MCG500.....	121
JREP5.....	185	LFY44.....	90	LWUS779.....	277, 433	MCHB125.....	315
JREP6.....	169	LFY45.....	90	LWUSR.....	277, 433	MCHW125.....	315
JS6.....	359	LFY46.....	90	LX306.....	147, 428	MCL4.....	382
JSTRN6.....	188	LFTB63.....	223	LX307.....	147, 428	MCL10.....	382
JSTRN8.....	187	LFTB65.....	223	M30SP.....	150, 429	MCL12.....	382
JSTRN12.....	187	LFTB67.....	223	M312T.....	150, 429	MCL13.....	382
JTUBE3.....	185	LFTBB8.....	222	M316T.....	150, 429	MCL14.....	382
JTUBE4.....	185	LFTBB9.....	222	M317T.....	150, 429	MCL75.....	382
JTUBE5.....	188	LFTBB12.....	224	MACD3.....	172	MCL125.....	382
JTUBE6.....	169	LFTBB16.....	224	MACTOP.....	172	MCL150.....	382
JTUBE8.....	187	LFTBW8.....	222	MART1.....	339	MCL175.....	382
JTUBE12.....	187	LFTBW9.....	222	MAW10.....	355	MCL200.....	382

MCP6GM.....	17	MELR9.....	48, 209	MMOB1.....	140	MRF450BL.....	143
MCP6GR.....	17	MELR11.....	48, 209	MMOB2.....	140	MRF450W.....	143
MCP6MA.....	17	MELRC3.....	209	MMOB3.....	140	MRP7CL.....	29
MCP6WH.....	17	MELSC15.....	143	MMOB25.....	140	MRP7TC.....	29
MCP9GM.....	17	MELSC20.....	143	MMP6.....	140	MRP9CL.....	29
MCP9GR.....	17	MELSCB21.....	143	MMP8.....	140	MRP9TC.....	29
MCP9MA.....	17	MELSCB51.....	143	MP6.....	48	MRP11CL.....	29
MCP9WH.....	17	MELSL52.....	211	MP7.....	48	MRP11TC.....	29
MCP11GM.....	17	MELSL82.....	211	MP9.....	48	MRP53.....	55
MCP11GR.....	17	MELSL92.....	211	MP11.....	48	MRPS45.....	55
MCP11MA.....	17	MELSL112.....	211	MP1116.....	449	MRPT3CL.....	29
MCP11WH.....	17	MELSQ6.....	209	MPI217.....	449	MRPT3TC.....	29
MCP12GM.....	17	MELSQ8.....	209	MPI222.....	449	MRPT4CL.....	29
MCP12GR.....	17	MELSQ10.....	209	MPI318.....	449	MRPT4TC.....	29
MCP12MA.....	17	MELSQ53.....	210	MPI419.....	449	MRPT6CL.....	29
MCP12WH.....	17	MELSQ73.....	210	MPI424.....	449	MRPT6TC.....	29
MCR72.....	60	MELSQ94.....	210	MPI520.....	449	MRS150BL.....	143
MCRW72.....	61	MELSQ117.....	210	MPI621.....	449	MRS150W.....	143
MCTRBPBL.....	323	MESA72C.....	170	MPI626.....	449	MRS200BL.....	99, 143
MCTRLSBL.....	323	MESA72H.....	170	MPI722.....	449	MRS200W.....	99, 143
MCW4.....	382	MESA91C.....	170	MPI823.....	449	MRS300BL.....	143
MCW10.....	382	MESA91H.....	170	MPI826.....	449	MRS300W.....	143
MCW12.....	382	MESABUCH13.....	171	MPCUT4.....	439	MRS400BL.....	143
MCW13.....	382	MESABUSH13.....	171	MPCUT6.....	439	MRS400W.....	143
MCW14.....	382	MFP41.....	60	MPL4.....	54	MRS600BL.....	143
MCW41.....	61	MFP81.....	60	MPL8.....	54	MRS600W.....	143
MCW61.....	61	MFPW41.....	61	MPL14.....	54	MRSW6.....	218
MCW75.....	382	MFPW81.....	61	MPL24.....	54	MRSW9.....	218
MCW81.....	61	MFRYBSKT.....	89	MPLA.....	241	MRSW12.....	218
MCW125.....	382	MG578.....	351	MPLB.....	241	MRSW13.....	218
MCW150.....	382	MGC20.....	345	MPLW.....	241	MRW615.....	218
MCW175.....	382	MGC25.....	345	MPNS.....	439	MRW815.....	218
MCW200.....	382	MGD20.....	345	MPS10.....	355	MRW1215.....	218
MDLR7.....	355	MGD25.....	345	MPS12.....	386	MSB2.....	259
MDLR10.....	355	MGL20.....	345	MPS14.....	54	MSB3.....	259
MDT9B.....	275	MGL25.....	345	MPS22.....	54	MSB4.....	259
MDT9W.....	275	MGLA3.....	150, 429	MPSB16.....	259, 447	MSC8.....	33, 141
MDT12B.....	275	MGLCS.....	150, 429	MPT12.....	386	MSCR2.....	142
MDT12W.....	275	MH220.....	308	MRB6CL.....	29	MSCRW2.....	142
MEL5.....	212	MH243.....	308	MRB6TC.....	29	MSCSB3.....	142
MEL7.....	212	MHSC6.....	312	MRB10CL.....	29	MSCSW3.....	142
MEL9.....	212	MICH5.....	75	MRB10TC.....	29	MSEA10B.....	274
MEL12.....	215	MICH10.....	75	MRB13CL.....	29	MSEA10G.....	274
MEL19.....	215	MICH15.....	75, 342	MRB13TC.....	29	MSEA10S.....	274
MEL21.....	215	MICH25.....	75	MRB22CL.....	29	MSEA12B.....	274
MEL22.....	212	MJ16.....	66	MRB22TC.....	29	MSEA12G.....	274
MEL23.....	215	MJ17.....	66, 342	MRCW6.....	218	MSEA12S.....	274
MEL42.....	215	MJ22.....	66	MRCW7.....	218	MSJ3.....	64
MEL43.....	215	MJ85.....	66, 342	MRCW9.....	218	MSJ4.....	64
MEL44.....	215	MLRP9.....	210	MRCW10.....	218	MSJ5.....	64, 286
MEL49.....	215	MLRP13.....	210	MRCW12.....	218	MSP4.....	147
MEL50.....	215	MLRP17.....	210	MRCW13.....	218	MSP61.....	62
MEL148.....	214	MLRP19.....	210	MRDB14.....	220	MSP91.....	62
MEL189.....	214	MLRS9.....	211	MREC13.....	220	MSPW61.....	62
MEL1414.....	214	MLRS12.....	211	MREC21.....	220	MSPW91.....	62
MEL2113.....	214	MLRS16.....	211	MRECB13.....	220	MSQBSKT.....	89
MELBPH.....	142	MLRS21.....	211	MRECB21.....	220	MSSF75.....	383
MELPOT2.....	64	MM12WH.....	17	MRECBSKT.....	91	MSSR74.....	383
MELPOT8.....	64	MM100.....	351	MRF150BL.....	143	MSSS73.....	383
MELPOT14.....	64	MMB3.....	140	MRF150W.....	143	MSTNG5.....	353
MELPOT24.....	64	MMB6.....	140	MRF250BL.....	99, 143	MT6.....	219
MELR5.....	48, 209	MMB9.....	140	MRF250W.....	99, 143	MT8.....	219
MELR6.....	48, 209	MMBH3.....	140	MRF350BL.....	143	MT10.....	219
MELR8.....	48, 209	MMBH7.....	140	MRF350W.....	143	MTB20.....	242



MTB156.....	177, 286	MWW10.....	355	OSC9.....	96	PBSB1512.....	452
MTB159.....	177	N9494.....	425	OSCAR.....	75, 127	PBSL1.....	215, 246
MTB296.....	177	NB30.....	229	OSCAR2.....	75, 127	PBSL2.....	215, 246
MTB298.....	177	NB32.....	229	OSCAR3.....	75, 127	PBSL3.....	215, 246
MTB1512.....	177, 286	NB50.....	229	OVJ1.....	158	PC0600S.....	164
MTB2910.....	177	NB56.....	229	OVJ2.....	158	PC0688S.....	164
MTP10.....	214, 419	NB85.....	229	OVJS.....	158	PC0788S.....	164
MTP12.....	214, 419	NB120.....	229	OWB107.....	254	PC0825S.....	164
MTP14.....	214, 220, 419	NBW30.....	229	OWB116.....	252	PC0875S.....	164
MTP16.....	214, 419	NBW32.....	229	OWB117.....	252	PC0900S.....	164
MTP18.....	214, 419	NBW50.....	229	OWB118.....	252	PC0950R.....	164
MTS20.....	344	NBW56.....	229	OWB129.....	254	PC0988S.....	164
MTS26.....	344	NBW85.....	229	OWB149.....	252	PC1025S.....	164
MTS32.....	344	NBW120.....	229	OWB208.....	253	PC1062E.....	164
MTSH1.....	51	NCB95.....	287	OWB1810.....	253	PC1068R.....	164
MTSH3.....	51	NCS36.....	396	OWB2213.....	253	PC1068S.....	164
MTSH5.....	51	NHS66.....	262	OWBB1.....	255	PC1093E.....	164
MTUB7.....	109	NHS95.....	262	OWBB2.....	255	PC1093R.....	164
MTUB10.....	80	NP14.....	228	OWBB8.....	256	PC1112R.....	164
MTUB12.....	80	NP18.....	228	OWBB9.....	256	PC1112S.....	164
MTUB63.....	80	NP21.....	228	OWBB15.....	256	PC1150S.....	164
MTUB69.....	80	NPW14.....	228	OWBG8.....	256	PC1175R.....	164
MTUB83.....	80	NPW18.....	228	OWBG9.....	256	PC1206R.....	164
MTUB93.....	80	NPW21.....	228	OWBG15.....	256	PC1244R.....	164
MTW6.....	219	NSB1.....	312	OWBS.....	364	PC1250S.....	164
MTW8.....	219	NSB4.....	312	OWLP.....	254	PC1300S.....	164
MTW10.....	219	NSB6.....	312	OWM10.....	237	PC7250.....	437
MTW20.....	242	NSB8.....	312	OWM12.....	237	PC7400.....	437
MW14.....	235	NSB10.....	309	OWM14.....	237	PCA3.....	437
MW17.....	235	NSB12.....	312	OWM17.....	237	PCG2.....	132
MW18.....	234, 285	NSB20.....	309	OWM21.....	237	PCG9.....	383
MW21.....	235	NSB30.....	309	OWM25.....	237	PCI10.....	371
MW24.....	234, 285	NSB40.....	309	OWM171.....	237	PCP12.....	165
MW25.....	235	NSB50.....	309	OWMP.....	254	PCR25.....	118
MW32.....	234, 285	NSC1.....	312	OWP9.....	252, 446	PCR55.....	118
MW171.....	235	NSC4.....	312	OWP12.....	253	PCSC6.....	384
MW1210.....	297	NSC6.....	312	OWP13.....	252, 446	PCSC12.....	384
MW2012.....	297	NSC8.....	312	OWP14.....	253	PCSC24.....	384
MWB11.....	234	NSC10.....	309	OWP15.....	252, 446	PCW2.....	437
MWB12.....	234	NSC12.....	312	OWP17.....	252, 446	PCW4.....	437
MWB14.....	234	NSC20.....	309	OWP18.....	253	PCW5.....	437
MWC57.....	362	NSC30.....	309	OWP157.....	252	PCWH2.....	132
MWC59.....	362	NSC40.....	309	OWP178.....	252	PFB6.....	202
MWMEL12.....	233	NSC50.....	309	OWPB9.....	255	PFB8.....	202
MWMEL19.....	233	NSPDS6.....	380	OWPB16.....	255	PFB10.....	202
MWMEL21.....	233	NSPDS8.....	380	OWPIT54.....	116	PHBS10.....	385
MWMEL23.....	233	NSPDS10.....	380	OWSP.....	254	PHBS14.....	385
MWMSQ5.....	233	NSPDS12.....	380	PB1914.....	452	PHBS16.....	385
MWMSQ7.....	233	NSPDS16.....	380	PB1926.....	452	PIZG3.....	437
MWMSQ9.....	233	NSPDS20.....	380	PBB8.....	204	PIZR2.....	437
MWMSQ11.....	233	NSPDS24.....	380	PBB9.....	204	PIZWI.....	437
MWP4.....	250	NSPDS30.....	380	PBB12.....	204	PKR20.....	438
MWP5.....	250	NSPDS40.....	380	PBB13.....	204	PKS8.....	358
MWP9.....	250	NSPDS50.....	380	PBB135.....	204	PKW8.....	358
MWP12.....	250	O2BWB.....	364	PBBAG19.....	452	PL147.....	436
MWP13.....	250	OBS58.....	102	PBBAG26.....	452	PLA710.....	57
MWP14.....	250	OBS69.....	102	PBBL2.....	119	PLA810.....	57
MWP18.....	251, 285	OBS913.....	102	PBBL4.....	119	PLA912.....	57
MWP24.....	251, 285	OLB9.....	96	PBB09.....	204	PLP147.....	436
MWP32.....	251, 285	OLID.....	75, 127	PBC25.....	118	PMBL8.....	157
MWPC6X2.....	438	OLID2.....	75, 127	PBC45.....	118	PMBL12.....	157
MWPD5.....	251	OLID3.....	75, 127	PBDX1805.....	452	PMG6.....	156
MWPD6.....	251	ORHC1.....	99	PBDX2005.....	452	PMKNOB.....	156, 157
MWR3.....	297	ORH02.....	99	PBL7.....	119	PMSA62.....	156

PMSBA62.....	156	PSBI416.....	421	RC5.....	371	RSG3.....	292	SBDBL85.....	324
PMSBL62.....	157	PSBL.....	119	RCR13.....	220	RSGB3.....	291	SBDM85.....	324
PMSKNOB.....	157	PSD10.....	436	RCR21.....	220	RSGG3.....	291	SBH3.....	82, 261
PMSR62.....	156	PSFSP.....	387	RCRD14.....	220	RSGS3.....	291	SBH5.....	82, 261
PMSS62.....	157	PSGI27.....	436	RD412.....	166	RSH1.....	292	SBH7.....	82, 261
PMSW62.....	156	PSLT2.....	133, 153	REVLUICESQ12.....	169	RSLWCH.....	330	SBH325.....	82, 261
PNS13.....	152	PSLT17.....	133, 153	REVL0SCUI2.....	169	RSM2.....	296	SBH400.....	82, 261
PNS24.....	152	PSP2.....	153	REVLRD20.....	168	RSQB2.....	290	SBH450.....	82, 261
POR9.....	201	PSP4.....	204	REVLRD20BASE.....	168	RSQG2.....	290	SBH575.....	82, 261
POR17.....	201	PSP8.....	204	REVLRT26.....	168	RSR10.....	279, 434	SBHW5.....	306
PORB29.....	134	PSP12.....	204	REVLRT26BASE.....	168	RSR307.....	434	SBL353.....	126
PORB30.....	134	PSPH3.....	126	REVLURN12.....	169	RSR312.....	434	SBN3.....	77
PORD39.....	134	PSPH4.....	126	RFPI8RD.....	168, 172	RSRB.....	279, 434	SBN4.....	77
PORS136.....	203	PSPL8.....	204	RG6.....	289	RSRB3.....	279, 434	SBO154.....	374
PORS140.....	203	PSPL12.....	204	RG7.....	289	RSRB4.....	279, 434	SBP30.....	439
PORS3R.....	132	PSR7.....	435	RG5341.....	376	RSRB7.....	279, 434	SBR5.....	306
PPC2.....	437	PSS12.....	421	RGB7.....	433	RSRB8.....	275	SBS533.....	126
PPC4.....	437	PSS15.....	421	GG7.....	433	RSRBH4.....	279, 434	SBSB135.....	324
PPC5.....	437	PSS77.....	435	RGJ4.....	65	RSRBH7.....	279, 434	SBSBL120.....	324
PPCHIB.....	76	PTBC.....	159	RGJ6.....	65	RSRTBK.....	328	SBSBMNI.....	320
PPCH2N.....	76	PTBR.....	159	RGS7.....	433	RSRTBLC8.....	328	SBSM135.....	324
PPCH3N.....	76	PTC.....	194	RHG1.....	292	RSRTBLC9.....	328	SBW3.....	77
PPCH3R.....	76	PTCC.....	159	RHSSIGNBLK.....	329	RSRTGY.....	328	SBW4.....	77
PPCH4N.....	76, 431	PTCR.....	159	RHSSIGNLSPS.....	329	RSRTLWCH.....	328	SBW5.....	354
PPCHARDWARE.....	437	PTS9.....	194	RM10.....	238	RSRTRD.....	328	SBW7.....	354
PPCNI010.....	76	PTUB87.....	80	RM12.....	238	RSRTRVSBLC4.....	328	SBW9.....	354
PPCNI212.....	76	PW10.....	379	RM13.....	239	RSRTRVSC3.....	328	SBW10.....	354
PPCNI616.....	76	PW12.....	379	RM14.....	238	RSRTRVSGYC2.....	328	SCAR9.....	433
PPK17.....	438	PW14.....	379	RM17.....	238	RSRTRVSRDC1.....	328	SCAT9.....	433
PPL4.....	77	PW16.....	379	RM21.....	238	RSRW8.....	275	SCAW7.....	104, 426
PPL7.....	77	PW18.....	379	RM25.....	238	RSS3.....	292	SCB3.....	72
PPL12.....	77	PWB3.....	130	RM95.....	239	RSSB3.....	279, 434	SCB480.....	103
PPRC76.....	76	PWB45.....	130	RM147.....	239	RSSB7.....	279, 434	SCBL.....	173
PPRN76.....	76	PWBB3.....	130	RM189.....	239	RSSIGNBLK.....	329	SCBM.....	72
PPRN1100.....	76	PWBB10.....	84	RM210.....	239	RSSIGNLSPS.....	329	SCF2.....	173
PPRN1616.....	76, 431	PWBB12.....	84	RM1614.....	239	RSSPH2.....	122	SCG8.....	383
PPRN2121.....	76	PWBB45.....	130	RM2113.....	239	RTSSPH3.....	122	SCH6.....	105
PPRW1010.....	76	PWBC7.....	130	RMB11.....	238	RTWVY1.....	199	SCH7.....	105
PPRW1212.....	76	PWBC8.....	130	RMB12.....	238	RWW8.....	392	SCH8.....	105
PPRW1616.....	76, 431	PWBS4.....	130	RMB14.....	238	S208.....	359	SCHB6.....	105
PPSS837.....	443	PWC7.....	130	RMB59C.....	91	S209.....	359	SCHB7.....	105
PPSS849.....	443	PWC8.....	130	RMB95B.....	91	SAC35.....	313	SCHB8.....	105
PRI8.....	423	PWK19.....	438	ROB2613.....	95	SAC40.....	313	SCM2.....	122
PRP500.....	423	PWRB10.....	84	ROC1362.....	95	SAN300.....	149, 430	SCM3.....	120
PRS2.....	158	PWRB12.....	84	RP5718.....	423	SAN312.....	149, 430	SCM4.....	120
PRS14.....	438	PWS4.....	130	RRB2.....	290	SAN316.....	149, 430	SCM6.....	120
PRS22.....	438	RAM1.....	161	RRG2.....	290	SAN317.....	149, 430	SCMB3.....	120
PRSD3.....	133	RB15.....	135	RS12.....	308	SAN318.....	149, 430	SCMB4.....	120
PS10.....	387, 436	RB25.....	135	RS18.....	308	SAN319.....	149, 430	SCMB6.....	120
PS12.....	386	RBHB975.....	109	RSB1.....	296	SBI.....	260	SCMC3.....	120
PS12ST.....	386	RBHC759.....	109	RSB307.....	434	SB3.....	83, 260	SCMC4.....	120
PS14.....	386	RBHMSG.....	329	RSB312.....	434	SB5.....	83, 260	SCMC6.....	120
PS14P.....	386	RBHSIGNBL.....	327	RSBPBL.....	328	SB7.....	83, 260	SCMG3.....	120
PS125.....	421	RBHSIGNS.....	327	RSC1.....	135	SB325.....	83, 260	SCMG4.....	120
PS127.....	436	RBNB16.....	108	RSC3.....	135	SB400.....	83, 260	SCMG6.....	120
PS196.....	387, 436	RBNB17.....	108	RSC4.....	135	SB450.....	83, 260	SCP8.....	165
PS197.....	387	RBNC26.....	108	RSCLC.....	330	SB575.....	83, 260	SCP65.....	165
PS1116.....	421	RBNC27.....	108	RSCLCHB1.....	330	SBB3.....	77	SCRACK5.....	166
PS1416.....	421	RBR3.....	298	RSCLCHB2.....	330	SBB4.....	77	SCS3.....	72
PS1575.....	421	RBSBL.....	326	RSCLG.....	330	SBBL.....	177	SCSM.....	72
PS19008.....	387	RBSIGNBL.....	327	RSCLG0A1.....	330	SBBS.....	177	SD10.....	150
PS19075.....	387	RBSIGNS.....	327	RSCLG0A2.....	330	SBC5.....	306	SD3511.....	159
PSA105.....	437	RBSS.....	326	RSCLRPCHBL.....	330	SBD5.....	306	SDRCK.....	277, 432
PSB16.....	421	RBVMSG.....	329	RSCLRPGOBL.....	330	SBDB85.....	324	SDRCK4.....	277, 432



SDRCKV4.....	276	SLR8.....	226	SPP326.....	126	SQVY5.....	202	SSP16.....	19, 418
SDRCKV7.....	276	SLS5.....	227	SPPLUGS.....	155	SQVY8.....	202	SSP25.....	75
SDWB40.....	268	SLS6.....	227	SPR725.....	396	SQVY10.....	202	SSP35.....	75
SDWB45.....	268	SLWC2.....	362	SPRV1.....	325	SQVY12.....	202	SSP43.....	75
SDWB55.....	268	SM9.....	354	SPRV2.....	325	SR6063.....	393	SSP61.....	75
SDWC7.....	363	SMA100WT.....	321	SPS11.....	195	SR6073.....	393	SSP120.....	195
SDWP64.....	114	SMA510V4.....	321	SPSSWM2.....	325	SR6083.....	393	SSPH2.....	122
SDWW5.....	363	SMA510V4WT.....	321	SPT14.....	195	SR6093.....	393	SSPH4.....	122
SEA10.....	270	SMA510WT.....	321	SQ600.....	416	SR6103.....	393	SSPT3.....	122
SEA12.....	270	SMB3.....	15, 138	SQ610.....	416	SRBNC1.....	107	SSPT5.....	122
SEA14.....	270	SMB4.....	15, 138	SQ615.....	416	SRBNC2.....	107	SSQ53.....	267
SEA16.....	270	SMB5.....	15, 138	SQ620.....	416	SRCH4.....	315	SSQ73.....	267
SEA18.....	270	SMB6.....	15	SQ800.....	416	SRCH125.....	315	SSQ94.....	267
SEA20.....	270	SMB10.....	15	SQ810.....	416	SRG3.....	289	SSQ117.....	267
SECSTN5.....	320, 321	SMP4.....	15	SQ815.....	416	SRG4.....	289	SSQH53.....	267
SGLR.....	150	SMP6.....	15	SQ820.....	416	SRS3.....	289	SSQH73.....	267
SGSC16.....	175	SMP9.....	15	SQ1000.....	416	SRS4.....	289	SSQH94.....	267
SGSC17.....	175	SMP11.....	15	SQ1010.....	416	SS59.....	86	SSQH117.....	267
SGSC26.....	175	SMS1.....	307	SQ1015.....	416	SS92.....	86	SSR4.....	294
SHFF12.....	192	SMSC4.....	349	SQ1020.....	416	SS782.....	388	SSR5.....	306
SHFL9.....	192	SMSC8.....	349	SQ1200.....	416	SSB28.....	101	SSR8.....	294
SHFPS11.....	192	SMSR4.....	349	SQ1210.....	416	SSB75.....	392	SSR12.....	294
SHFSA9.....	192	SMSR8.....	349	SQ1215.....	416	SSB96.....	101	SSRT962.....	91
SHFSP7.....	192	SN60.....	160	SQ1220.....	416	SSB150.....	392	SSSK.....	59
SHFSP12.....	192	SNC1.....	312	SQ1400.....	416	SSB200.....	392	SST10.....	262
SHFSS12.....	192	SNF700.....	160	SQ1410.....	416	SSB300.....	392	SST12.....	262
SHFT6.....	192	SNT612.....	160	SQ1415.....	416	SSB400.....	392	SST14.....	262
SHFT9.....	192	SOCH.....	317	SQ1420.....	416	SSB500.....	392	SSUS1.....	277, 433
SHFT11.....	192	SP4.....	155	SQ1600.....	416	SSB800.....	392	ST2.....	146, 427
SHSP20.....	55	SP6.....	155	SQ1610.....	416	SSB1300.....	392	ST10.....	262
SHSP21.....	55	SP8MN.....	63	SQ1615.....	416	SSB1600.....	392	ST12.....	262
SHSP32.....	55	SP8SH.....	63	SQ1620.....	416	SSB2000.....	392	ST20.....	262
SHSP40.....	55	SP10MN.....	63	SQB55.....	201	SSBT11.....	361	STC2.....	359
SHSP41.....	55	SP10SH.....	63	SQB88.....	201	SSBT14.....	361	STC4.....	359
SHSP53.....	55	SP29.....	155	SQFBBL.....	87	SSBV1.....	122	STH6.....	368
SHT8.....	80	SP35.....	155	SQFBCN.....	87	SSC5.....	306	STH8.....	368
SHT9.....	80	SP125.....	152	SQFBCN10.....	87	SSC15.....	136	STH14.....	368
SHT10.....	80	SP126.....	152	SQFBSS.....	87	SSC17.....	385	STH16.....	368
SHT17.....	80	SPC.....	125	SQGB6.....	92	SSC18.....	385	STONE12.....	420
SIGNC3.....	306	SPC2.....	125	SQGB10.....	92	SSC19.....	385	STONE13.....	420
SIGNC0.....	306	SPC3.....	125	SQGB12.....	92	SSC25.....	136	STONE14.....	420
SIGNCR1.....	306	SPDB1.....	155	SQGS6.....	92	SSCH4.....	315	STONE15.....	420
SIGND4.....	306	SPDB33.....	155	SQGS8.....	92	SSCH125.....	315	STP10.....	78, 418
SIGNHT1.....	306	SPDG11.....	155	SQGS10.....	92	SSD5.....	306	STP12.....	78, 418
SIGNIT2.....	306	SPDG33.....	155	SQGS12.....	92	SSEA10.....	270	STP14.....	78, 418
SIGNM8.....	306	SPDX11.....	155	SQND7.....	200	SSEA12.....	270	STP16.....	78, 418
SIGNR6.....	306	SPDX22.....	155	SQND9.....	200	SSEA14.....	270	STS2.....	288
SIGNS7.....	306	SPDX33.....	155	SQND11.....	200	SSEA16.....	270	STS3.....	288
SIGNSK9.....	306	SPH.....	125	SQND13.....	200	SSEA18.....	270	STUB10.....	80
SIGNW5.....	306	SPLB7.....	151	SQND15.....	200	SSFC7.....	87	STUB12.....	80
SKS514.....	389	SPLBCAP.....	151	SQP10.....	214	SSHW5.....	306	STUB20.....	80, 369
SKS714.....	389	SPM4.....	155	SQP12.....	214	SSKNF8.....	59	STUB63.....	80
SL74.....	227	SPN2.....	381	SQP16.....	214	SSKNF9.....	59	STUB69.....	80
SL76.....	227	SPN3.....	381	SQSC15.....	133, 200	SSMS9.....	57	STUB83.....	80
SL96.....	227	SPN4.....	381	SQSC20.....	133, 200	SSP2.....	154	STUB87.....	80
SLFTD8.....	349	SPN5.....	381	SQSC30.....	133, 200	SSP4.....	19, 418	STUB93.....	80
SLL1.....	195	SPN6.....	381	SQSC40.....	133, 200	SSP6.....	19, 418	SVHF.....	191
SLL2.....	195	SPN8.....	381	SQSSPH2.....	122	SSP8.....	19, 418	SVHF10.....	191
SLL4.....	195	SPNP2.....	381	SQVL712.....	199	SSP9.....	19, 418	SVHL.....	191
SLL6.....	195	SPNP3.....	381	SQVL914.....	199	SSP10.....	19, 418	SVHML.....	191
SLPI21.....	195	SPNP4.....	381	SQVY1.....	133, 202	SSP12.....	19, 418	SVHP10.....	191
SLR3.....	226	SPNP5.....	381	SQVY2.....	133, 202	SSP13.....	19, 418	SVHSA10.....	191
SLR5.....	226	SPNP6.....	381	SQVY3.....	133, 202	SSP14.....	19, 418	SVHSP.....	191
SLR6.....	226	SPNP8.....	381	SQVY4.....	133, 202	SSP15.....	19, 418	SVHSP6.....	191

SVHSP10.....	191	THMT3.....	53	TTMC3.....	307	UT707.....	353, 388	WLD11.....	203
SVHSS.....	191	THMT5.....	53	TTMEL3.....	282	UT975.....	388	WLD13.....	203
SVHSS10.....	191	THMW1.....	53	TTREC3.....	282	UT1200.....	388	WLD15.....	203
SVHT1.....	191	THMW3.....	53	TTRS3.....	282	UT1600.....	388	WMEL19.....	242
SVHT2.....	191	THMW5.....	53	TTRSMEL7.....	282	WB8C.....	363	WMEL21.....	242
SVHT6.....	191	THN61.....	159	TTS2319.....	288	WB9.....	363, 365	WMEL23.....	242
SWILAD.....	194	THOV19.....	267	TTSB3.....	307	WB32.....	111, 348	WP68.....	113
SW4.....	269, 362	THRC21.....	267	TTSVG3.....	307	WB33.....	111, 348	WP100.....	113
SW4C.....	363	THRD17.....	267	TV3.....	85	WB34.....	111, 348	WPH45153.....	443
SW6TNG.....	194	THW8.....	53	TV4.....	85	WB35.....	111, 348	WPM8.....	157
SW9SPN.....	194	TIM1.....	127	TV6.....	85	WBB.....	323	WPM12.....	157
SW9TNG.....	194	TIM2.....	127	TV8.....	85	WBB9.....	100	WPM18.....	157
SW10SP0.....	194	TLSP1219.....	281, 435	TV9.....	85	WBB11.....	100	WPM562.....	157
SW12PAS.....	194, 387	TMW9.....	217	TWBB53.....	243	WBBM.....	100	WPSF33.....	117
SW12SL.....	194	TMW13.....	217	TWBB73.....	243	WBBR80.....	100	WPSF67.....	117
SW12SOL.....	194	TMW16.....	217	TWBB94.....	243	WBBS.....	100	WRPC5713.....	423
SWB.....	364	TONG2.....	196	TWBB124.....	243	WBBV90.....	100	WRPC5715.....	423
SWBSTND.....	364	TONG3.....	196	TWBREC.....	243	WBC34.....	111, 348	WRPC5718.....	423
SWC48.....	362	TOPPNS1.....	152	UBR5GE.....	13	WBC36.....	111, 348	WRPCHARDWARE.....	423
SWCH.....	317	TP6.....	406	UBR5M0.....	13	WBC705.....	103	WSB69.....	101
SWSC.....	364	TP7.....	406	UBR10GE.....	13	WBCAP.....	111, 348	WSB82.....	101
SZ56.....	354	TP8.....	406	UBR10M0.....	13	WBCC6.....	106	WSBL15.....	206
T10SDC.....	383	TP9.....	406	UBR16GE.....	13	WBCC7.....	106	WSBM11.....	206
T10SDF.....	383	TP10.....	406	UBR16M0.....	13	WBCC8.....	106	WSLB27.....	206
T10SDM.....	383	TP11.....	406	UBR24GE.....	13	WBCLINER.....	97, 103	WSMB17.....	206
T80061.5.....	413	TP12.....	406	UBR24M0.....	13	WBP34.....	112, 348	WSP15.....	206
T80062.....	413	TP13.....	406	UBR32GE.....	13	WBPCAP.....	112, 348	WSPR2B.....	108
T80071.5.....	413	TP14.....	406	UBR32M0.....	13	WBS24.....	365	WSPR3C.....	108
T80072.....	413	TP15.....	406	UBR48GE.....	13	WBSM42.....	365	WSRT21.....	206
T80081.5.....	413	TP16.....	406	UBR48M0.....	13	WBW80.....	101	WTBA6.....	299
T80082.....	413	TP17.....	406	UBRT10GE.....	13	WBW96.....	101	WTBA10.....	299
T80091.5.....	413	TP18.....	406	UBRT10M0.....	13	WBWBL4060.....	324	WTBA12.....	299
T80092.....	413	TP19.....	406	UBRT16GE.....	13	WBWBL6080.....	324	WTBA20.....	299
T80101.5.....	413	TP20.....	406	UBRT16M0.....	13	WC40.....	112	WTBL6.....	301
T80102.....	413	TPREC3.....	282	UBRT24GE.....	13	WCBA4.....	131, 299	WTBL10.....	301
T80112.....	413	TPRS.....	356	UBRT24M0.....	13	WCBA7.....	131, 299	WTBL12.....	301
T80121.5.....	413	TR18.....	397	UBS10GE.....	12	WCBL4.....	131, 301	WTBL20.....	301
T80122.....	413	TR24.....	397	UBS10M0.....	12	WCBL7.....	131, 301	WTSB33.....	162
T80132.....	413	TR30.....	397	UBS16GE.....	12	WCFS462.....	362	WTSB40.....	162
T80142.....	413	TR36.....	397	UBS16M0.....	12	WCMA.....	360	WTSM31.....	162
T80162.....	413	TR48.....	397	UBS60GE.....	12	WCRP.....	360	WTSM38.....	162
TAGA6WT.....	319	TRPZ12.....	217	UBS60M0.....	12	WCS137.....	360	WTSW32.....	162
TAGA7WT.....	319	TRPZ18.....	217	UM12GE.....	12	WCS867.....	360	WTSW39.....	162
TAGA8WT.....	319	TRPZ23.....	217	UM12M0.....	12	WCS871.....	360	WTV6.....	300
TASLG.....	280	TRSD1815.....	162	UPLR10GE.....	13	WCSB415.....	360	WTV10.....	300
TASMED.....	280	TRSH12.....	397	UPLR10M0.....	13	WCV4.....	131, 300	WTV12.....	300
TASSM.....	280	TRSH18.....	397	UPLS10GE.....	12	WCV7.....	131, 300	WTV20.....	300
TBABLA5.....	320	TRSH24.....	397	UPLS10M0.....	12	WCVL.....	300	WVAF.....	191
TBABLA6.....	320	TRV875.....	59	UPR6GE.....	13	WCVS.....	300	WVAF10.....	191
TBABLA7.....	320	TRV053.....	59	UPR6M0.....	13	WCW69.....	101	WVAL.....	191
TBABLA8.....	320	TRV085.....	59	UPR9GE.....	13	WCW81.....	101	WVAML.....	191
TF122410.....	416	TRVR5.....	59	UPR9M0.....	13	WFB3.....	201	WVAP10.....	191
TF122415.....	416	TRVR8.....	182	UPR11GE.....	13	WFB6.....	201	WVASA10.....	191
TF122420.....	416	TRVR10.....	182	UPR11M0.....	13	WFB9.....	201	WVASP.....	191
TG8.....	196, 353	TRVR675.....	59	UPS6GE.....	12	WFB12.....	201	WVASP6.....	191
TGP8.....	196, 353	TRVS6.....	59	UPS6M0.....	12	WIB80.....	93	WVASP10.....	191
TGS6.....	196, 352	TSC7.....	147, 430	UPS9GE.....	12	WIB100.....	93	WVASS.....	191
TGS8.....	196, 352	TSCB2.....	142	UPS9M0.....	12	WIB120.....	93	WVASS10.....	191
TGS9.....	196, 352	TSF7.....	147, 430	UPS11GE.....	12	WICS34.....	365	WVAT1.....	191
TGS12.....	196, 352	TSFP10.....	393	UPS11M0.....	12	WIR3.....	101	WVAT2.....	191
THMB1.....	53	TSH1.....	51	USCR2GE.....	13, 141	WIR4.....	101	WVAT6.....	191
THMB3.....	53	TSH3.....	51	USCR2M0.....	13, 141	WISS8.....	93		
THMB5.....	53	TSH5.....	51	USCS2GE.....	12, 141	WISS10.....	93		
THMT1.....	53	TTDB2.....	87	USCS2M0.....	12, 141	WISS12.....	93		



**A**

ACACIA WOOD.....	53, 104, 119, 151, 186, 240-241, 257, 355, 368, 285, 426, 437, 446
ALTERNATIVE DRINKING VESSELS.....	342
ANODIZED PANS.....	393, 403-417, 422
ANTIQUE COPPER.....	128, 338, 350, 372
ASH WOOD.....	248-249
AU GRATIN SERVICE.....	161

**B**

BAGS.....	76-77, 85, 450-452
BALTI DISHES.....	56
BAMBOO.....	131, 142, 156, 241, 244-247, 298-299, 317, 322-323, 343
BAR BOARDS.....	359
BAR MATS.....	375
BAR SPOONS.....	357-358
BAR STRAINERS.....	359
BAR TOOLS.....	354-359
BAR TRAYS.....	361
BARRIER SYSTEMS.....	326-330
BASKETS.....	81, 86-103, 109, 126, 243, 301, 389
BASTING COVERS.....	398
BEAKERS.....	346
BENTO BOXES.....	46-48
BEVERAGE TUBS.....	302-305, 367-369
BILL/CHECK PRESENTERS.....	323
BISCUIT CUTTERS.....	393
BITTERS BOTTLES.....	345
BOTTLE OPENERS.....	359, 374
BOTTLE STOPPERS.....	110, 347, 374
BOWLS.....	12-15, 17, 22-25, 28-29, 33, 35, 38-39, 42-43, 45-48, 60-61, 78, 82-83, 119, 138, 140, 199-202, 206-213, 216, 218, 220-227, 229-231, 233-234, 238, 241, 247, 260-261, 264, 267-269, 282, 369, 392
BRUSHES.....	390-391, 453
BUBBLE POPPERS.....	439
BUFFETWARE.....	190-197
BURGER MOLD.....	390
BUTTER WARMER.....	161

**C**

CADDIES.....	104-109, 128-131, 150-151, 299-301, 372-373, 426, 429, 433
CAKE PANS/RINGS.....	393-394

CAKE STANDS & COVERS.....	160, 223, 250-251
CALL BELL.....	396
CAR PANS.....	405
CARAFES.....	110-112, 347-348
CARD SIGNS, CARDS & HOLDERS.....	306-319
CAST IRON.....	58-59, 182-183
CEDAR PLANKS.....	390
CHAFERS.....	168-174
CHALK MARKERS.....	321
CHALK MARKER STENCILS.....	320
CHALKBOARD CARDS.....	319
CHAMPAGNE SERVICE.....	363-365
CHECK SPINDLES.....	396
CHEESE GRATERS.....	383, 436
CHEESE KNIVES.....	197
CHEESE PAPER.....	77
CHEMISTRY COLLECTION.....	346
CHINA CAP STRAINERS.....	383
COCKTAIL SHAKERS.....	350-351
COCKTAIL SMOKING DOME.....	349
COFFEE CADDIES.....	128-129, 372-373
COFFEE URNS.....	169, 171, 189
COFFEE/TEA SERVICE.....	117-130
COLD CELL.....	177
CONDIMENT HOLDERS.....	371
CONDIMENT RACKS.....	104-109, 287
CORKSCREWS.....	360
CRATES.....	125, 131, 174, 255, 256, 297, 299-301
CTP PANS.....	407
CULINARY BASKETS.....	389
CUTTERS, BISCUIT & DOUGHNUT.....	393

**D**

DEEP DISH PANS.....	408-414, 416-417
DEEP SELF-STACKING PANS.....	414
DELIVERY BAGS.....	450-452
DETROIT-STYLE PANS.....	417
DINNERWARE.....	10-48
DISHERS.....	380
DOCKERS.....	424-425
DOMES.....	160, 223, 251, 349
DOUBLE-WALL DRINKING VESSELS.....	339-341
DOUGH CUTTERS & SCRAPERS.....	385, 423
DOUGHNUT CUTTER.....	393

DREDGE.....	383
DRINKWARE.....	332-335
DRIP TRAYS.....	169, 189, 275

**E**

EGG RINGS & SLICER.....	391
ENAMELWARE.....	78

**F**

FLAME GUARDS.....	180
FLIGHT BOARDS.....	244, 343
FOLDING BEVERAGE FRAMES.....	174
FRENCH FRY SCOOPS.....	384
FRY CUPS.....	68-75
FRY PANS.....	55, 58, 60-61, 132, 182-183, 378
FRY PAPER.....	76
FUNNELS.....	376, 396

**G**

GALVANIZED.....	74, 78, 80, 109, 125, 302, 369, 418
GLASS.....	65-67, 110, 119, 146-152, 158, 207, 289, 342, 345-347, 351, 427-430
GLASS RACKS.....	376
GRAVY BOATS.....	144
GRIDDLES.....	58, 175, 178-181, 183

**I**

ICE BUCKETS.....	370
ICE CREAM SPADE.....	380
ICE MOLDS.....	349

**J**

JIGGERS.....	352
JUICE DISPENSERS, BASES & ACCESSORIES.....	169, 184-189

**K**

KNIVES.....	59, 193, 197, 358
-------------	-------------------

**L**

LADLES.....	379
LEMON LIME PEELER.....	359

LEMON LIME SQUEEZER..... 359  
 LOBSTER/NUT CRACKERS ..... 160  
 LONG PANS.....417

**M**

MALT CUP ..... 351  
 MARKERS ..... 321  
 MARKET TRAYS..... 176-177, 219  
 MEASURING CUPS & SPOONS..... 382-383  
 MEGA SCREENS, DISKS & PANS ..... 403  
 MENU HOLDERS.....161, 322-323  
 MINI COOKWARE..... 54-55  
 MINT JULEP CUPS..... 73, 342  
 MIXING BOWLS ..... 392  
 MIXING GLASSES .....345-351  
 MOROCCAN TUMBLER/BOWLS.... 82, 261, 340, 342  
 MOSCOW MULE MUG .....336-338  
 MUDDLERS..... 354-355  
 MUGS.....12, 17, 23, 25, 32, 78, 336-338

**N**

NAPKIN HOLDERS.....262, 287  
 NOODLE BOWLS..... 23, 229  
 NUMBER TENTS ..... 308, 426

**O**

OIL & VINEGAR CRUETS ..... 158  
 OLIVE WOOD .....197, 237, 252-256, 317, 446

**P**

PAELLA PANS .....179, 181  
 PAILS & TUBS..... 74-75, 80, 302-305, 365-369  
 PAN GRIPPERS .....425  
 PANS ..... 78-79, 263, 267, 393-395, 405-418  
 PAPER .....74, 76-77, 431  
 PAPER TOWEL HOLDERS..... 159  
 PARTY TUBS..... 369  
 PEEL RACK .....443  
 PEELS..... 441-446, 448-449  
 PEPPER MILLS .....156-157  
 PERFORATED DISKS..... 403-404  
 PIE PANS.....79, 395  
 PIE ROLLERS..... 423

PITCHERS .....113-117  
 PIZZA CUTTERS..... 437  
 PIZZA CUTTING MATS ..... 439  
 PIZZA DELIVERY BAGS ..... 450-452  
 PIZZA KNIVES & ROCKERS ..... 438  
 PIZZA PANS & TRAYS .....402-419  
 PIZZA RACKS .....440  
 PIZZA SCREENS..... 402-403  
 PIZZA SERVERS.....387, 436, 437  
 PIZZA STANDS..... 432-435  
 PIZZA STONES.....420-421  
 PLASTIC DRINKWARE ..... 332-336  
 PLATE COVERS .....163-166  
 PLATES .....12-13, 15, 17, 19, 22, 25, 29, 32, 35, 39, 43, 45, 46-48,140, 203-204, 214, 223, 250, 289, 419  
 PLATTERS ..... 12-13, 17, 22, 25, 32, 35, 39, 45, 46, 57, 63, 199, 203, 206-208, 213-218, 220, 225, 228, 230-234, 242, 246, 251, 257, 285  
 POPLAR WOOD..... 84, 130  
 PUNCH BOWLS ..... 369

**R**

RAMEKINS ..... 99, 132-143, 161  
 RISERS.....97, 236, 239, 251, 276-298  
 ROLLING PINS ..... 423

**S**

SALT & PEPPER SHAKERS.....147-148, 151-157  
 SANDWICH BOARDS ..... 320, 324  
 SAUCE CUPS..... 12-13, 23, 25, 33, 81, 132-143, 200-202  
 SCOOPS..... 358, 384  
 SCRAPERS..... 385, 423  
 SEAFOOD TRAYS/STANDS.....270-277  
 SEPARATORS ..... 415-417  
 SERVING BOARDS & PEELS ..... 236-241, 244-245, 248-259, 446-449  
 SERVING BOWLS & LIDS.....46-47, 226-227  
 SHAKERS .....146-155, 427-430  
 SICILIAN-STYLE PANS.....417  
 SKIMMERS ..... 389  
 SMOKER POLES ..... 325  
 SOUP CANS..... 72, 105, 431  
 SPOONERS ..... 381  
 SPOONS.....190-195, 357-358, 381

SPREADER.....190-192, 197, 396  
 SPRINGFORM PAN ..... 393  
 SQUARE DEEP DISH PANS.....416-417  
 SQUEEZERS ..... 359  
 STAINLESS STEEL DRINKING VESSELS ... 336-342  
 STANDS ..... 59, 160, 162, 175, 178-181, 204, 225, 275-298, 364-365, 432-435  
 STEAK WEIGHTS.....390  
 STORAGE CRATE.....173  
 STRAIGHT-SIDED PANS..... 394, 411-414, 416  
 STRAINER FUNNELS ..... 376  
 STRAINERS.....359, 376, 383, 389  
 STRAW DISPENSER..... 159  
 SYRUP DISPENSER ..... 150

**T**

TABLETOP BOARDS ..... 320  
 TACO HOLDERS .....51-53  
 TAPERED NESTING PANS .....408-411, 417  
 TICKET RACKS.....397  
 TONGS.....127, 190-196, 352, 353, 370, 388  
 TRAYS.....12-13, 15, 46, 48, 78, 122-124, 203, 217, 242, 246, 262-266, 270-276, 305, 361, 367, 418-419  
 TRAY STANDS.....162  
 TRIVETS ..... 59, 182  
 TUBS ..... 74-75, 80, 302-305, 365-369  
 TURNERS.....195, 386-387, 436

**V**

VASES.....122-123, 145

**W**

WALL BOARDS ..... 324  
 WATER BOTTLES..... 110-112, 347-348  
 WHIPS..... 379  
 WINE BUCKET & STANDS .....333, 363-365  
 WINE COOLERS..... 361-364





3708 River Road, Suite 800  
Franklin Park, IL 60131

Phone 708-345-1177  
Fax 708-345-5758  
Toll Free 800-333-9133  
Toll Free Fax 800-333-6046  
Email [info@amnow.com](mailto:info@amnow.com)  
[www.amnow.com](http://www.amnow.com)

© 2024 American Metalcraft, Inc.



TO VIEW THE LATEST AND  
GREATEST PRODUCTS,  
SCAN THE CODE BELOW:

