



NEW BUSINESS PRESENTATIONS

EQUIPMENT INVENTORY CHECKLIST



UPDATED: 7.15.22

PURCHASED ITEMS CHECKLIST

 : PAR FOR INVENTORY QUANTITIES
 : ACTUAL QUANTITY CHECK

14 



2 



40 





38 



6 





8 



12 



6 



50 



14 



16 





8 





3 



12 



3 



16 



6 



20 



PURCHASED ITEMS CHECKLIST

● : PAR FOR INVENTORY QUANTITIES
○ : ACTUAL QUANTITY CHECK

20



○

9



○

30



○

2



○

9

*4 ARE DAMAGED, BUT USEABLE



48"X 12" SHELF

○

8



○

4



○

10



○

2



○

12



○

5



○

16



○

4



○

6

*3 ARE DAMAGED, BUT USEABLE



24"X 12" SHELF

○

5



○

4

Dimension



9.5" 7.5"

○

4

Dimension



9.5" 7.5"

○

6



36"X 12" SHELF

○

PURCHASED ITEMS CHECKLIST

● : PAR FOR INVENTORY QUANTITIES
○ : ACTUAL QUANTITY CHECK

2 **○**



4 **○**



3 **○**



3 **○**



4 **○**



3 **○**



4 **○**



16 **○**



5 **○**



4 **○**



4 **○**



2 **○**



18 **○**



2 **○**



15 **○**



96 **○**



1 **○**



7 **○**



PURCHASED ITEMS CHECKLIST

● : PAR FOR INVENTORY QUANTITIES
○ : ACTUAL QUANTITY CHECK

6



○

13



○

6

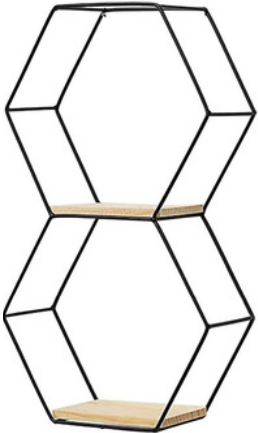

○

3



○

1



○

6



○

2



○

2



○

1



○

2



○

1



○

3



○

2



○

4



○

2



○

1



○

1



○

20





○

PURCHASED ITEMS CHECKLIST

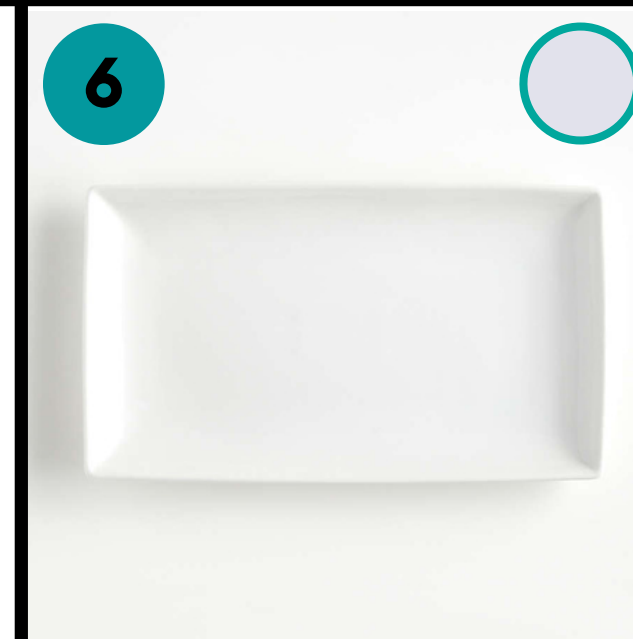
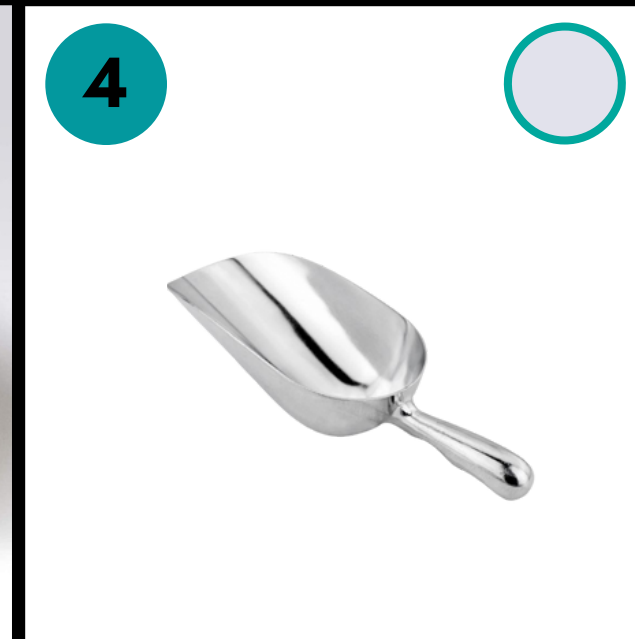
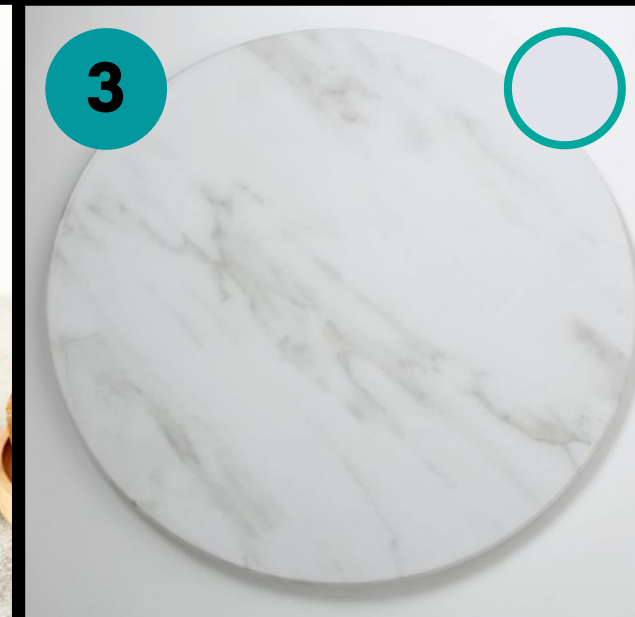
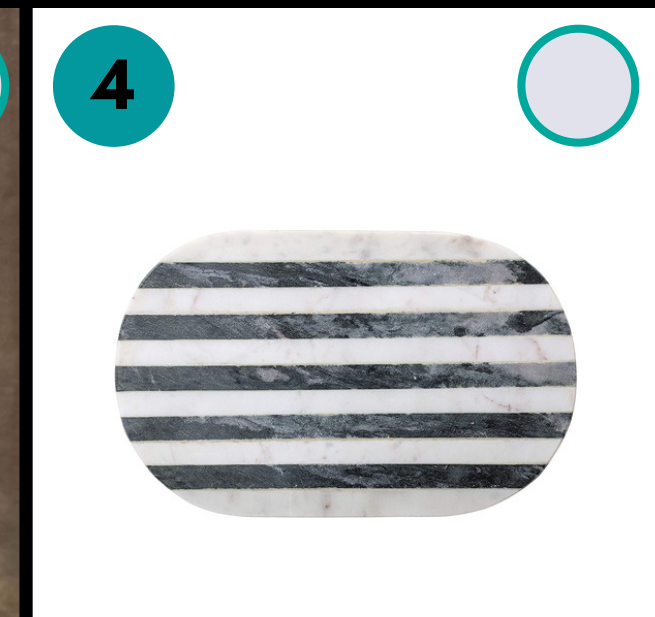
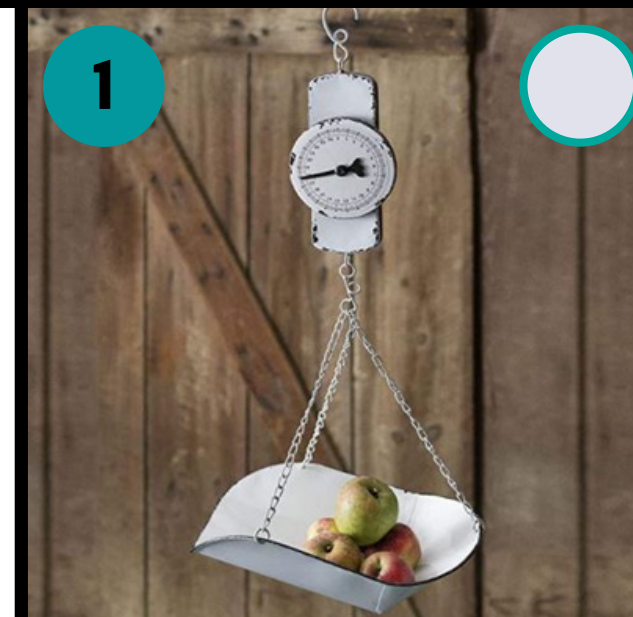
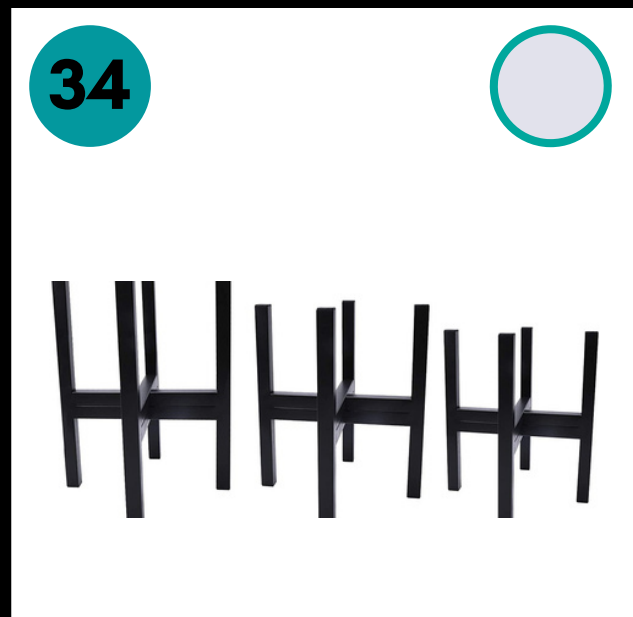
● : PAR FOR INVENTORY QUANTITIES
○ : ACTUAL QUANTITY CHECK



PURCHASED ITEMS CHECKLIST

 : PAR FOR INVENTORY QUANTITIES
 : ACTUAL QUANTITY CHECK

2 



16 





12 



24 





3 



1 



2 



9 





48 



8 



2 



1 



1 



2 



2 



6 



2 



6 



PURCHASED ITEMS CHECKLIST

● : PAR FOR INVENTORY QUANTITIES

○ : ACTUAL QUANTITY CHECK

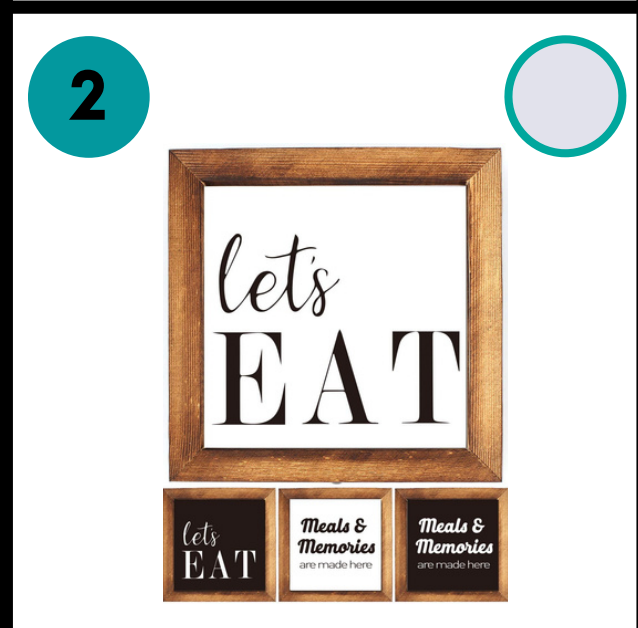
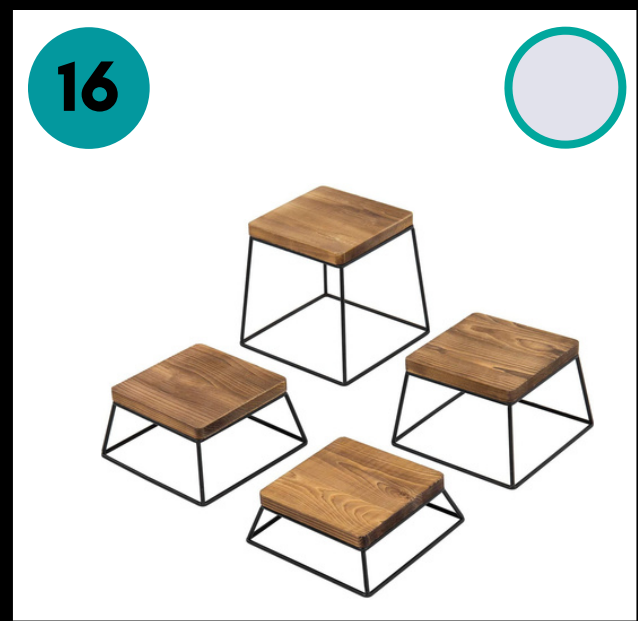
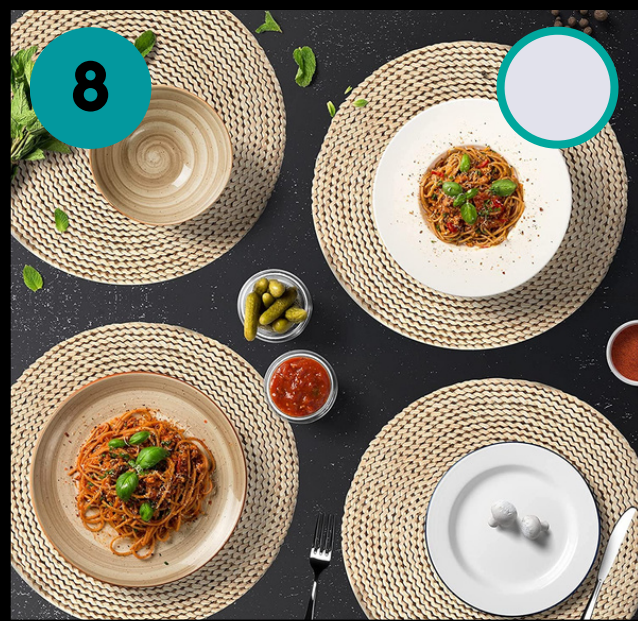
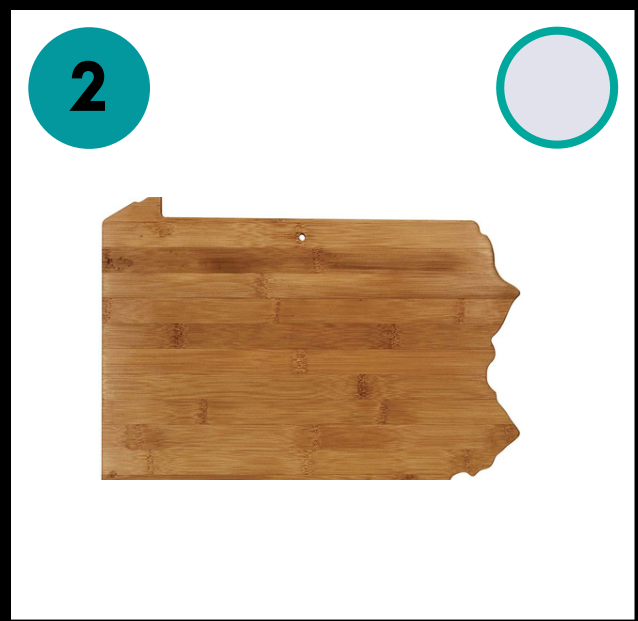

PURCHASED ITEMS CHECKLIST

● : PAR FOR INVENTORY QUANTITIES

○ : ACTUAL QUANTITY CHECK

3



100



42



50



100



50



50



100

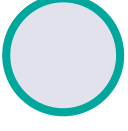

50



6

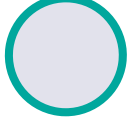

20

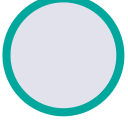

1



2



6

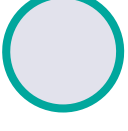

12

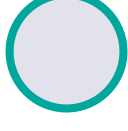

12

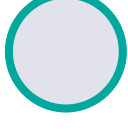

1

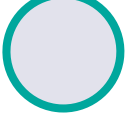

2



PURCHASED ITEMS CHECKLIST

● : PAR FOR INVENTORY QUANTITIES

○ : ACTUAL QUANTITY CHECK

1



4



12



90



6



3



1



200 Pcs Chalkboard Markers
Reusable
Erasable

44



48



48



60

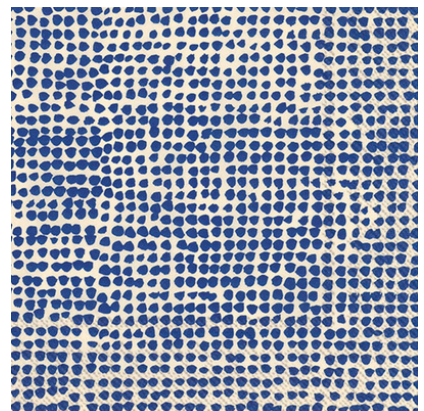

1

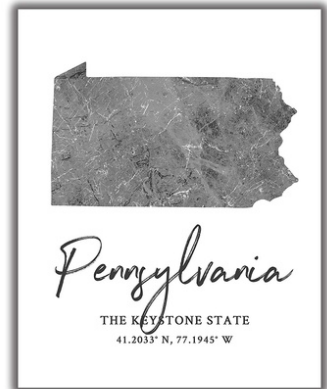

Pennsylvania
THE KEYSTONE STATE
41.3033° N, 77.1945° W

30

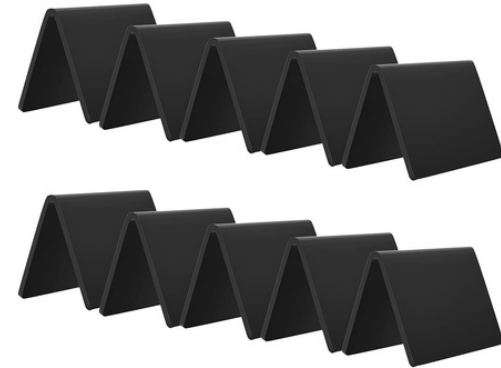

10

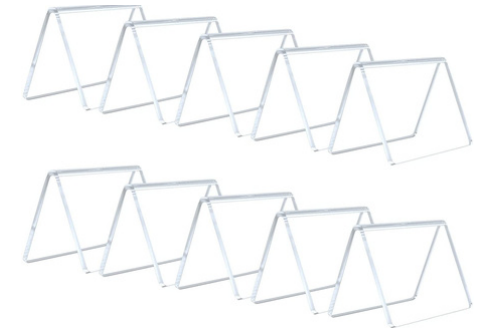

60

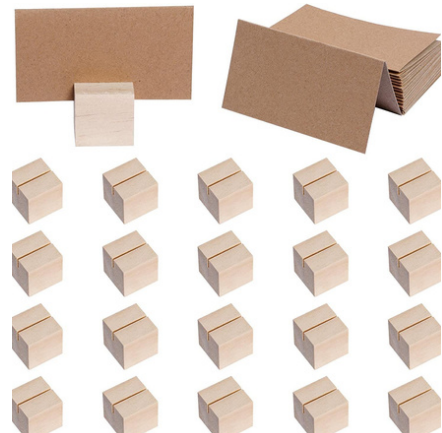

3



1



2



PURCHASED ITEMS CHECKLIST

● : PAR FOR INVENTORY QUANTITIES
○ : ACTUAL QUANTITY CHECK

2 ○

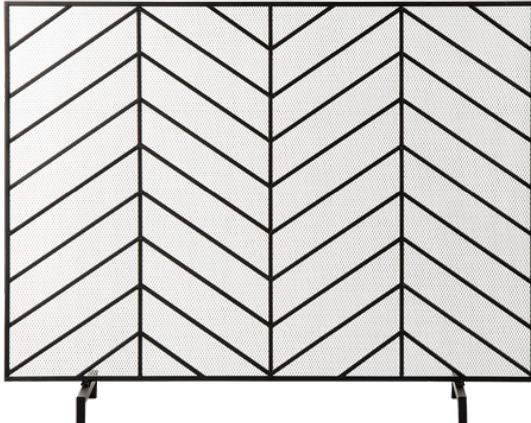

1 ○



1 ○



2 ○

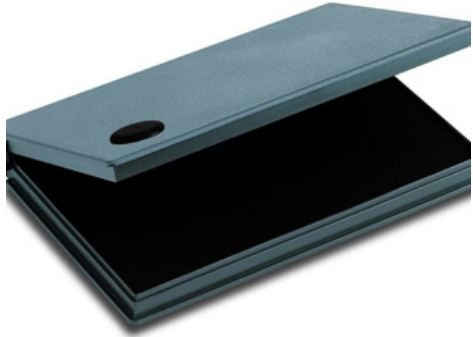

1 ○



4 ○

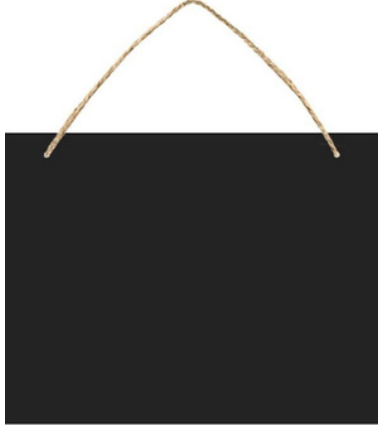

2 ○



50 ○



10 ○

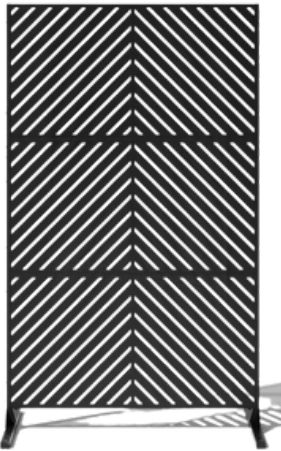

4 ○



3 ○



3 ○

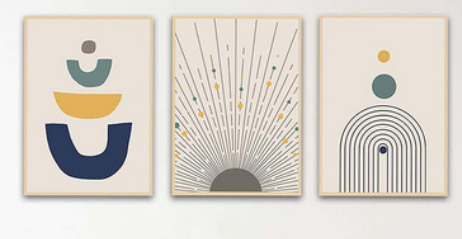

4 ○

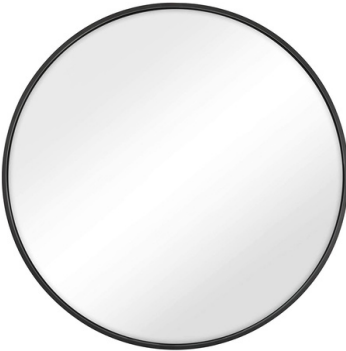

20 ○



4 ○



21 ○



4 ○





8 ○





PURCHASED ITEMS CHECKLIST

● : PAR FOR INVENTORY QUANTITIES
○ : ACTUAL QUANTITY CHECK

4  

1  



15  



2  



3  

3  

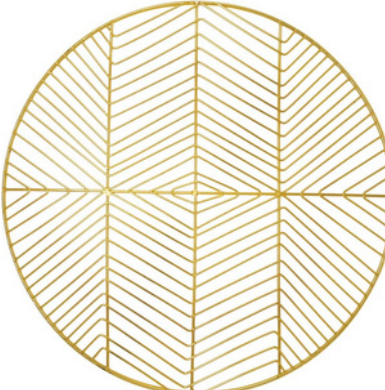

36  

6  

12  

20  

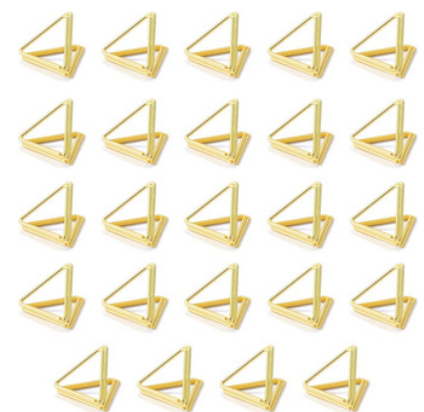
32  

24  

2  

20  

30  

- 

- 

- 

MISC. TOOLS AND SUPPLIES

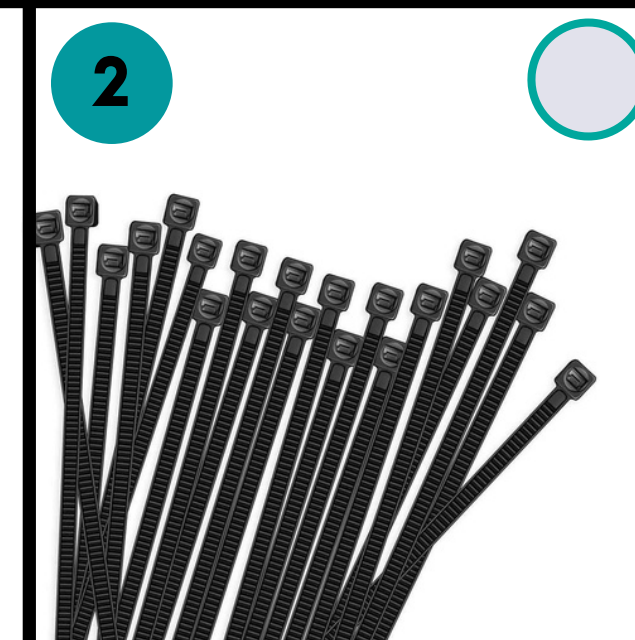
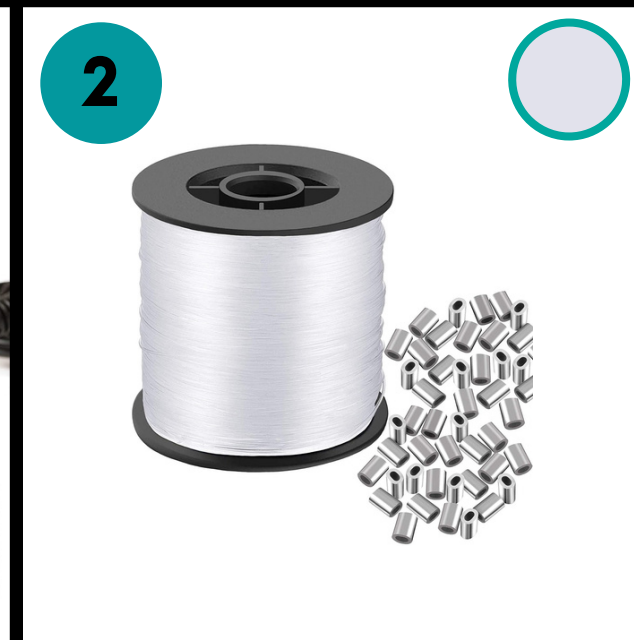
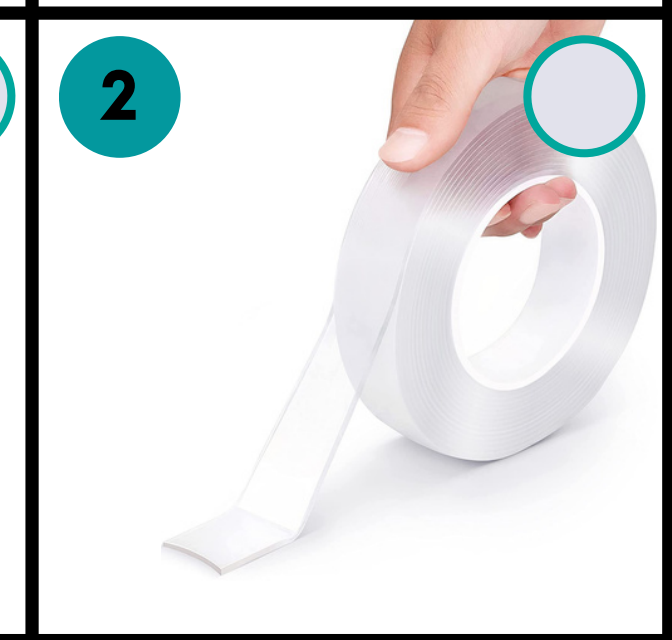
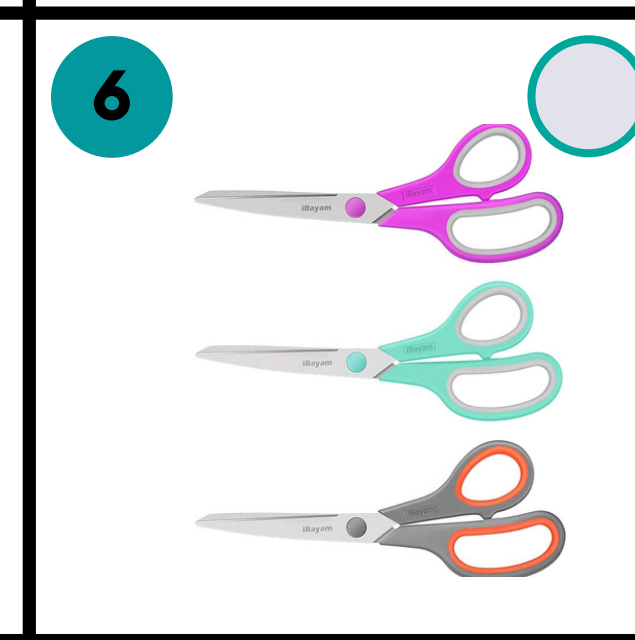
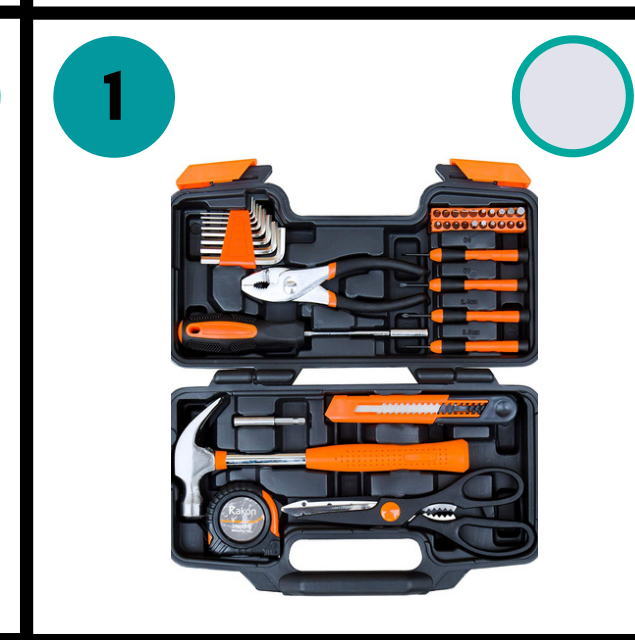
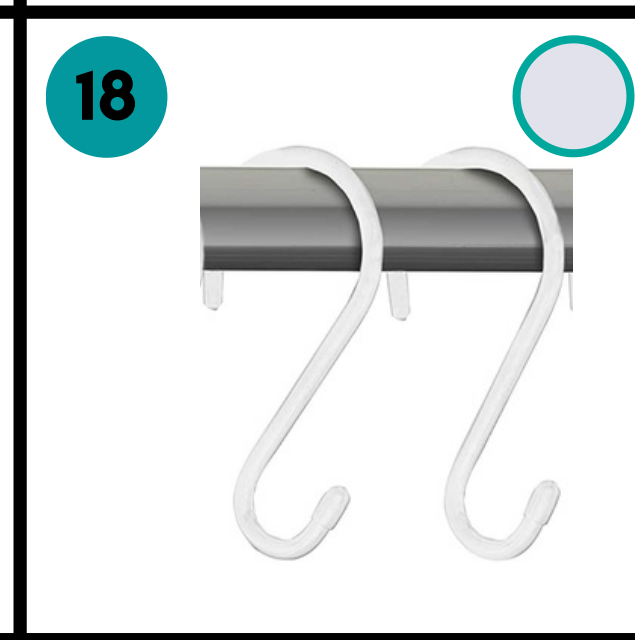
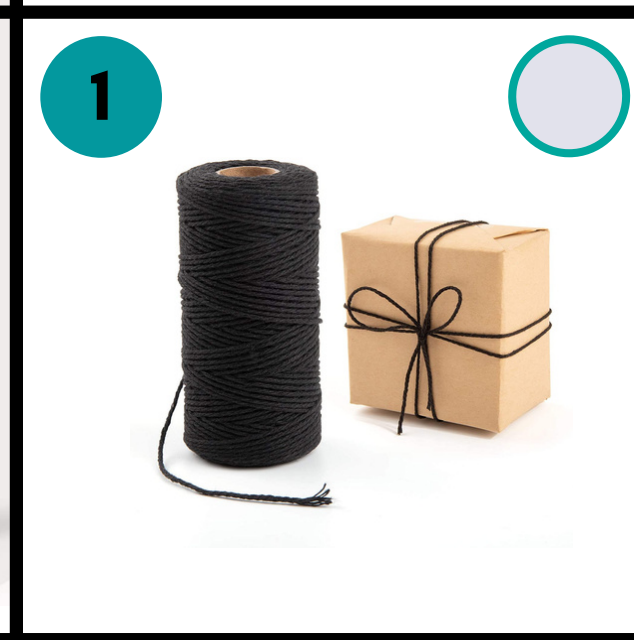
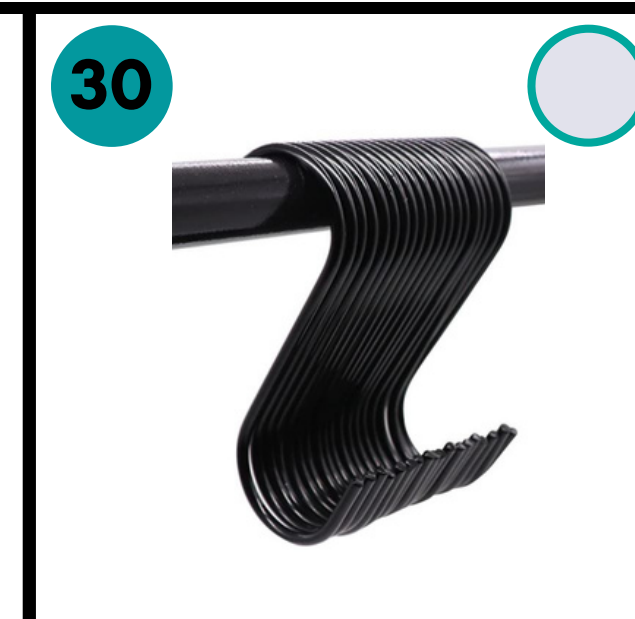
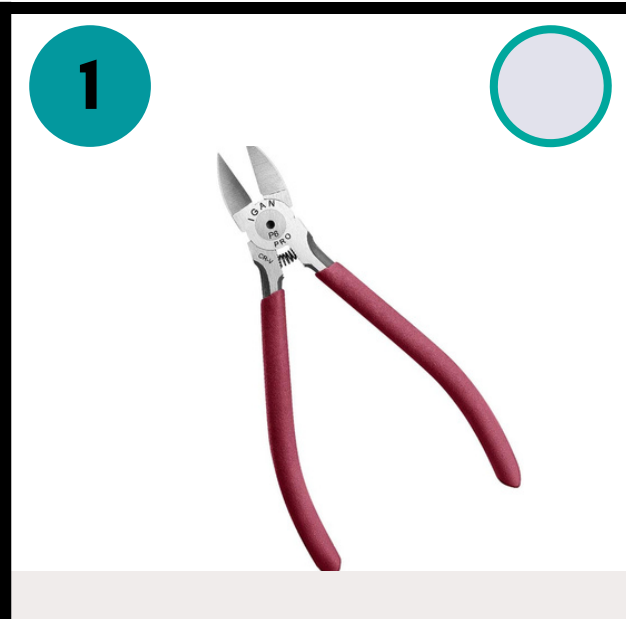

SOME ITEMS MAY NEED TO BE REPLENISHED WITH EACH PRESENTATION

● : PAR FOR INVENTORY QUANTITIES
 ○ : ACTUAL QUANTITY CHECK



MISC. TOOLS AND SUPPLIES

SOME ITEMS MAY NEED TO BE REPLENISHED WITH EACH PRESENTATION

 : PAR FOR INVENTORY QUANTITIES
 : ACTUAL QUANTITY CHECK

1  





1  





1  







1  







30  







-  



-  



-  



-  



-  



-  



-  



-  

-  

-  

-  

-  

-  

SIGNAGE

SOME ITEMS MAY NEED TO BE REPLENISHED WITH EACH PRESENTATION

 : PAR FOR INVENTORY QUANTITIES

 : ACTUAL QUANTITY CHECK

20 

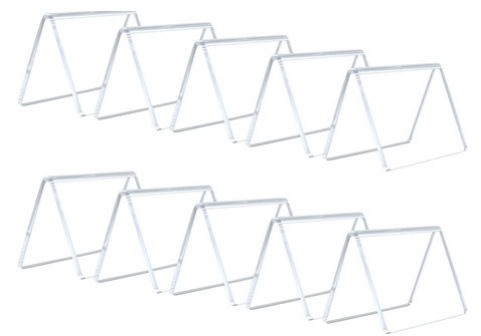

60 





48 

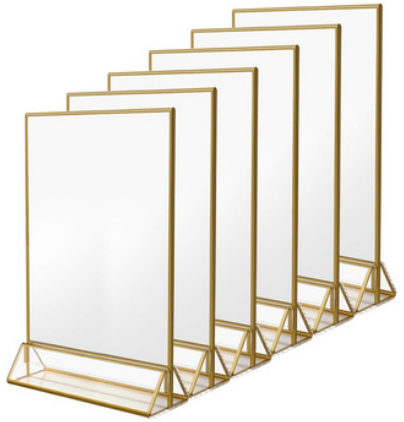

6 



12 



40 



30 

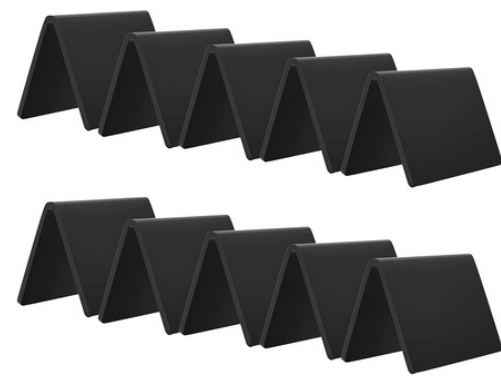

16 

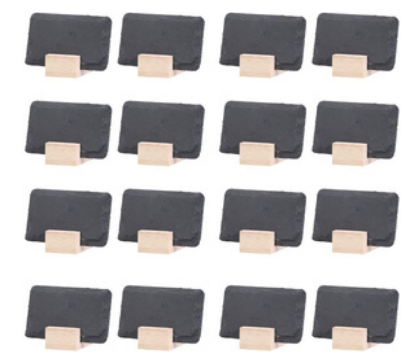

2 



120 





15 



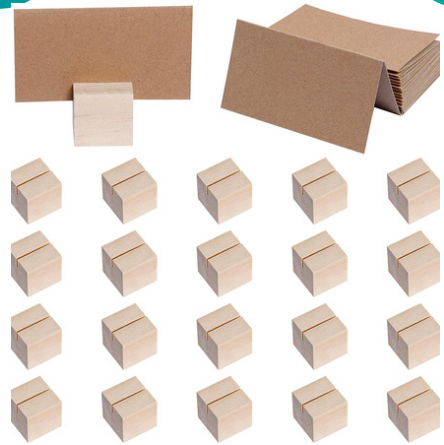

60 





- 

- 

- 

- 

- 

- 

PACKING ITEMS

MOST ITEMS WILL NEED TO BE REPLENISHED WITH EACH PRESENTATION
SUGGESTED PARS WITH PRODUCT LINKS BELOW

 : PAR FOR INVENTORY QUANTITIES

 : ACTUAL QUANTITY CHECK

<p>3  </p> 	<p>4  </p> 	<p>5  </p> 	<p>8  </p> 	<p>6  </p> 	<p>2  </p> 
<p>12  </p> 	<p>24  </p> 	<p>3  </p> 	<p>1  </p> 	<p>-  </p>	<p>-  </p>
<p>-  </p>	<p>-  </p>	<p>-  </p>	<p>-  </p>	<p>-  </p>	<p>-  </p>

NEW BUSINESS
PRESENTATIONS

ITEMS
NEEDING
REPLACING
WITH EACH
PRESENTATION

ITEMS TO RE-PURCHASE WITH EACH PRESENTATION

● : PAR FOR INVENTORY QUANTITIES
 ○ : ACTUAL QUANTITY CHECK

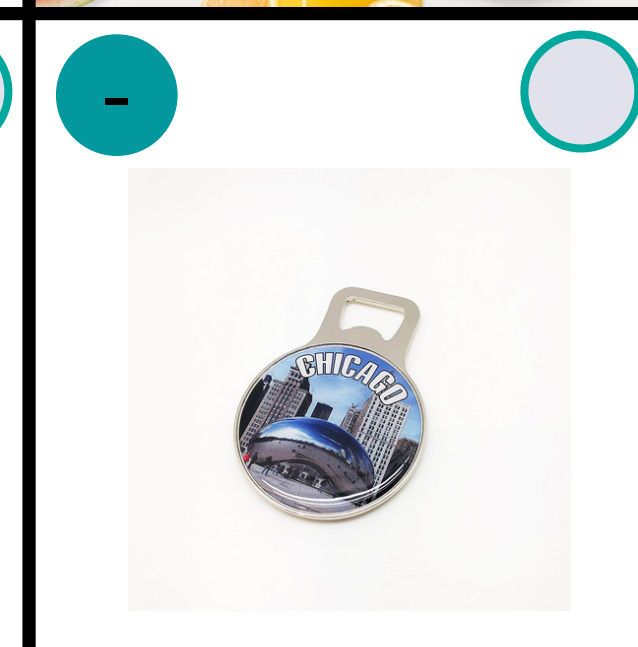
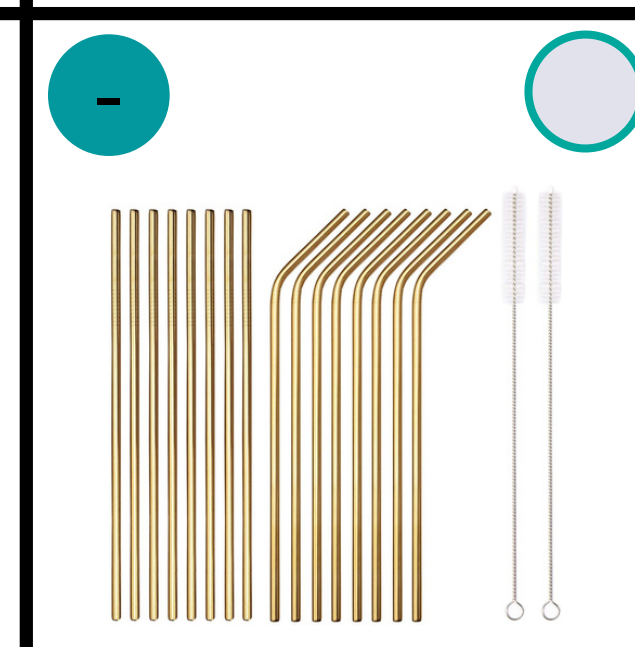
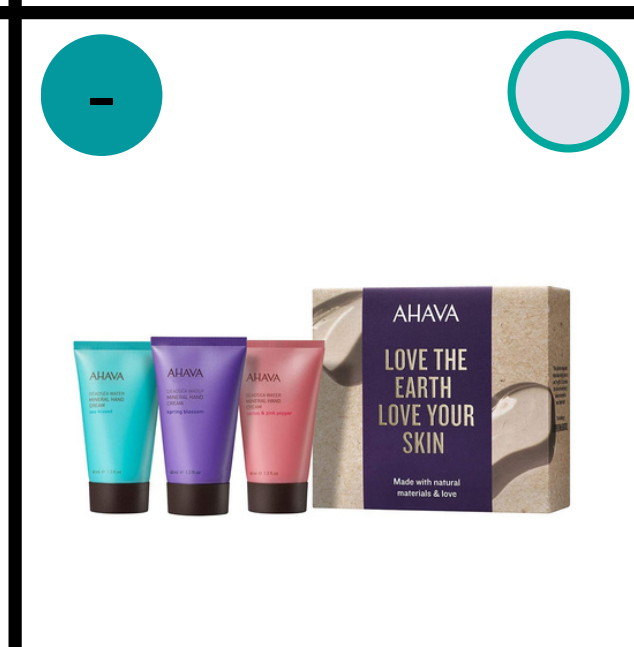
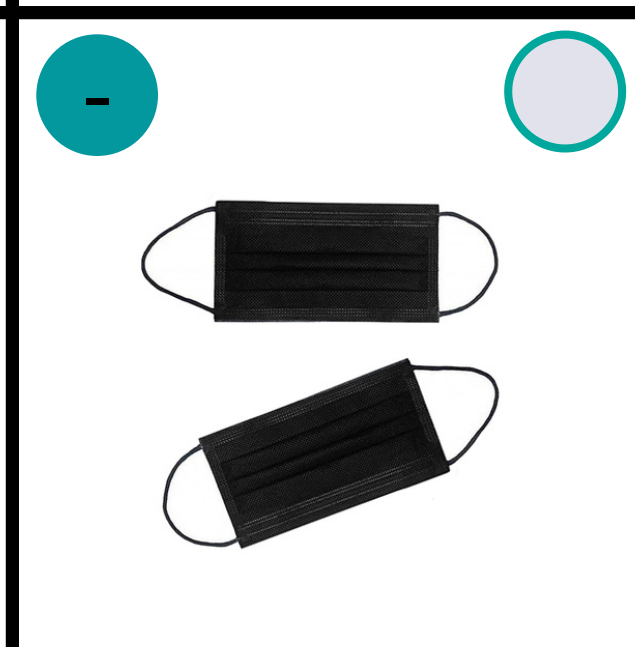
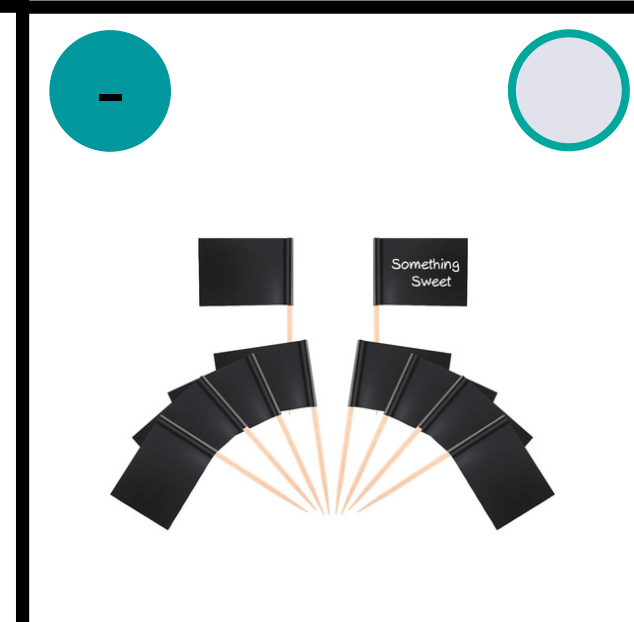
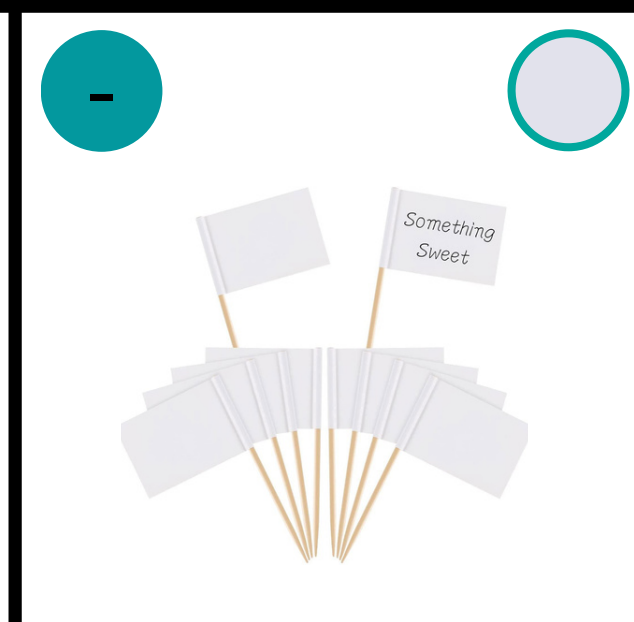
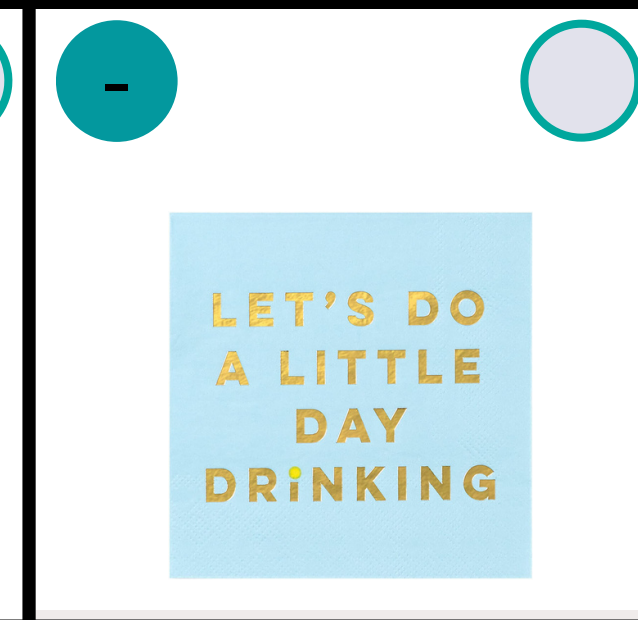
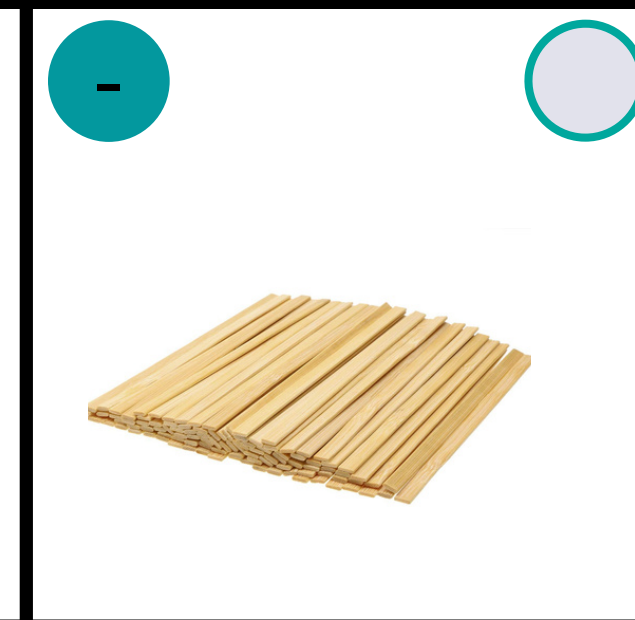

ITEMS TO RE-PURCHASE WITH EACH PRESENTATION

● : PAR FOR INVENTORY QUANTITIES
 ○ : ACTUAL QUANTITY CHECK

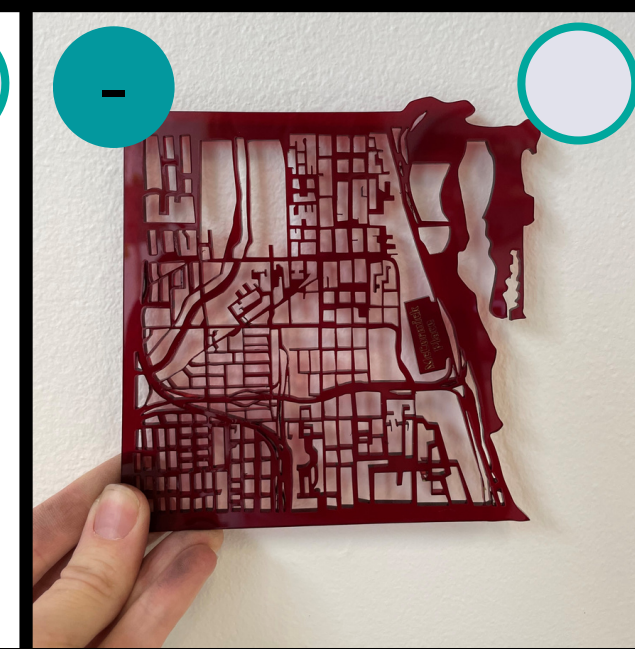
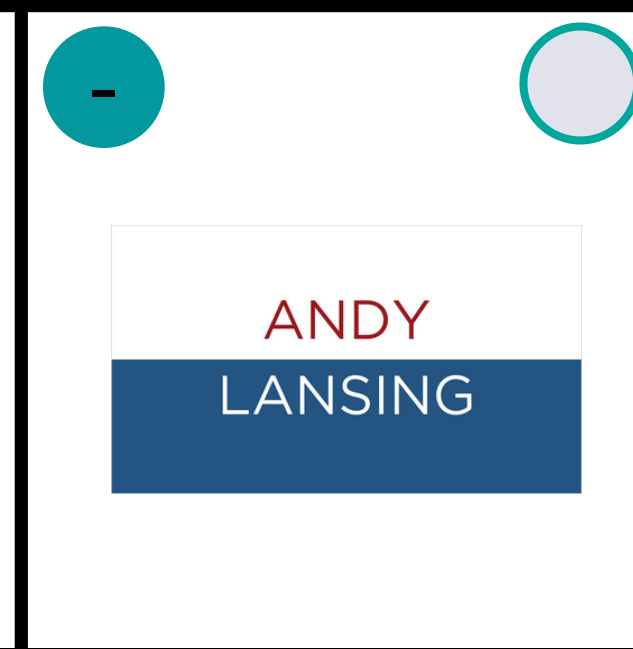
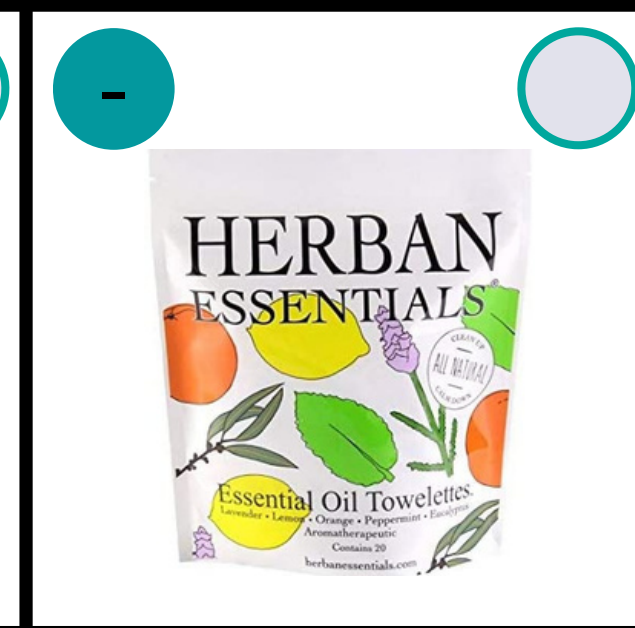
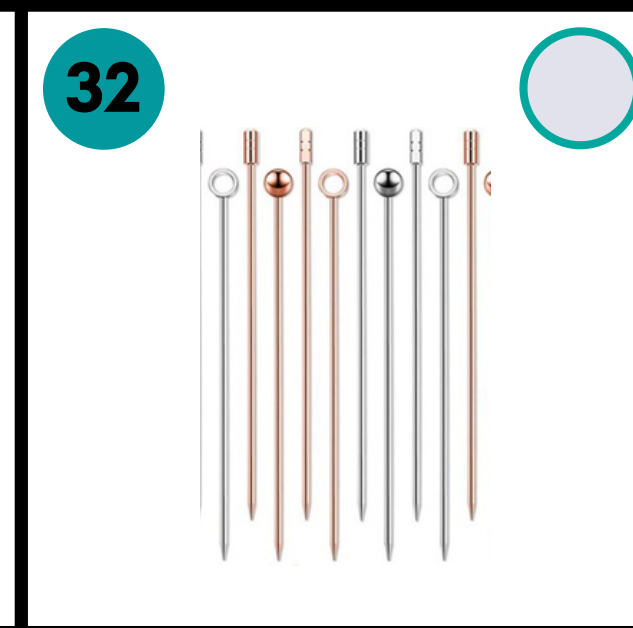
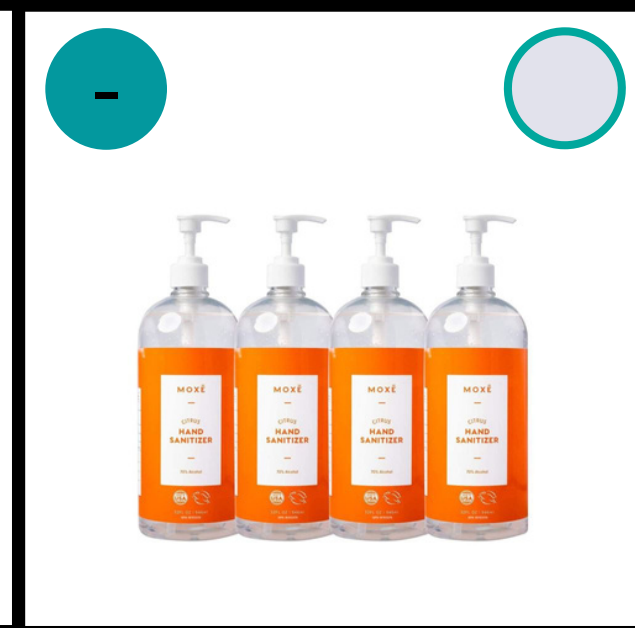
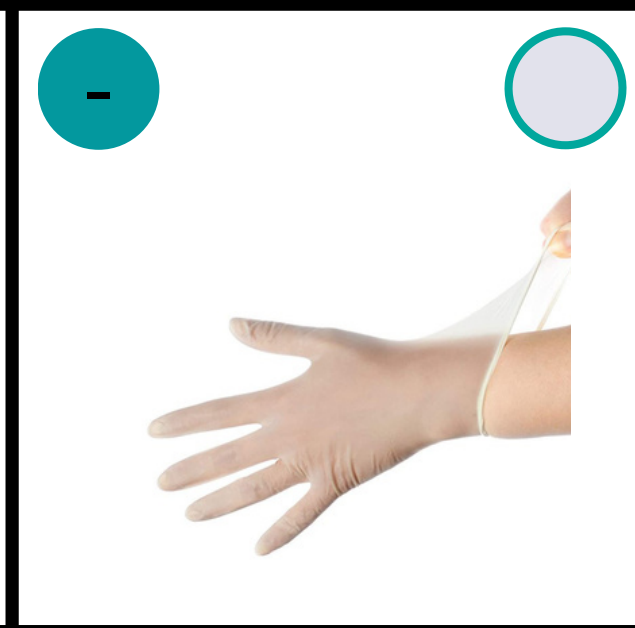
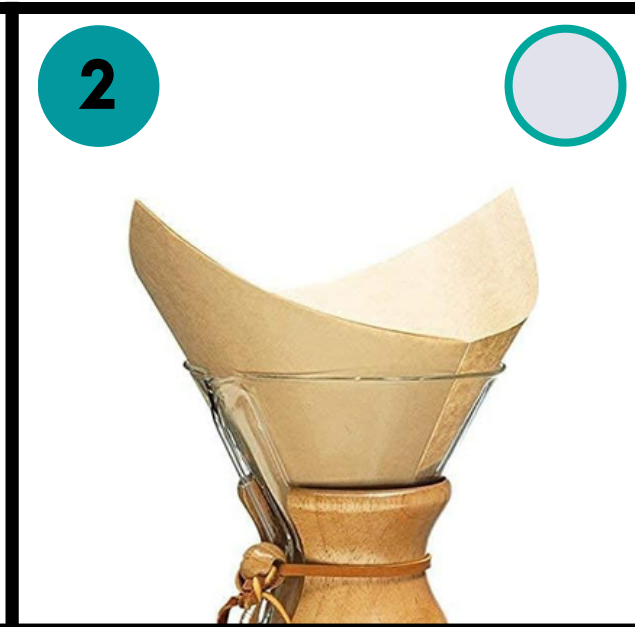

ITEMS TO RE-PURCHASE WITH EACH PRESENTATION

● : PAR FOR INVENTORY QUANTITIES
 ○ : ACTUAL QUANTITY CHECK

- ○



- ○



- ○



24 ○



- ○



- ○

SANITIZATION Station



YOUR COMFORT AND WELL-BEING IS
Our Priority
 PLEASE FEEL FREE TO USE
 OUR COMPLIMENTARY
 HEALTH & SANITIZER ITEMS,
 BEFORE ENTERING INTO MEAL LINES

- ○



- ○

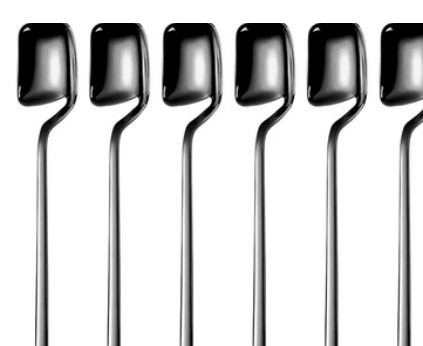

- ○



8 ○



2 ○



200 Pcs 2" Chalkboard
 Reusable
 Erasable

- ○



- ○

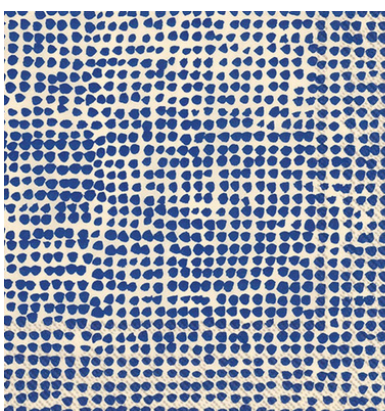

- ○



- ○



32 ○

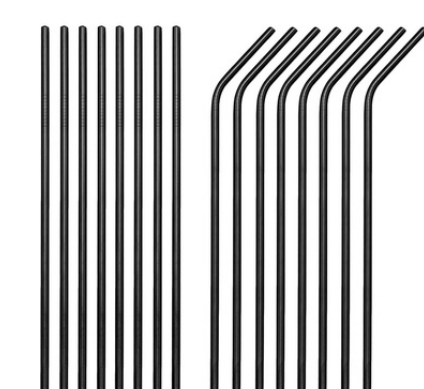

100 ○



- ○

ITEMS NEEDING TO BE PURCHASED

● : PAR FOR INVENTORY QUANTITIES
○ : ACTUAL QUANTITY CHECK

2

○

100

○

18

○

50

○

2



2



4



4



1



4



2

○

4

○

1



2

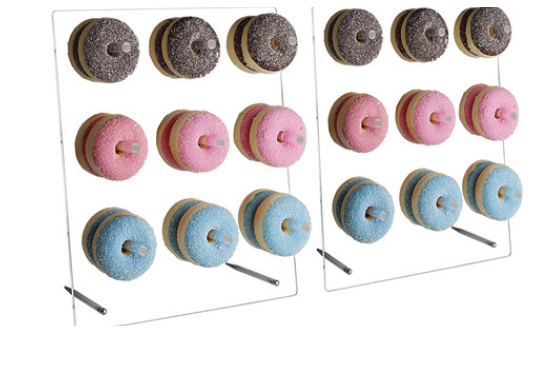

2



2



2



4



ITEMS NEEDING TO BE PURCHASED

● : PAR FOR INVENTORY QUANTITIES
○ : ACTUAL QUANTITY CHECK

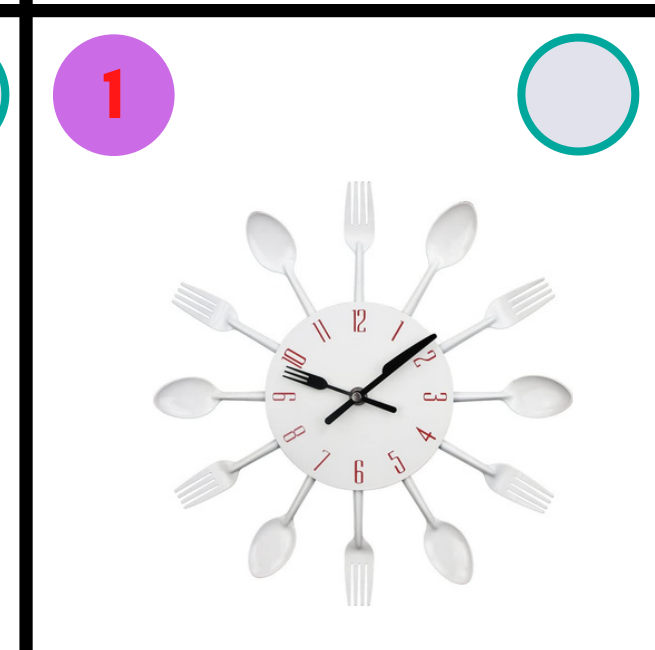
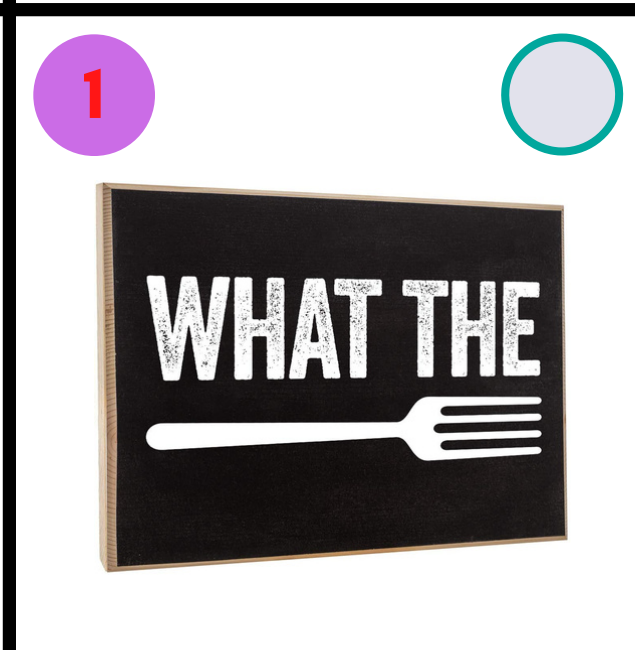
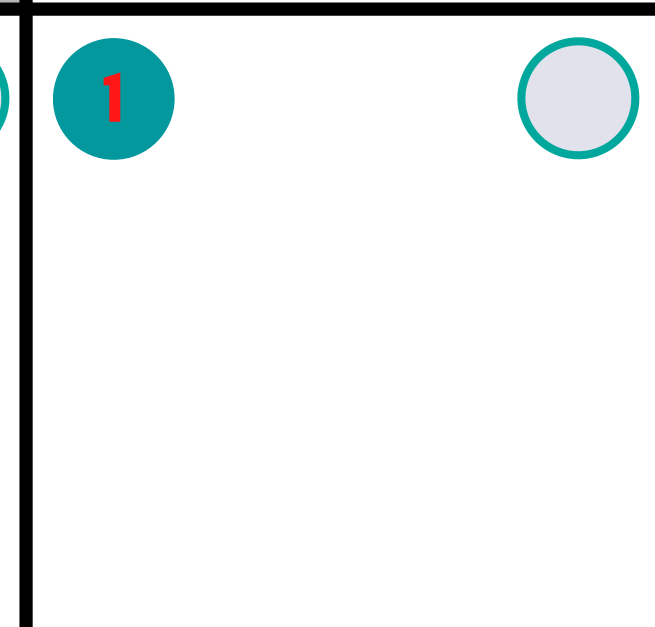
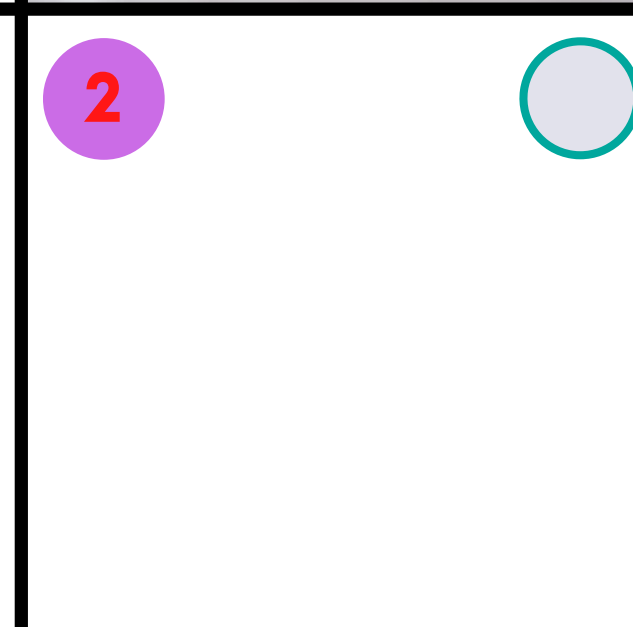
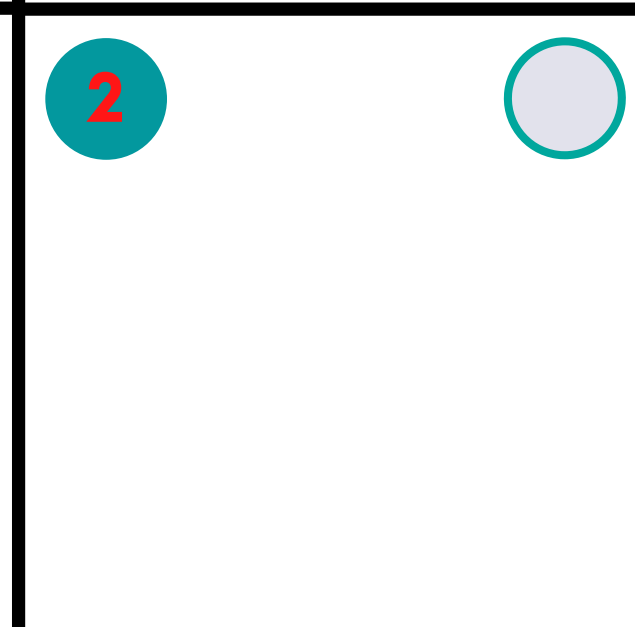
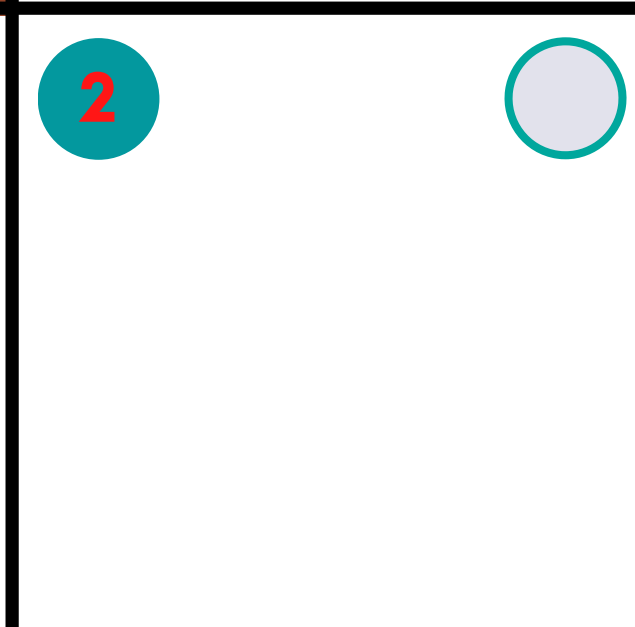
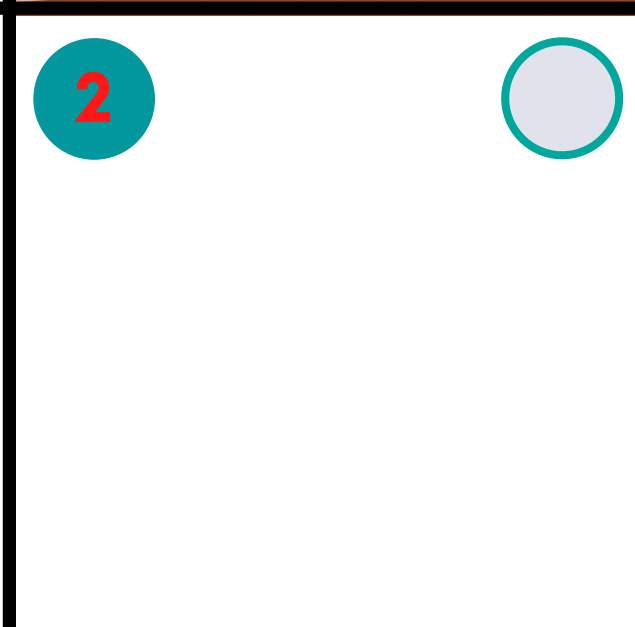
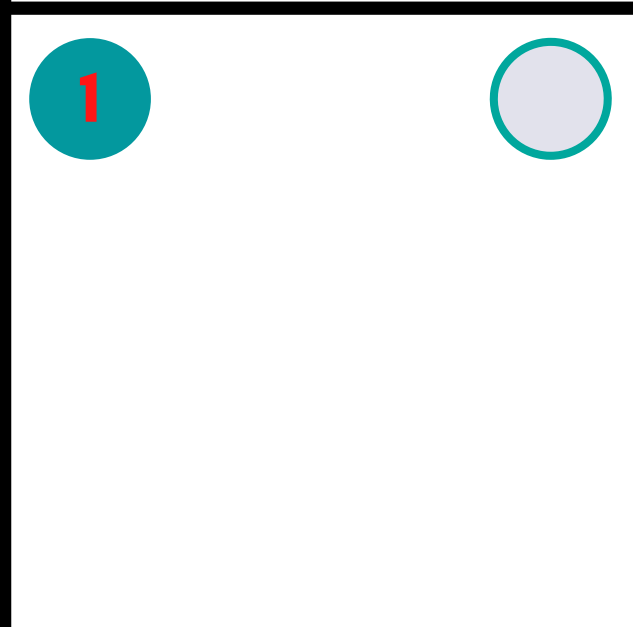
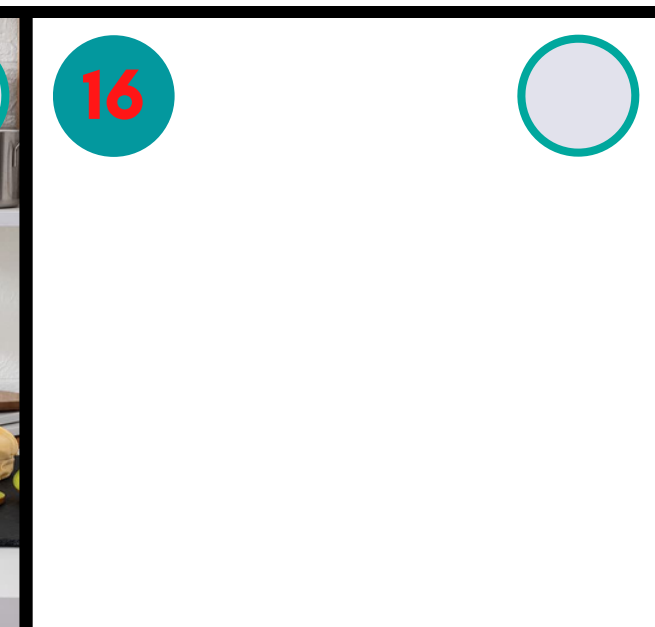
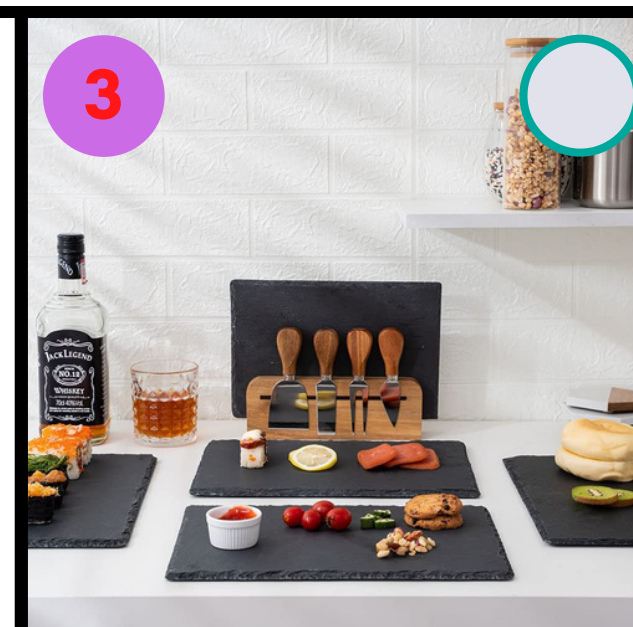
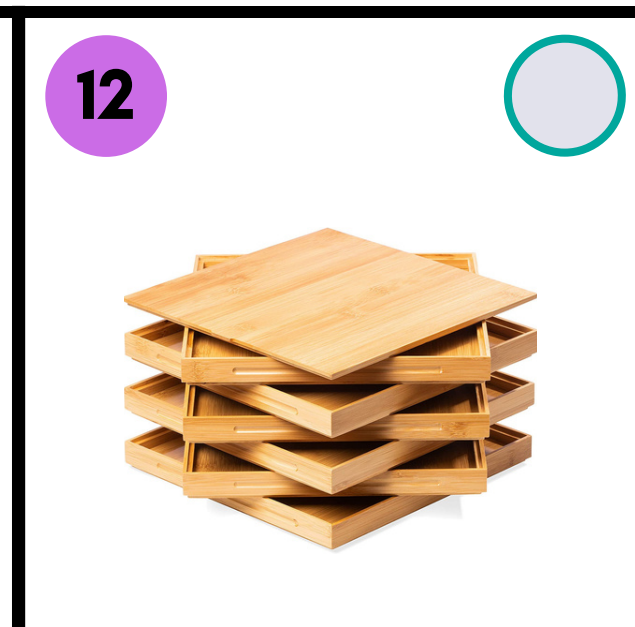
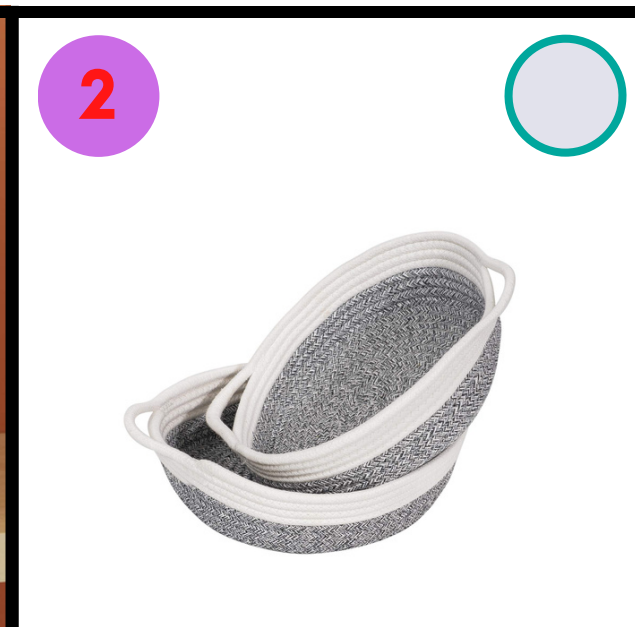

ITEMS NEEDING TO BE PURCHASED

● : PAR FOR INVENTORY QUANTITIES
○ : ACTUAL QUANTITY CHECK

2



○

4

○

2

○

2



○

1



○

1



○

3



○

1



○

2



○

6



○

2



○

2



○

16



○

4

○

6



○

1



○

3



○

2



○

ADDITIONAL ITEMS TO PURCHASE AND ADD TO PRESENTATION INVENTORY

● : PAR FOR INVENTORY QUANTITIES
○ : ACTUAL QUANTITY CHECK

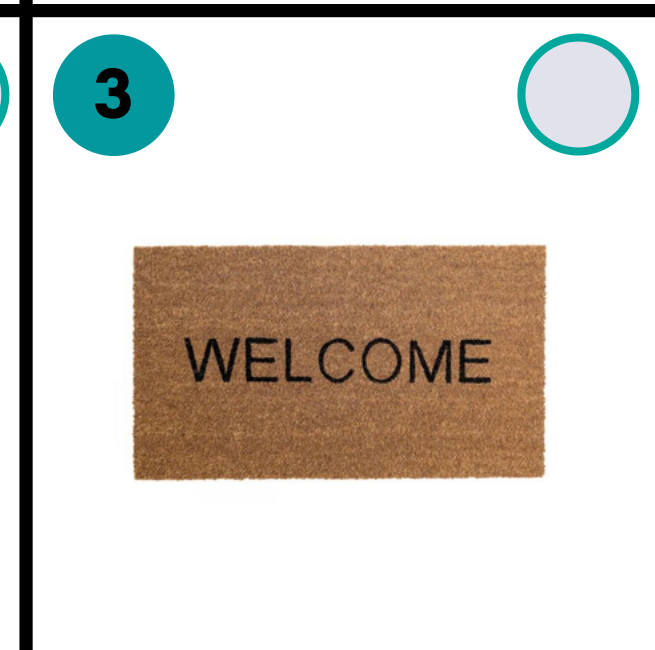
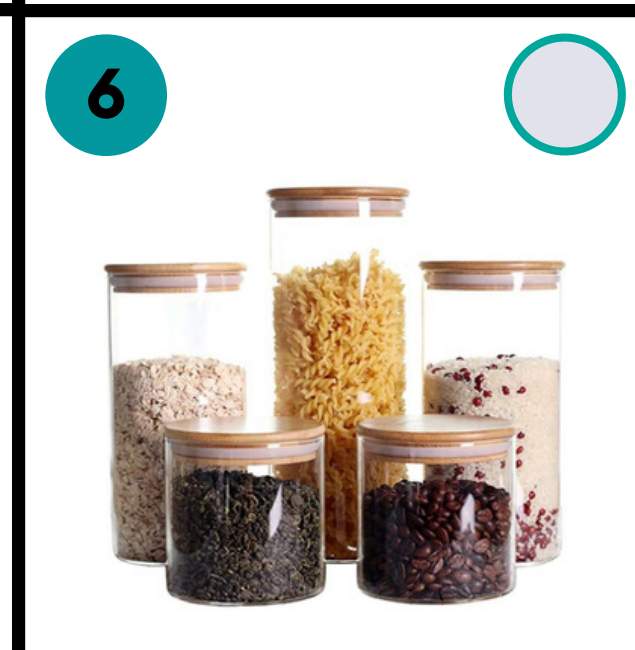
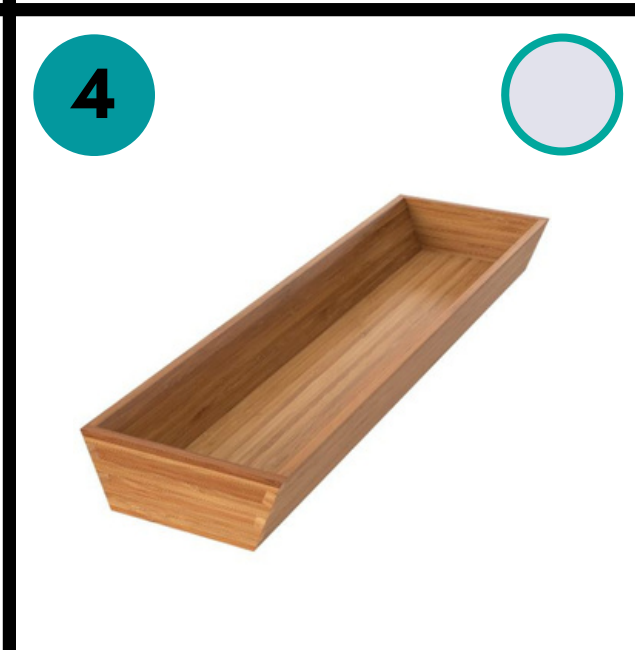
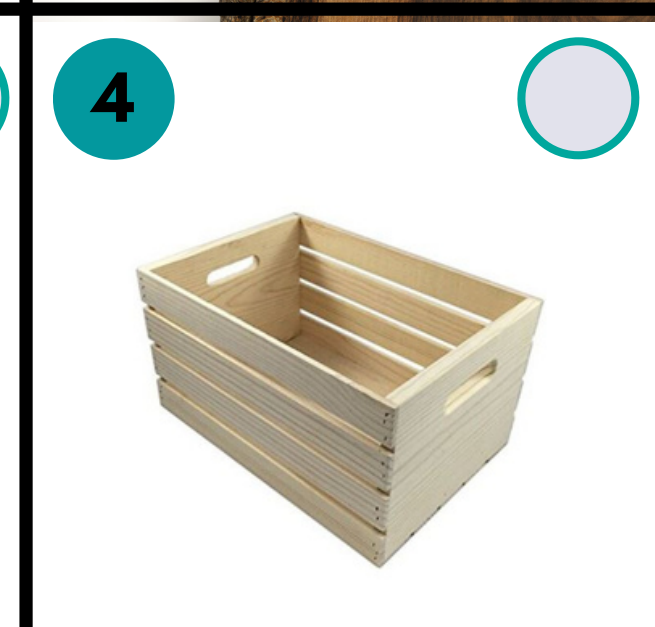
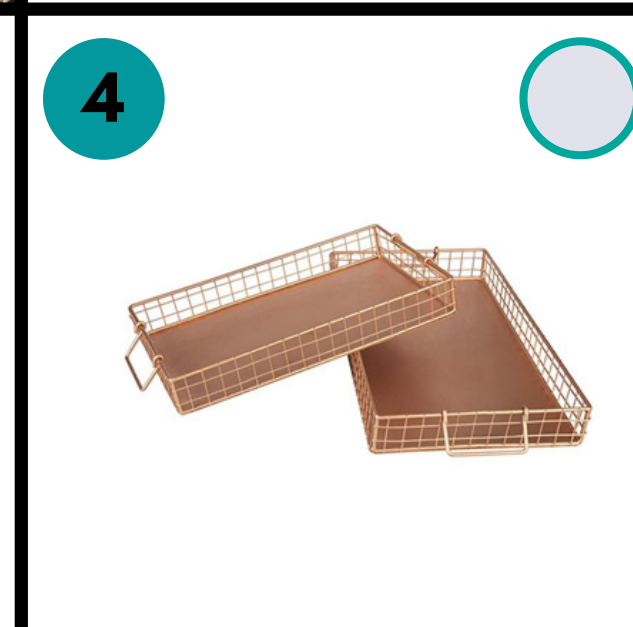
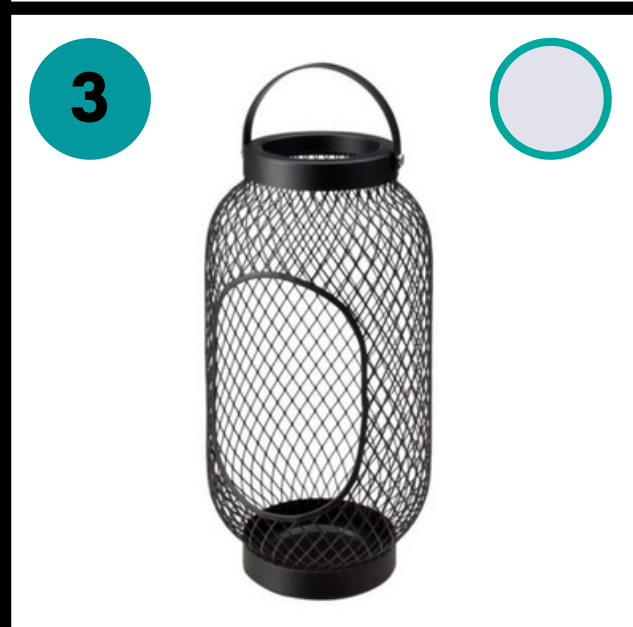
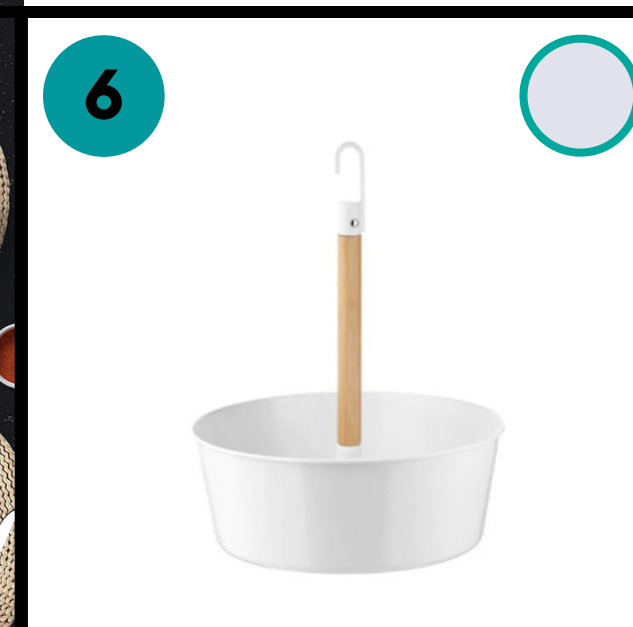
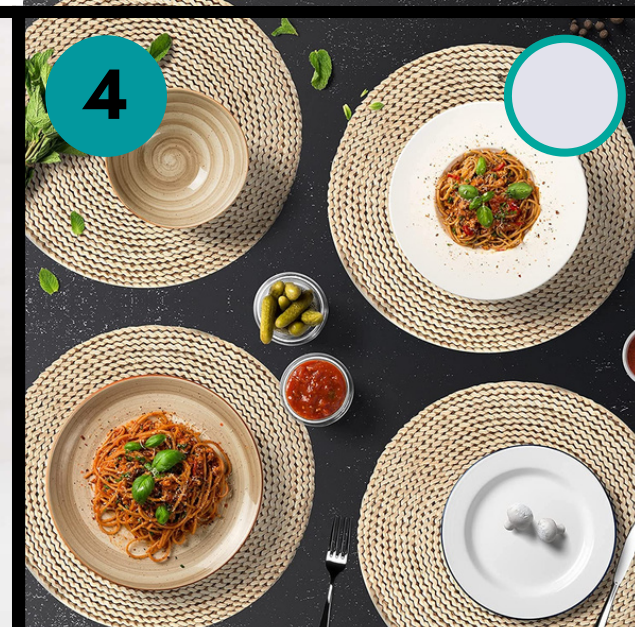
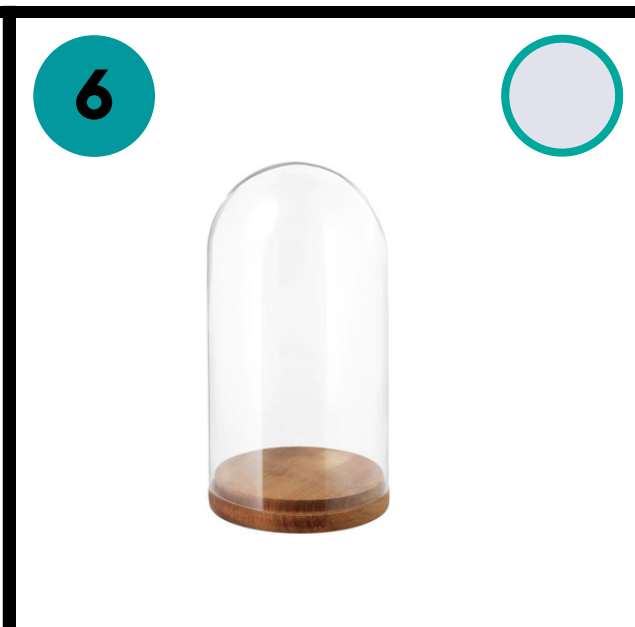
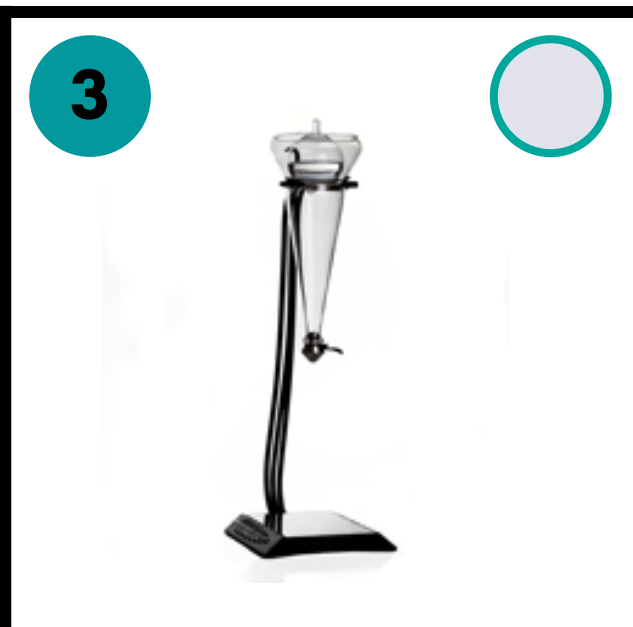

ADDITIONAL ITEMS TO PURCHASE AND ADD TO PRESENTATION INVENTORY

● : PAR FOR INVENTORY QUANTITIES
○ : ACTUAL QUANTITY CHECK

